





Codice assieme	Descrizione assieme	Immagine assieme
ASM2853B/0.D00	Camera di cottura	
ASM2854A/0.D00	Copertura esterna	
ASM4081A/0.D00	Porta	
ASM4102A/0.D00	Assieme generico	

ASM2853B/0.D00 - Camera di cottura

FRONTE

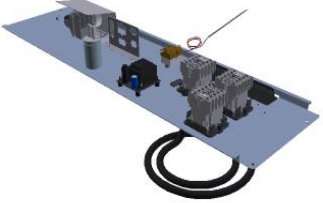
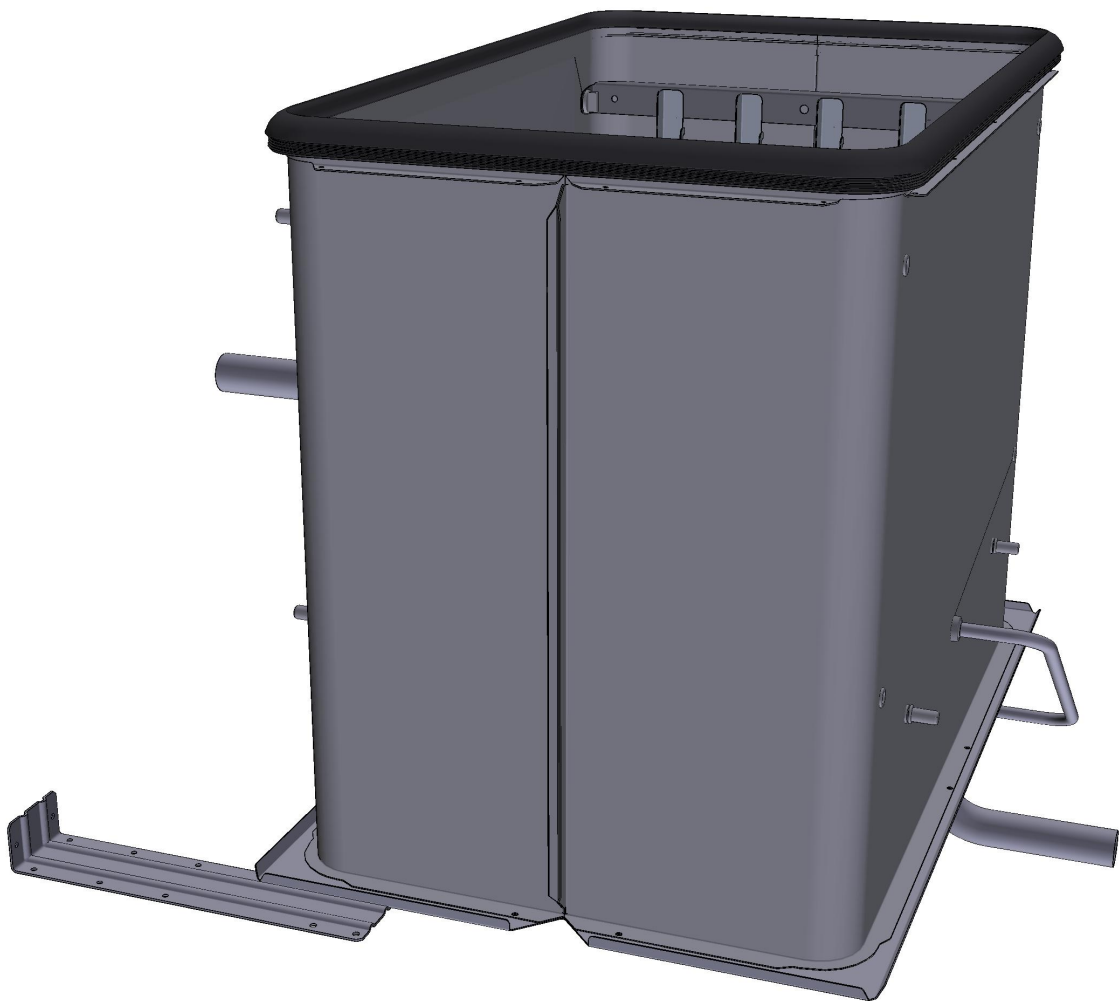



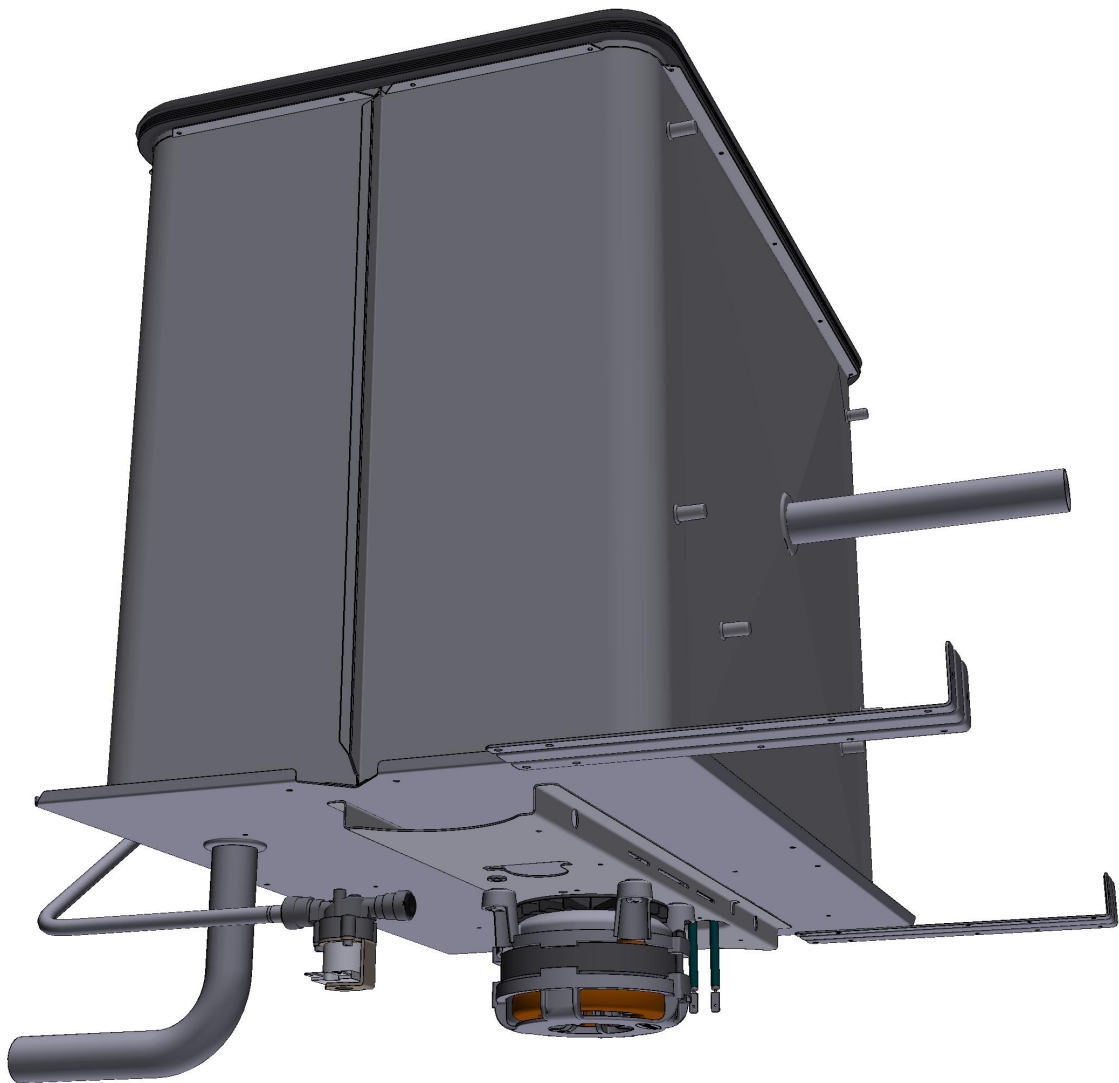

ASM2853B/0.D00 - Camera di cottura

RETRO





COMPONENTE			RICAMBIO																										
Codice	Descrizione	Immagine	Codice	Descrizione	Lista componenti																								
RC1170A	DADO M14 H=8 CH=22 INOX		KRC1170A	KIT 10 DADI M14 H8 CH22 INOX	<table border="1"> <thead> <tr> <th>Codice</th> <th>Descrizione</th> <th>Qtà</th> <th>UM</th> </tr> </thead> <tbody> <tr> <td>RC1170A1</td> <td>DADO M14 H=8 CH=22 INOX</td> <td>10</td> <td>PZ</td> </tr> <tr> <td>VM1224A0</td> <td>TUBOLARE TERMORETR 65MY 220MM 2 COLORI</td> <td>0.200</td> <td>M</td> </tr> </tbody> </table>	Codice	Descrizione	Qtà	UM	RC1170A1	DADO M14 H=8 CH=22 INOX	10	PZ	VM1224A0	TUBOLARE TERMORETR 65MY 220MM 2 COLORI	0.200	M												
Codice	Descrizione	Qtà	UM																										
RC1170A1	DADO M14 H=8 CH=22 INOX	10	PZ																										
VM1224A0	TUBOLARE TERMORETR 65MY 220MM 2 COLORI	0.200	M																										
0H4820A	STAFFA SOSTEGNO BULBO DA LAV.		0H4820A1	STAFFA SOSTEGNO BULBO DA LAV.																									
GN1531A	GUARNIZIONE TENUTA INGRESSO BULBO		KTR1136A	KIT TERMOSTATO SICUREZZA 330°C	<table border="1"> <thead> <tr> <th>Codice</th> <th>Descrizione</th> <th>Qtà</th> <th>UM</th> </tr> </thead> <tbody> <tr> <td>0H7030A0</td> <td>COPERCHIO INGRESSO BULBO</td> <td>1</td> <td>PZ</td> </tr> <tr> <td>GN1531A0</td> <td>GUARNIZIONE TENUTA INGRESSO BULBO</td> <td>1</td> <td>PZ</td> </tr> <tr> <td>SL1045A0</td> <td>SILICONE ANTRACITE S57 80 ML</td> <td>1</td> <td>PZ</td> </tr> <tr> <td>TR1136A0</td> <td>TERMOSTATO SIC. UNIP. 330°C</td> <td>1</td> <td>PZ</td> </tr> <tr> <td>VI1220A1</td> <td>VITE AUTOFILETTA NTE 4.2X11 TCS+ MARUTE</td> <td>3</td> <td>PZ</td> </tr> </tbody> </table>	Codice	Descrizione	Qtà	UM	0H7030A0	COPERCHIO INGRESSO BULBO	1	PZ	GN1531A0	GUARNIZIONE TENUTA INGRESSO BULBO	1	PZ	SL1045A0	SILICONE ANTRACITE S57 80 ML	1	PZ	TR1136A0	TERMOSTATO SIC. UNIP. 330°C	1	PZ	VI1220A1	VITE AUTOFILETTA NTE 4.2X11 TCS+ MARUTE	3	PZ
Codice	Descrizione	Qtà	UM																										
0H7030A0	COPERCHIO INGRESSO BULBO	1	PZ																										
GN1531A0	GUARNIZIONE TENUTA INGRESSO BULBO	1	PZ																										
SL1045A0	SILICONE ANTRACITE S57 80 ML	1	PZ																										
TR1136A0	TERMOSTATO SIC. UNIP. 330°C	1	PZ																										
VI1220A1	VITE AUTOFILETTA NTE 4.2X11 TCS+ MARUTE	3	PZ																										
0H7030A	COPERCHIO INGRESSO BULBO		K0H7030A	KIT COPERCHIO INGRESSO BULBO 1PZ	<table border="1"> <thead> <tr> <th>Codice</th> <th>Descrizione</th> <th>Qtà</th> <th>UM</th> </tr> </thead> <tbody> <tr> <td>0H7030A0</td> <td>COPERCHIO INGRESSO BULBO</td> <td>1</td> <td>PZ</td> </tr> <tr> <td>VM1224A0</td> <td>TUBOLARE TERMORETR 65MY 220MM 2 COLORI</td> <td>0.200</td> <td>M</td> </tr> </tbody> </table>	Codice	Descrizione	Qtà	UM	0H7030A0	COPERCHIO INGRESSO BULBO	1	PZ	VM1224A0	TUBOLARE TERMORETR 65MY 220MM 2 COLORI	0.200	M												
Codice	Descrizione	Qtà	UM																										
0H7030A0	COPERCHIO INGRESSO BULBO	1	PZ																										
VM1224A0	TUBOLARE TERMORETR 65MY 220MM 2 COLORI	0.200	M																										

COMPONENTE			RICAMBIO																						
Codice	Descrizione	Immagine	Codice	Descrizione	Lista componenti																				
0H2551A	TAPPO PER TUBO DI SCARICO LIQUIDI INOX C		K0H2551A	KIT TAPPO TUBO DI SCARICO LIQUIDI	<table border="1"> <thead> <tr> <th>Codice</th> <th>Descrizione</th> <th>Qtà</th> <th>UM</th> </tr> </thead> <tbody> <tr> <td>0H2551A0</td> <td>TAPPO PER TUBO DI SCARICO LIQUIDI INOX</td> <td>1</td> <td>PZ</td> </tr> <tr> <td>VM1224A0</td> <td>TUBOLARE TERMORETR 65MY 220MM 2 COLORI</td> <td>0.200</td> <td>M</td> </tr> </tbody> </table>	Codice	Descrizione	Qtà	UM	0H2551A0	TAPPO PER TUBO DI SCARICO LIQUIDI INOX	1	PZ	VM1224A0	TUBOLARE TERMORETR 65MY 220MM 2 COLORI	0.200	M								
					Codice	Descrizione	Qtà	UM																	
0H2551A0	TAPPO PER TUBO DI SCARICO LIQUIDI INOX	1	PZ																						
VM1224A0	TUBOLARE TERMORETR 65MY 220MM 2 COLORI	0.200	M																						
VM1820A	NOTTOLINO M6 CROMATO FISS. SUPPORTI		KVM1820A	KIT 10 NOTTOLINI	<table border="1"> <thead> <tr> <th>Codice</th> <th>Descrizione</th> <th>Qtà</th> <th>UM</th> </tr> </thead> <tbody> <tr> <td>VM1224A0</td> <td>TUBOLARE TERMORETR 65MY 220MM 2 COLORI</td> <td>0.200</td> <td>M</td> </tr> <tr> <td>VM1820A0</td> <td>NOTTOLINO M6 CROMATO FISS. SUPPORTI</td> <td>10</td> <td>PZ</td> </tr> </tbody> </table>	Codice	Descrizione	Qtà	UM	VM1224A0	TUBOLARE TERMORETR 65MY 220MM 2 COLORI	0.200	M	VM1820A0	NOTTOLINO M6 CROMATO FISS. SUPPORTI	10	PZ								
Codice	Descrizione	Qtà	UM																						
VM1224A0	TUBOLARE TERMORETR 65MY 220MM 2 COLORI	0.200	M																						
VM1820A0	NOTTOLINO M6 CROMATO FISS. SUPPORTI	10	PZ																						
GN1326A	GUARNIZIONE RESISTENZA 71X19 G6.25		KRS1274A	KIT RESISTENZA DI FRENATA 100W	<table border="1"> <thead> <tr> <th>Codice</th> <th>Descrizione</th> <th>Qtà</th> <th>UM</th> </tr> </thead> <tbody> <tr> <td>GN1326A1</td> <td>GUARNIZIONE RESISTENZA 71X19 G6.25</td> <td>1</td> <td>PZ</td> </tr> <tr> <td>RS1274A0</td> <td>RESISTENZA PIANA 100W 60V 1 SPIRA</td> <td>1</td> <td>PZ</td> </tr> <tr> <td>SL1045A0</td> <td>SILICONE ANTRACITE S57 80 ML</td> <td>1</td> <td>PZ</td> </tr> <tr> <td>VI1220A1</td> <td>VITE AUTOFILETTA NTE 4.2X11 TCS+ MARUTE</td> <td>2</td> <td>PZ</td> </tr> </tbody> </table>	Codice	Descrizione	Qtà	UM	GN1326A1	GUARNIZIONE RESISTENZA 71X19 G6.25	1	PZ	RS1274A0	RESISTENZA PIANA 100W 60V 1 SPIRA	1	PZ	SL1045A0	SILICONE ANTRACITE S57 80 ML	1	PZ	VI1220A1	VITE AUTOFILETTA NTE 4.2X11 TCS+ MARUTE	2	PZ
					Codice	Descrizione	Qtà	UM																	
					GN1326A1	GUARNIZIONE RESISTENZA 71X19 G6.25	1	PZ																	
					RS1274A0	RESISTENZA PIANA 100W 60V 1 SPIRA	1	PZ																	
					SL1045A0	SILICONE ANTRACITE S57 80 ML	1	PZ																	
			VI1220A1	VITE AUTOFILETTA NTE 4.2X11 TCS+ MARUTE	2	PZ																			
			KRS1261A	KIT RESISTENZA FRENATA 122W	<table border="1"> <thead> <tr> <th>Codice</th> <th>Descrizione</th> <th>Qtà</th> <th>UM</th> </tr> </thead> <tbody> <tr> <td>GN1326A1</td> <td>GUARNIZIONE RESISTENZA 71X19 G6.25</td> <td>1</td> <td>PZ</td> </tr> <tr> <td>RS1261A0</td> <td>RESISTENZA MOTORE BAKERLUX/CH EFLUX</td> <td>1</td> <td>PZ</td> </tr> <tr> <td>SL1045A0</td> <td>SILICONE ANTRACITE S57 80 ML</td> <td>1</td> <td>PZ</td> </tr> <tr> <td>VI1220A1</td> <td>VITE AUTOFILETTA NTE 4.2X11 TCS+ MARUTE</td> <td>2</td> <td>PZ</td> </tr> </tbody> </table>	Codice	Descrizione	Qtà	UM	GN1326A1	GUARNIZIONE RESISTENZA 71X19 G6.25	1	PZ	RS1261A0	RESISTENZA MOTORE BAKERLUX/CH EFLUX	1	PZ	SL1045A0	SILICONE ANTRACITE S57 80 ML	1	PZ	VI1220A1	VITE AUTOFILETTA NTE 4.2X11 TCS+ MARUTE	2	PZ
					Codice	Descrizione	Qtà	UM																	
					GN1326A1	GUARNIZIONE RESISTENZA 71X19 G6.25	1	PZ																	
					RS1261A0	RESISTENZA MOTORE BAKERLUX/CH EFLUX	1	PZ																	
SL1045A0	SILICONE ANTRACITE S57 80 ML	1			PZ																				
VI1220A1	VITE AUTOFILETTA NTE 4.2X11 TCS+ MARUTE	2	PZ																						
VM2147A0	SPUGNA ESD ROSA LISCIA 410X343X15 M	1	PZ																						

COMPONENTE			RICAMBIO																											
Codice	Descrizione	Immagine	Codice	Descrizione	Lista componenti																									
GN1326A	GUARNIZIONE RESISTENZA 71X19 G6.25		KRS1215A	KIT RESISTENZA FRENATA 147W	<table border="1"> <thead> <tr> <th>Codice</th> <th>Descrizione</th> <th>Qtà</th> <th>UM</th> </tr> </thead> <tbody> <tr> <td>GN1326A1</td> <td>GUARNIZIONE RESISTENZA 71X19 G6.25</td> <td>1</td> <td>PZ</td> </tr> <tr> <td>RS1215A1</td> <td>RESISTENZA FRENATA 147W 105V 1 SPIRA</td> <td>1</td> <td>PZ</td> </tr> <tr> <td>SL1045A0</td> <td>SILICONE ANTRACITE S57 80 ML</td> <td>1</td> <td>PZ</td> </tr> <tr> <td>VI1220A1</td> <td>VITE AUTOFILETTA NTE 4.2X11 TCS+ MARUTE</td> <td>2</td> <td>PZ</td> </tr> </tbody> </table>	Codice	Descrizione	Qtà	UM	GN1326A1	GUARNIZIONE RESISTENZA 71X19 G6.25	1	PZ	RS1215A1	RESISTENZA FRENATA 147W 105V 1 SPIRA	1	PZ	SL1045A0	SILICONE ANTRACITE S57 80 ML	1	PZ	VI1220A1	VITE AUTOFILETTA NTE 4.2X11 TCS+ MARUTE	2	PZ					
			Codice	Descrizione	Qtà	UM																								
			GN1326A1	GUARNIZIONE RESISTENZA 71X19 G6.25	1	PZ																								
RS1215A1	RESISTENZA FRENATA 147W 105V 1 SPIRA	1	PZ																											
SL1045A0	SILICONE ANTRACITE S57 80 ML	1	PZ																											
VI1220A1	VITE AUTOFILETTA NTE 4.2X11 TCS+ MARUTE	2	PZ																											
KRS1095A	KIT RESISTENZA 1.2KW	<table border="1"> <thead> <tr> <th>Codice</th> <th>Descrizione</th> <th>Qtà</th> <th>UM</th> </tr> </thead> <tbody> <tr> <td>GN1326A1</td> <td>GUARNIZIONE RESISTENZA 71X19 G6.25</td> <td>1</td> <td>PZ</td> </tr> <tr> <td>IP1385A1</td> <td>IMB POL ANGOLARE 110X80X2000 D30</td> <td>0.500</td> <td>M</td> </tr> <tr> <td>RS1095A1</td> <td>RESISTENZA PIANA 1200W 230V</td> <td>1</td> <td>PZ</td> </tr> <tr> <td>SL1045A0</td> <td>SILICONE ANTRACITE S57 80 ML</td> <td>1</td> <td>PZ</td> </tr> <tr> <td>VI1220A1</td> <td>VITE AUTOFILETTA NTE 4.2X11 TCS+ MARUTE</td> <td>2</td> <td>PZ</td> </tr> <tr> <td>VM1059A1</td> <td>FILM TERMORETRA IBILE H800</td> <td>1.200</td> <td>M</td> </tr> </tbody> </table>	Codice	Descrizione	Qtà	UM	GN1326A1	GUARNIZIONE RESISTENZA 71X19 G6.25	1	PZ	IP1385A1	IMB POL ANGOLARE 110X80X2000 D30	0.500	M	RS1095A1	RESISTENZA PIANA 1200W 230V	1	PZ	SL1045A0	SILICONE ANTRACITE S57 80 ML	1	PZ	VI1220A1	VITE AUTOFILETTA NTE 4.2X11 TCS+ MARUTE	2	PZ	VM1059A1	FILM TERMORETRA IBILE H800	1.200	M
Codice	Descrizione	Qtà	UM																											
GN1326A1	GUARNIZIONE RESISTENZA 71X19 G6.25	1	PZ																											
IP1385A1	IMB POL ANGOLARE 110X80X2000 D30	0.500	M																											
RS1095A1	RESISTENZA PIANA 1200W 230V	1	PZ																											
SL1045A0	SILICONE ANTRACITE S57 80 ML	1	PZ																											
VI1220A1	VITE AUTOFILETTA NTE 4.2X11 TCS+ MARUTE	2	PZ																											
VM1059A1	FILM TERMORETRA IBILE H800	1.200	M																											
KRS1012A	KIT RESISTENZA 1365W 120V	<table border="1"> <thead> <tr> <th>Codice</th> <th>Descrizione</th> <th>Qtà</th> <th>UM</th> </tr> </thead> <tbody> <tr> <td>GN1326A1</td> <td>GUARNIZIONE RESISTENZA 71X19 G6.25</td> <td>1</td> <td>PZ</td> </tr> <tr> <td>RS1012A0</td> <td>RESISTENZA CIRCOLARE 1365W 120V</td> <td>1</td> <td>PZ</td> </tr> <tr> <td>VI1220A1</td> <td>VITE AUTOFILETTA NTE 4.2X11 TCS+ MARUTE</td> <td>5</td> <td>PZ</td> </tr> <tr> <td>VM1794A0</td> <td>FASCETTA 430X4.8 PA66 NERA</td> <td>2</td> <td>PZ</td> </tr> <tr> <td>VM2103A0</td> <td>PIASTRINA FERMAFASCE TTA</td> <td>2</td> <td>PZ</td> </tr> </tbody> </table>	Codice	Descrizione	Qtà	UM	GN1326A1	GUARNIZIONE RESISTENZA 71X19 G6.25	1	PZ	RS1012A0	RESISTENZA CIRCOLARE 1365W 120V	1	PZ	VI1220A1	VITE AUTOFILETTA NTE 4.2X11 TCS+ MARUTE	5	PZ	VM1794A0	FASCETTA 430X4.8 PA66 NERA	2	PZ	VM2103A0	PIASTRINA FERMAFASCE TTA	2	PZ				
Codice	Descrizione	Qtà	UM																											
GN1326A1	GUARNIZIONE RESISTENZA 71X19 G6.25	1	PZ																											
RS1012A0	RESISTENZA CIRCOLARE 1365W 120V	1	PZ																											
VI1220A1	VITE AUTOFILETTA NTE 4.2X11 TCS+ MARUTE	5	PZ																											
VM1794A0	FASCETTA 430X4.8 PA66 NERA	2	PZ																											
VM2103A0	PIASTRINA FERMAFASCE TTA	2	PZ																											



COMPONENTE			RICAMBIO																														
Codice	Descrizione	Immagine	Codice	Descrizione	Lista componenti																												
GN1326A	GUARNIZIONE RESISTENZA 71X19 G6.25		KRS1011A	KIT RESISTENZA ROBERTA/LISA	<table border="1"> <thead> <tr> <th>Codice</th> <th>Descrizione</th> <th>Qtà</th> <th>UM</th> </tr> </thead> <tbody> <tr> <td>GN1326A1</td> <td>GUARNIZIONE RESISTENZA 71X19 G6.25</td> <td>1</td> <td>PZ</td> </tr> <tr> <td>RS1011A0</td> <td>RESISTENZA CIRCOLARE 2560W 220-230</td> <td>1</td> <td>PZ</td> </tr> <tr> <td>SL1045A0</td> <td>SILICONE ANTRACITE S57 80 ML</td> <td>1</td> <td>PZ</td> </tr> <tr> <td>VI1220A1</td> <td>VITE AUTOFILETTA NTE 4.2X11 TCS+ MARUTE</td> <td>5</td> <td>PZ</td> </tr> <tr> <td>VM1794A0</td> <td>FASCETTA 430X4.8 PA66 NERA</td> <td>2</td> <td>PZ</td> </tr> <tr> <td>VM2103A0</td> <td>PIASTRINA FERMAFASCE TTA</td> <td>2</td> <td>PZ</td> </tr> </tbody> </table>	Codice	Descrizione	Qtà	UM	GN1326A1	GUARNIZIONE RESISTENZA 71X19 G6.25	1	PZ	RS1011A0	RESISTENZA CIRCOLARE 2560W 220-230	1	PZ	SL1045A0	SILICONE ANTRACITE S57 80 ML	1	PZ	VI1220A1	VITE AUTOFILETTA NTE 4.2X11 TCS+ MARUTE	5	PZ	VM1794A0	FASCETTA 430X4.8 PA66 NERA	2	PZ	VM2103A0	PIASTRINA FERMAFASCE TTA	2	PZ
			Codice	Descrizione	Qtà	UM																											
			GN1326A1	GUARNIZIONE RESISTENZA 71X19 G6.25	1	PZ																											
RS1011A0	RESISTENZA CIRCOLARE 2560W 220-230	1	PZ																														
SL1045A0	SILICONE ANTRACITE S57 80 ML	1	PZ																														
VI1220A1	VITE AUTOFILETTA NTE 4.2X11 TCS+ MARUTE	5	PZ																														
VM1794A0	FASCETTA 430X4.8 PA66 NERA	2	PZ																														
VM2103A0	PIASTRINA FERMAFASCE TTA	2	PZ																														
KRS0090A	KIT RESISTENZA 1.26KW	<table border="1"> <thead> <tr> <th>Codice</th> <th>Descrizione</th> <th>Qtà</th> <th>UM</th> </tr> </thead> <tbody> <tr> <td>GN1326A1</td> <td>GUARNIZIONE RESISTENZA 71X19 G6.25</td> <td>1</td> <td>PZ</td> </tr> <tr> <td>RS0090A0</td> <td>RESISTENZA CIRCOLARE 1260W 220-230</td> <td>1</td> <td>PZ</td> </tr> <tr> <td>VI1220A1</td> <td>VITE AUTOFILETTA NTE 4.2X11 TCS+ MARUTE</td> <td>3</td> <td>PZ</td> </tr> <tr> <td>VM1794A0</td> <td>FASCETTA 430X4.8 PA66 NERA</td> <td>2</td> <td>PZ</td> </tr> <tr> <td>VM2103A0</td> <td>PIASTRINA FERMAFASCE TTA</td> <td>2</td> <td>PZ</td> </tr> </tbody> </table>	Codice	Descrizione	Qtà	UM	GN1326A1	GUARNIZIONE RESISTENZA 71X19 G6.25	1	PZ	RS0090A0	RESISTENZA CIRCOLARE 1260W 220-230	1	PZ	VI1220A1	VITE AUTOFILETTA NTE 4.2X11 TCS+ MARUTE	3	PZ	VM1794A0	FASCETTA 430X4.8 PA66 NERA	2	PZ	VM2103A0	PIASTRINA FERMAFASCE TTA	2	PZ							
Codice	Descrizione	Qtà	UM																														
GN1326A1	GUARNIZIONE RESISTENZA 71X19 G6.25	1	PZ																														
RS0090A0	RESISTENZA CIRCOLARE 1260W 220-230	1	PZ																														
VI1220A1	VITE AUTOFILETTA NTE 4.2X11 TCS+ MARUTE	3	PZ																														
VM1794A0	FASCETTA 430X4.8 PA66 NERA	2	PZ																														
VM2103A0	PIASTRINA FERMAFASCE TTA	2	PZ																														
KRS0050A	KIT RESISTENZA 0.5KW	<table border="1"> <thead> <tr> <th>Codice</th> <th>Descrizione</th> <th>Qtà</th> <th>UM</th> </tr> </thead> <tbody> <tr> <td>GN1326A1</td> <td>GUARNIZIONE RESISTENZA 71X19 G6.25</td> <td>1</td> <td>PZ</td> </tr> <tr> <td>IP1075A1</td> <td>IMB POL 70X150X765 D=10 CON PRETAGLIO</td> <td>1</td> <td>PZ</td> </tr> <tr> <td>IP1080A1</td> <td>IMB POL 280X255X10 D=10</td> <td>1</td> <td>PZ</td> </tr> <tr> <td>RS0050A0</td> <td>RESISTENZA PIANA 500W 220-230V</td> <td>1</td> <td>PZ</td> </tr> <tr> <td>VI1220A1</td> <td>VITE AUTOFILETTA NTE 4.2X11 TCS+ MARUTE</td> <td>2</td> <td>PZ</td> </tr> </tbody> </table>	Codice	Descrizione	Qtà	UM	GN1326A1	GUARNIZIONE RESISTENZA 71X19 G6.25	1	PZ	IP1075A1	IMB POL 70X150X765 D=10 CON PRETAGLIO	1	PZ	IP1080A1	IMB POL 280X255X10 D=10	1	PZ	RS0050A0	RESISTENZA PIANA 500W 220-230V	1	PZ	VI1220A1	VITE AUTOFILETTA NTE 4.2X11 TCS+ MARUTE	2	PZ							
Codice	Descrizione	Qtà	UM																														
GN1326A1	GUARNIZIONE RESISTENZA 71X19 G6.25	1	PZ																														
IP1075A1	IMB POL 70X150X765 D=10 CON PRETAGLIO	1	PZ																														
IP1080A1	IMB POL 280X255X10 D=10	1	PZ																														
RS0050A0	RESISTENZA PIANA 500W 220-230V	1	PZ																														
VI1220A1	VITE AUTOFILETTA NTE 4.2X11 TCS+ MARUTE	2	PZ																														



COMPONENTE			RICAMBIO																										
Codice	Descrizione	Immagine	Codice	Descrizione	Lista componenti																								
GN1326A	GUARNIZIONE RESISTENZA 71X19 G6.25		KRS0011A	KIT RESISTENZA 1.465KW RS0011A	<table border="1"> <thead> <tr> <th>Codice</th> <th>Descrizione</th> <th>Qtà</th> <th>UM</th> </tr> </thead> <tbody> <tr> <td>GN1326A1</td> <td>GUARNIZIONE RESISTENZA 71X19 G6.25</td> <td>1</td> <td>PZ</td> </tr> <tr> <td>RS0011A0</td> <td>RESISTENZA CIRCOLARE 1465W 220-230</td> <td>1</td> <td>PZ</td> </tr> <tr> <td>VI1220A1</td> <td>VITE AUTOFILETTA NTE 4.2X11 TCS+ MARUTE</td> <td>3</td> <td>PZ</td> </tr> <tr> <td>VM1794A0</td> <td>FASCETTA 430X4.8 PA66 NERA</td> <td>2</td> <td>PZ</td> </tr> <tr> <td>VM2103A0</td> <td>PIASTRINA FERMAFASCE TTA</td> <td>2</td> <td>PZ</td> </tr> </tbody> </table>	Codice	Descrizione	Qtà	UM	GN1326A1	GUARNIZIONE RESISTENZA 71X19 G6.25	1	PZ	RS0011A0	RESISTENZA CIRCOLARE 1465W 220-230	1	PZ	VI1220A1	VITE AUTOFILETTA NTE 4.2X11 TCS+ MARUTE	3	PZ	VM1794A0	FASCETTA 430X4.8 PA66 NERA	2	PZ	VM2103A0	PIASTRINA FERMAFASCE TTA	2	PZ
			Codice	Descrizione	Qtà	UM																							
			GN1326A1	GUARNIZIONE RESISTENZA 71X19 G6.25	1	PZ																							
RS0011A0	RESISTENZA CIRCOLARE 1465W 220-230	1	PZ																										
VI1220A1	VITE AUTOFILETTA NTE 4.2X11 TCS+ MARUTE	3	PZ																										
VM1794A0	FASCETTA 430X4.8 PA66 NERA	2	PZ																										
VM2103A0	PIASTRINA FERMAFASCE TTA	2	PZ																										
KRS0010A	KIT RESISTENZA RS0010A	<table border="1"> <thead> <tr> <th>Codice</th> <th>Descrizione</th> <th>Qtà</th> <th>UM</th> </tr> </thead> <tbody> <tr> <td>GN1326A1</td> <td>GUARNIZIONE RESISTENZA 71X19 G6.25</td> <td>1</td> <td>PZ</td> </tr> <tr> <td>IP1075A1</td> <td>IMB POL 70X150X765 D=10 CON PRETAGLIO</td> <td>1</td> <td>PZ</td> </tr> <tr> <td>IP1080A1</td> <td>IMB POL 280X255X10 D=10</td> <td>5</td> <td>PZ</td> </tr> <tr> <td>RS0010A0</td> <td>RESISTENZA CIRCOLARE 2560W 220-230</td> <td>1</td> <td>PZ</td> </tr> <tr> <td>VI1220A1</td> <td>VITE AUTOFILETTA NTE 4.2X11 TCS+ MARUTE</td> <td>3</td> <td>PZ</td> </tr> </tbody> </table>	Codice	Descrizione	Qtà	UM	GN1326A1	GUARNIZIONE RESISTENZA 71X19 G6.25	1	PZ	IP1075A1	IMB POL 70X150X765 D=10 CON PRETAGLIO	1	PZ	IP1080A1	IMB POL 280X255X10 D=10	5	PZ	RS0010A0	RESISTENZA CIRCOLARE 2560W 220-230	1	PZ	VI1220A1	VITE AUTOFILETTA NTE 4.2X11 TCS+ MARUTE	3	PZ			
Codice	Descrizione	Qtà	UM																										
GN1326A1	GUARNIZIONE RESISTENZA 71X19 G6.25	1	PZ																										
IP1075A1	IMB POL 70X150X765 D=10 CON PRETAGLIO	1	PZ																										
IP1080A1	IMB POL 280X255X10 D=10	5	PZ																										
RS0010A0	RESISTENZA CIRCOLARE 2560W 220-230	1	PZ																										
VI1220A1	VITE AUTOFILETTA NTE 4.2X11 TCS+ MARUTE	3	PZ																										
KG1326A	KIT 5 PZ GUARNIZIONE RESISTENZA	<table border="1"> <thead> <tr> <th>Codice</th> <th>Descrizione</th> <th>Qtà</th> <th>UM</th> </tr> </thead> <tbody> <tr> <td>GN1326A1</td> <td>GUARNIZIONE RESISTENZA 71X19 G6.25</td> <td>5</td> <td>PZ</td> </tr> <tr> <td>VM1224A0</td> <td>TUBOLARE TERMORETR 65MY 220MM 2 COLORI</td> <td>0.200</td> <td>M</td> </tr> </tbody> </table>	Codice	Descrizione	Qtà	UM	GN1326A1	GUARNIZIONE RESISTENZA 71X19 G6.25	5	PZ	VM1224A0	TUBOLARE TERMORETR 65MY 220MM 2 COLORI	0.200	M															
Codice	Descrizione	Qtà	UM																										
GN1326A1	GUARNIZIONE RESISTENZA 71X19 G6.25	5	PZ																										
VM1224A0	TUBOLARE TERMORETR 65MY 220MM 2 COLORI	0.200	M																										

COMPONENTE			RICAMBIO																																		
Codice	Descrizione	Immagine	Codice	Descrizione	Lista componenti																																
EL1251A	ELETTROVALVOLA H2O 1 VIA RID. MARRONE		KEL1251A	KIT ELETTROVALVOLA 1 VIA MAR. JG D8-D1	<table border="1"> <thead> <tr> <th>Codice</th> <th>Descrizione</th> <th>Qtà</th> <th>UM</th> </tr> </thead> <tbody> <tr> <td>EL1251A0</td> <td>ELETTROVALV OLA H2O 1 VIA RID. MARRON</td> <td>1</td> <td>PZ</td> </tr> <tr> <td>VM1224A0</td> <td>TUBOLARE TERMORETR 65MY 220MM 2 COLORI</td> <td>0.250</td> <td>M</td> </tr> </tbody> </table>	Codice	Descrizione	Qtà	UM	EL1251A0	ELETTROVALV OLA H2O 1 VIA RID. MARRON	1	PZ	VM1224A0	TUBOLARE TERMORETR 65MY 220MM 2 COLORI	0.250	M																				
Codice	Descrizione	Qtà	UM																																		
EL1251A0	ELETTROVALV OLA H2O 1 VIA RID. MARRON	1	PZ																																		
VM1224A0	TUBOLARE TERMORETR 65MY 220MM 2 COLORI	0.250	M																																		
RS1002A	RES. CIRCOLARE 6750W 230V 6 SPIRE		KRS1002A	KIT RESISTENZA 6750W 230V 6 SPIRE	<table border="1"> <thead> <tr> <th>Codice</th> <th>Descrizione</th> <th>Qtà</th> <th>UM</th> </tr> </thead> <tbody> <tr> <td>GN1086A0</td> <td>GUARNIZIONE RESISTENZA 141X22 G8.5</td> <td>1</td> <td>PZ</td> </tr> <tr> <td>RS1002A1</td> <td>RES. CIRCOLARE 6750W 230V 6 SPIRE</td> <td>1</td> <td>PZ</td> </tr> <tr> <td>SL1045A0</td> <td>SILICONE ANTRACITE S57 80 ML</td> <td>1</td> <td>PZ</td> </tr> <tr> <td>VI1220A1</td> <td>VITE AUTOFILETTA NTE 4.2X11 TCS+ MARUTE</td> <td>5</td> <td>PZ</td> </tr> <tr> <td>VM1794A0</td> <td>FASCETTA 430X4.8 PA66 NERA</td> <td>2</td> <td>PZ</td> </tr> <tr> <td>VM2103A0</td> <td>PIASTRINA FERMAFASCE TTA</td> <td>2</td> <td>PZ</td> </tr> </tbody> </table>	Codice	Descrizione	Qtà	UM	GN1086A0	GUARNIZIONE RESISTENZA 141X22 G8.5	1	PZ	RS1002A1	RES. CIRCOLARE 6750W 230V 6 SPIRE	1	PZ	SL1045A0	SILICONE ANTRACITE S57 80 ML	1	PZ	VI1220A1	VITE AUTOFILETTA NTE 4.2X11 TCS+ MARUTE	5	PZ	VM1794A0	FASCETTA 430X4.8 PA66 NERA	2	PZ	VM2103A0	PIASTRINA FERMAFASCE TTA	2	PZ				
Codice	Descrizione	Qtà	UM																																		
GN1086A0	GUARNIZIONE RESISTENZA 141X22 G8.5	1	PZ																																		
RS1002A1	RES. CIRCOLARE 6750W 230V 6 SPIRE	1	PZ																																		
SL1045A0	SILICONE ANTRACITE S57 80 ML	1	PZ																																		
VI1220A1	VITE AUTOFILETTA NTE 4.2X11 TCS+ MARUTE	5	PZ																																		
VM1794A0	FASCETTA 430X4.8 PA66 NERA	2	PZ																																		
VM2103A0	PIASTRINA FERMAFASCE TTA	2	PZ																																		
MT1012A	MOTORE SIMMETRICO 330W 230V ALBERO D12		KMT1012A	KIT MOTORE 330W 230V ALBERO D12	<table border="1"> <thead> <tr> <th>Codice</th> <th>Descrizione</th> <th>Qtà</th> <th>UM</th> </tr> </thead> <tbody> <tr> <td>0H4305A1</td> <td>DISCO TENUTA ALBERO MOTORE INOX STP</td> <td>1</td> <td>PZ</td> </tr> <tr> <td>GN1140A2</td> <td>GUARNIZIONE PORTAMOTO RE STAMPAT</td> <td>1</td> <td>PZ</td> </tr> <tr> <td>GN1140A3</td> <td>GUARNIZIONE PORTAMOTO RE STAMPAT</td> <td>1</td> <td>PZ</td> </tr> <tr> <td>MT1012A0</td> <td>MOTORE SIMMETRICO 330W 230V ALBERO D12</td> <td>1</td> <td>PZ</td> </tr> <tr> <td>VE1550A0</td> <td>MAGNETE NEODIMIO 5X3 MM</td> <td>1</td> <td>PZ</td> </tr> <tr> <td>VI1077A1</td> <td>VITE M6X12 TE INOX</td> <td>1</td> <td>PZ</td> </tr> <tr> <td>VI1521A0</td> <td>RONDELLA PIANA 6X12X1 INOX</td> <td>1</td> <td>PZ</td> </tr> </tbody> </table>	Codice	Descrizione	Qtà	UM	0H4305A1	DISCO TENUTA ALBERO MOTORE INOX STP	1	PZ	GN1140A2	GUARNIZIONE PORTAMOTO RE STAMPAT	1	PZ	GN1140A3	GUARNIZIONE PORTAMOTO RE STAMPAT	1	PZ	MT1012A0	MOTORE SIMMETRICO 330W 230V ALBERO D12	1	PZ	VE1550A0	MAGNETE NEODIMIO 5X3 MM	1	PZ	VI1077A1	VITE M6X12 TE INOX	1	PZ	VI1521A0	RONDELLA PIANA 6X12X1 INOX	1	PZ
Codice	Descrizione	Qtà	UM																																		
0H4305A1	DISCO TENUTA ALBERO MOTORE INOX STP	1	PZ																																		
GN1140A2	GUARNIZIONE PORTAMOTO RE STAMPAT	1	PZ																																		
GN1140A3	GUARNIZIONE PORTAMOTO RE STAMPAT	1	PZ																																		
MT1012A0	MOTORE SIMMETRICO 330W 230V ALBERO D12	1	PZ																																		
VE1550A0	MAGNETE NEODIMIO 5X3 MM	1	PZ																																		
VI1077A1	VITE M6X12 TE INOX	1	PZ																																		
VI1521A0	RONDELLA PIANA 6X12X1 INOX	1	PZ																																		

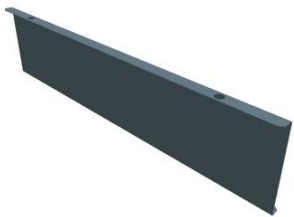
COMPONENTE			RICAMBIO																										
Codice	Descrizione	Immagine	Codice	Descrizione	Lista componenti																								
MT1012A	MOTORE SIMMETRICO 330W 230V ALBERO D12		KMT1012A	KIT MOTORE 330W 230V ALBERO D12	<table border="1"> <thead> <tr> <th>Codice</th> <th>Descrizione</th> <th>Qtà</th> <th>UM</th> </tr> </thead> <tbody> <tr> <td>VI1966A0</td> <td>VITE M4X14 TSP+ ZN</td> <td>1</td> <td>PZ</td> </tr> <tr> <td>VM1635A0</td> <td>DISCO SUPPORTO MAGNETE</td> <td>1</td> <td>PZ</td> </tr> <tr> <td>VM1794A0</td> <td>FASCETTA 430X4.8 PA66 NERA</td> <td>4</td> <td>PZ</td> </tr> <tr> <td>VM2103A0</td> <td>PIASTRINA FERMAFASCE TTA</td> <td>4</td> <td>PZ</td> </tr> </tbody> </table>	Codice	Descrizione	Qtà	UM	VI1966A0	VITE M4X14 TSP+ ZN	1	PZ	VM1635A0	DISCO SUPPORTO MAGNETE	1	PZ	VM1794A0	FASCETTA 430X4.8 PA66 NERA	4	PZ	VM2103A0	PIASTRINA FERMAFASCE TTA	4	PZ				
Codice	Descrizione	Qtà	UM																										
VI1966A0	VITE M4X14 TSP+ ZN	1	PZ																										
VM1635A0	DISCO SUPPORTO MAGNETE	1	PZ																										
VM1794A0	FASCETTA 430X4.8 PA66 NERA	4	PZ																										
VM2103A0	PIASTRINA FERMAFASCE TTA	4	PZ																										
GN1140A	GUARNIZIONE PORTAMOTORE STAMPATO		KGN1140A	KIT 5 PZ. GUARNIZIONE PORTAMOTORE	<table border="1"> <thead> <tr> <th>Codice</th> <th>Descrizione</th> <th>Qtà</th> <th>UM</th> </tr> </thead> <tbody> <tr> <td>GN1140A2</td> <td>GUARNIZIONE PORTAMOTO RE STAMPAT</td> <td>5</td> <td>PZ</td> </tr> <tr> <td>GN1140A3</td> <td>GUARNIZIONE PORTAMOTO RE STAMPAT</td> <td>5</td> <td>PZ</td> </tr> <tr> <td>VM1224A0</td> <td>TUBOLARE TERMORETR 65MY 220MM 2 COLORI</td> <td>0.200</td> <td>M</td> </tr> </tbody> </table>	Codice	Descrizione	Qtà	UM	GN1140A2	GUARNIZIONE PORTAMOTO RE STAMPAT	5	PZ	GN1140A3	GUARNIZIONE PORTAMOTO RE STAMPAT	5	PZ	VM1224A0	TUBOLARE TERMORETR 65MY 220MM 2 COLORI	0.200	M								
Codice	Descrizione	Qtà	UM																										
GN1140A2	GUARNIZIONE PORTAMOTO RE STAMPAT	5	PZ																										
GN1140A3	GUARNIZIONE PORTAMOTO RE STAMPAT	5	PZ																										
VM1224A0	TUBOLARE TERMORETR 65MY 220MM 2 COLORI	0.200	M																										
OH4305A	DISCO TENUTA ALBERO MOTORE INOX STP		KOH4305A	KIT DISCO TENUTA ALBERO MOTORE	<table border="1"> <thead> <tr> <th>Codice</th> <th>Descrizione</th> <th>Qtà</th> <th>UM</th> </tr> </thead> <tbody> <tr> <td>OH4305A1</td> <td>DISCO TENUTA ALBERO MOTORE INOX STP</td> <td>1</td> <td>PZ</td> </tr> <tr> <td>GN1140A2</td> <td>GUARNIZIONE PORTAMOTO RE STAMPAT</td> <td>1</td> <td>PZ</td> </tr> <tr> <td>GN1140A3</td> <td>GUARNIZIONE PORTAMOTO RE STAMPAT</td> <td>1</td> <td>PZ</td> </tr> <tr> <td>SL1045A0</td> <td>SILICONE ANTRACITE S57 80 ML</td> <td>1</td> <td>PZ</td> </tr> <tr> <td>VI1220A1</td> <td>VITE AUTOFISETTA NTE 4.2X11 TCS+ MARUTE</td> <td>3</td> <td>PZ</td> </tr> </tbody> </table>	Codice	Descrizione	Qtà	UM	OH4305A1	DISCO TENUTA ALBERO MOTORE INOX STP	1	PZ	GN1140A2	GUARNIZIONE PORTAMOTO RE STAMPAT	1	PZ	GN1140A3	GUARNIZIONE PORTAMOTO RE STAMPAT	1	PZ	SL1045A0	SILICONE ANTRACITE S57 80 ML	1	PZ	VI1220A1	VITE AUTOFISETTA NTE 4.2X11 TCS+ MARUTE	3	PZ
Codice	Descrizione	Qtà	UM																										
OH4305A1	DISCO TENUTA ALBERO MOTORE INOX STP	1	PZ																										
GN1140A2	GUARNIZIONE PORTAMOTO RE STAMPAT	1	PZ																										
GN1140A3	GUARNIZIONE PORTAMOTO RE STAMPAT	1	PZ																										
SL1045A0	SILICONE ANTRACITE S57 80 ML	1	PZ																										
VI1220A1	VITE AUTOFISETTA NTE 4.2X11 TCS+ MARUTE	3	PZ																										
VN1181A	VENTOLA D196 H81 39 PALE VITE M6		KVN1181A	KIT VENTOLA D196 H81 39 PALE VITE M	<table border="1"> <thead> <tr> <th>Codice</th> <th>Descrizione</th> <th>Qtà</th> <th>UM</th> </tr> </thead> <tbody> <tr> <td>VI1077A1</td> <td>VITE M6X12 TE INOX</td> <td>1</td> <td>PZ</td> </tr> <tr> <td>VI1521A0</td> <td>RONDELLA PIANA 6X12X1 INOX</td> <td>1</td> <td>PZ</td> </tr> <tr> <td>VN1181A0</td> <td>VENTOLA D196 H81 39 PALE VITE M6</td> <td>1</td> <td>PZ</td> </tr> <tr> <td>VN1181A0</td> <td>VENTOLA D196 H81 39 PALE VITE M6</td> <td>1</td> <td>PZ</td> </tr> </tbody> </table>	Codice	Descrizione	Qtà	UM	VI1077A1	VITE M6X12 TE INOX	1	PZ	VI1521A0	RONDELLA PIANA 6X12X1 INOX	1	PZ	VN1181A0	VENTOLA D196 H81 39 PALE VITE M6	1	PZ	VN1181A0	VENTOLA D196 H81 39 PALE VITE M6	1	PZ				
Codice	Descrizione	Qtà	UM																										
VI1077A1	VITE M6X12 TE INOX	1	PZ																										
VI1521A0	RONDELLA PIANA 6X12X1 INOX	1	PZ																										
VN1181A0	VENTOLA D196 H81 39 PALE VITE M6	1	PZ																										
VN1181A0	VENTOLA D196 H81 39 PALE VITE M6	1	PZ																										

COMPONENTE			RICAMBIO																										
<i>Codice</i>	<i>Descrizione</i>	<i>Immagine</i>	<i>Codice</i>	<i>Descrizione</i>	<i>Lista componenti</i>																								
TB1515A	TUBO EST.UMIDITA' + RC1165A0		TB1515A1	TUBO EST.UMIDITA' + RC1165A0																									
0H6334A	STAFFA SOSTEGNO MUFFOLA BL CL		0H6334A0	STAFFA SOSTEGNO MUFFOLA BL CL																									
RS1261A	RESISTENZA MOTORE BAKERLUX\CHEFLU		KRS1261A	KIT RESISTENZA FRENATA 122W	<table border="1"> <thead> <tr> <th>Codice</th> <th>Descrizione</th> <th>Q.tà</th> <th>UM</th> </tr> </thead> <tbody> <tr> <td>GN1326A1</td> <td>GUARNIZIONE RESISTENZA 71X19 G6,25</td> <td>1</td> <td>PZ</td> </tr> <tr> <td>RS1261A0</td> <td>RESISTENZA MOTORE BAKERLUX\CH EFLUX</td> <td>1</td> <td>PZ</td> </tr> <tr> <td>SL1045A0</td> <td>SILICONE ANTRACITE S57 80 ML</td> <td>1</td> <td>PZ</td> </tr> <tr> <td>VI1220A1</td> <td>VITE AUTOFILETTA NTE 4.2X11 TCS+ MARUTE</td> <td>2</td> <td>PZ</td> </tr> <tr> <td>VM2147A0</td> <td>SPUGNA ESD ROSA LISCIA 410X343X15 M</td> <td>1</td> <td>PZ</td> </tr> </tbody> </table>	Codice	Descrizione	Q.tà	UM	GN1326A1	GUARNIZIONE RESISTENZA 71X19 G6,25	1	PZ	RS1261A0	RESISTENZA MOTORE BAKERLUX\CH EFLUX	1	PZ	SL1045A0	SILICONE ANTRACITE S57 80 ML	1	PZ	VI1220A1	VITE AUTOFILETTA NTE 4.2X11 TCS+ MARUTE	2	PZ	VM2147A0	SPUGNA ESD ROSA LISCIA 410X343X15 M	1	PZ
Codice	Descrizione	Q.tà	UM																										
GN1326A1	GUARNIZIONE RESISTENZA 71X19 G6,25	1	PZ																										
RS1261A0	RESISTENZA MOTORE BAKERLUX\CH EFLUX	1	PZ																										
SL1045A0	SILICONE ANTRACITE S57 80 ML	1	PZ																										
VI1220A1	VITE AUTOFILETTA NTE 4.2X11 TCS+ MARUTE	2	PZ																										
VM2147A0	SPUGNA ESD ROSA LISCIA 410X343X15 M	1	PZ																										
0G1490A	CARTER ARIA XVC305E XV393		0G1490A0	CARTER ARIA XVC305E XV393																									

COMPONENTE			RICAMBIO																														
Codice	Descrizione	Immagine	Codice	Descrizione	Lista componenti																												
0G1493A	DISTANZIALE CARTER XVC305E/705E		0G1493A0	DISTANZIALE CARTER XVC305E/705E																													
GRL1221A	SUPPORTO LAT. SX 5 GN1/1 XVC305/315		KGRL1220A	KIT SUPPORTI LATERALI 5TG GN1/1 XV	<table border="1"> <thead> <tr> <th>Codice</th> <th>Descrizione</th> <th>Qtà</th> <th>UM</th> </tr> </thead> <tbody> <tr> <td>0H4420A0</td> <td>PIASTRINA SUPPORTO SONDA AL CUORE H35</td> <td>1</td> <td>PZ</td> </tr> <tr> <td>0H6583A1</td> <td>PROFILO PIANO PER SUPP 0H4370A 0H4371A</td> <td>2</td> <td>PZ</td> </tr> <tr> <td>0H6583A2</td> <td>PROFILO PIANO PER SUPP 0H4370A 0H4371A</td> <td>2</td> <td>PZ</td> </tr> <tr> <td>0H6584A1</td> <td>PROFILO PIANO PER SUPP 0H4375A 0H4376A</td> <td>2</td> <td>PZ</td> </tr> <tr> <td>0H6584A2</td> <td>PROFILO PIANO PER SUPP 0H4375A 0H4376A</td> <td>2</td> <td>PZ</td> </tr> <tr> <td>0H7797A0</td> <td>PROFILO GUIDA TEGLIE GN1/1 L287 ASOLATO</td> <td>10</td> <td>PZ</td> </tr> </tbody> </table>	Codice	Descrizione	Qtà	UM	0H4420A0	PIASTRINA SUPPORTO SONDA AL CUORE H35	1	PZ	0H6583A1	PROFILO PIANO PER SUPP 0H4370A 0H4371A	2	PZ	0H6583A2	PROFILO PIANO PER SUPP 0H4370A 0H4371A	2	PZ	0H6584A1	PROFILO PIANO PER SUPP 0H4375A 0H4376A	2	PZ	0H6584A2	PROFILO PIANO PER SUPP 0H4375A 0H4376A	2	PZ	0H7797A0	PROFILO GUIDA TEGLIE GN1/1 L287 ASOLATO	10	PZ
Codice	Descrizione	Qtà	UM																														
0H4420A0	PIASTRINA SUPPORTO SONDA AL CUORE H35	1	PZ																														
0H6583A1	PROFILO PIANO PER SUPP 0H4370A 0H4371A	2	PZ																														
0H6583A2	PROFILO PIANO PER SUPP 0H4370A 0H4371A	2	PZ																														
0H6584A1	PROFILO PIANO PER SUPP 0H4375A 0H4376A	2	PZ																														
0H6584A2	PROFILO PIANO PER SUPP 0H4375A 0H4376A	2	PZ																														
0H7797A0	PROFILO GUIDA TEGLIE GN1/1 L287 ASOLATO	10	PZ																														
GRL1220A	SUPPORTO LAT. DX 5 GN1/1 XVC305/315		KGRL1220A	KIT SUPPORTI LATERALI 5TG GN1/1 XV	<table border="1"> <thead> <tr> <th>Codice</th> <th>Descrizione</th> <th>Qtà</th> <th>UM</th> </tr> </thead> <tbody> <tr> <td>0H4420A0</td> <td>PIASTRINA SUPPORTO SONDA AL CUORE H35</td> <td>1</td> <td>PZ</td> </tr> <tr> <td>0H6583A1</td> <td>PROFILO PIANO PER SUPP 0H4370A 0H4371A</td> <td>2</td> <td>PZ</td> </tr> <tr> <td>0H6583A2</td> <td>PROFILO PIANO PER SUPP 0H4370A 0H4371A</td> <td>2</td> <td>PZ</td> </tr> <tr> <td>0H6584A1</td> <td>PROFILO PIANO PER SUPP 0H4375A 0H4376A</td> <td>2</td> <td>PZ</td> </tr> </tbody> </table>	Codice	Descrizione	Qtà	UM	0H4420A0	PIASTRINA SUPPORTO SONDA AL CUORE H35	1	PZ	0H6583A1	PROFILO PIANO PER SUPP 0H4370A 0H4371A	2	PZ	0H6583A2	PROFILO PIANO PER SUPP 0H4370A 0H4371A	2	PZ	0H6584A1	PROFILO PIANO PER SUPP 0H4375A 0H4376A	2	PZ								
Codice	Descrizione	Qtà	UM																														
0H4420A0	PIASTRINA SUPPORTO SONDA AL CUORE H35	1	PZ																														
0H6583A1	PROFILO PIANO PER SUPP 0H4370A 0H4371A	2	PZ																														
0H6583A2	PROFILO PIANO PER SUPP 0H4370A 0H4371A	2	PZ																														
0H6584A1	PROFILO PIANO PER SUPP 0H4375A 0H4376A	2	PZ																														

COMPONENTE			RICAMBIO																						
Codice	Descrizione	Immagine	Codice	Descrizione	Lista componenti																				
GRL1220A	SUPPORTO LAT. DX 5 GN1/1 XVC305/315		KGRL1220A	KIT SUPPORTI LATERALI 5TG GN1/1 XV	<table border="1"> <thead> <tr> <th>Codice</th> <th>Descrizione</th> <th>Qtà</th> <th>UM</th> </tr> </thead> <tbody> <tr> <td>0H6584A2</td> <td>PROFILO PIANO PER SUPP 0H4375A 0H4376A</td> <td>2</td> <td>PZ</td> </tr> <tr> <td>0H7797A0</td> <td>PROFILO GUIDA TEGLIE GN1/1 L287 ASOLATO</td> <td>10</td> <td>PZ</td> </tr> </tbody> </table>	Codice	Descrizione	Qtà	UM	0H6584A2	PROFILO PIANO PER SUPP 0H4375A 0H4376A	2	PZ	0H7797A0	PROFILO GUIDA TEGLIE GN1/1 L287 ASOLATO	10	PZ								
Codice	Descrizione	Qtà	UM																						
0H6584A2	PROFILO PIANO PER SUPP 0H4375A 0H4376A	2	PZ																						
0H7797A0	PROFILO GUIDA TEGLIE GN1/1 L287 ASOLATO	10	PZ																						
TB2320A	TUBO UMIDITA' XVC305E/705E Ø16X		TB2320A0	TUBO UMIDITA' XVC305E/705E Ø16X																					
GN1389C	GN1006A-GUARNIZI ONE PORTA SERIE 300		KG1662A	KIT GUARNIZIONE PORTA SERIE 300 TOP/LUX	<table border="1"> <thead> <tr> <th>Codice</th> <th>Descrizione</th> <th>Qtà</th> <th>UM</th> </tr> </thead> <tbody> <tr> <td>GN1626A0</td> <td>GUARNIZIONE FACCIATA DOPPIO LABBRO</td> <td>1.840</td> <td>M</td> </tr> <tr> <td>SL1025A0</td> <td>TUBETTO SIL.90ML DOW CORNING 734 CLEAR</td> <td>0.012</td> <td>PZ</td> </tr> <tr> <td>VM1224A0</td> <td>TUBOLARE TERMORETR 65MY 220MM 2 COLORI</td> <td>0.400</td> <td>M</td> </tr> <tr> <td>VM2277A0</td> <td>SPINA KIT GUARNIZIONE PORTA</td> <td>1</td> <td>PZ</td> </tr> </tbody> </table>	Codice	Descrizione	Qtà	UM	GN1626A0	GUARNIZIONE FACCIATA DOPPIO LABBRO	1.840	M	SL1025A0	TUBETTO SIL.90ML DOW CORNING 734 CLEAR	0.012	PZ	VM1224A0	TUBOLARE TERMORETR 65MY 220MM 2 COLORI	0.400	M	VM2277A0	SPINA KIT GUARNIZIONE PORTA	1	PZ
Codice	Descrizione	Qtà	UM																						
GN1626A0	GUARNIZIONE FACCIATA DOPPIO LABBRO	1.840	M																						
SL1025A0	TUBETTO SIL.90ML DOW CORNING 734 CLEAR	0.012	PZ																						
VM1224A0	TUBOLARE TERMORETR 65MY 220MM 2 COLORI	0.400	M																						
VM2277A0	SPINA KIT GUARNIZIONE PORTA	1	PZ																						

ASM2854A/0.D00 - Copertura esterna

FRONTE

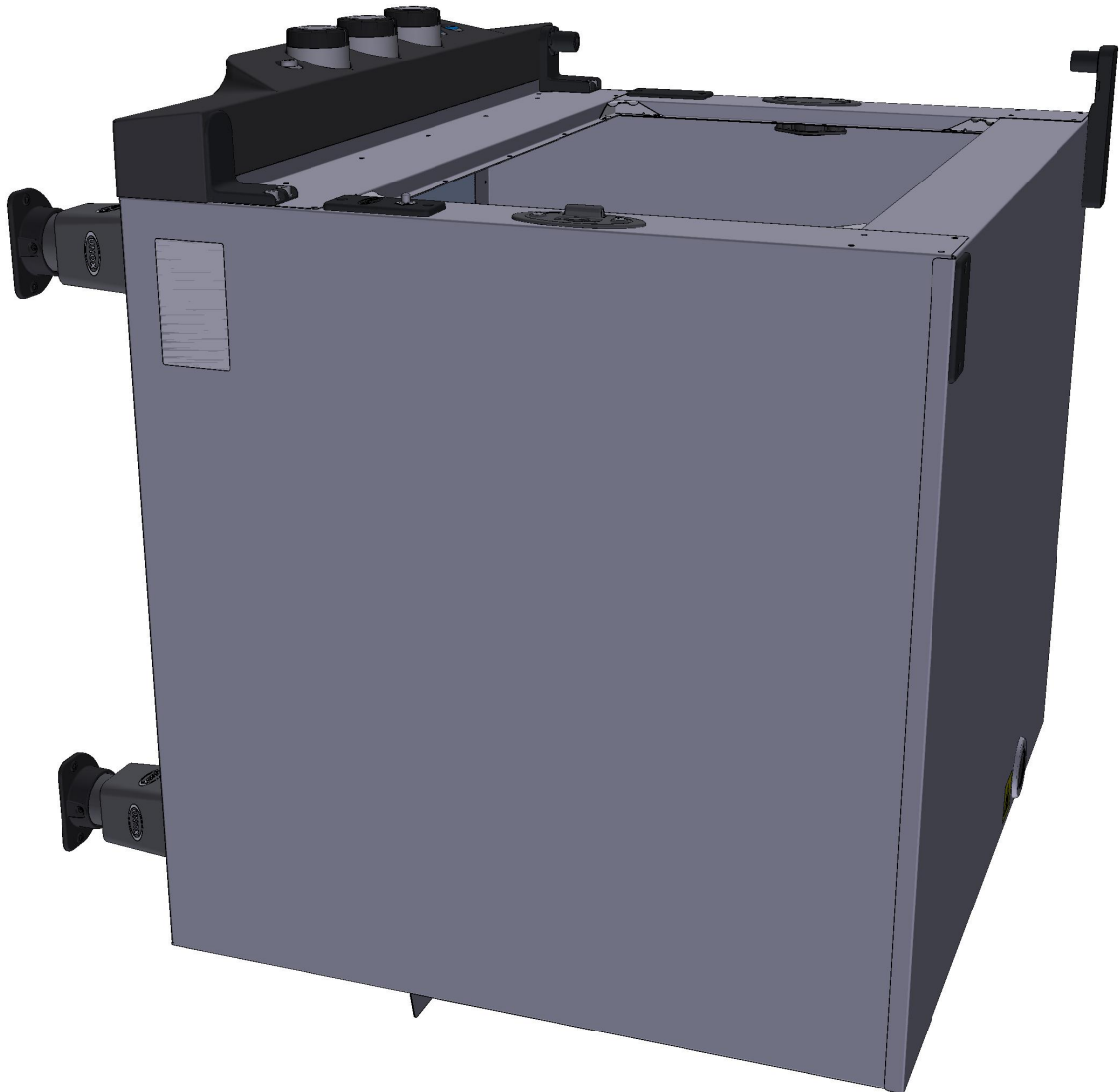

ASM2854A/0.D00 - Copertura esterna

RETRO

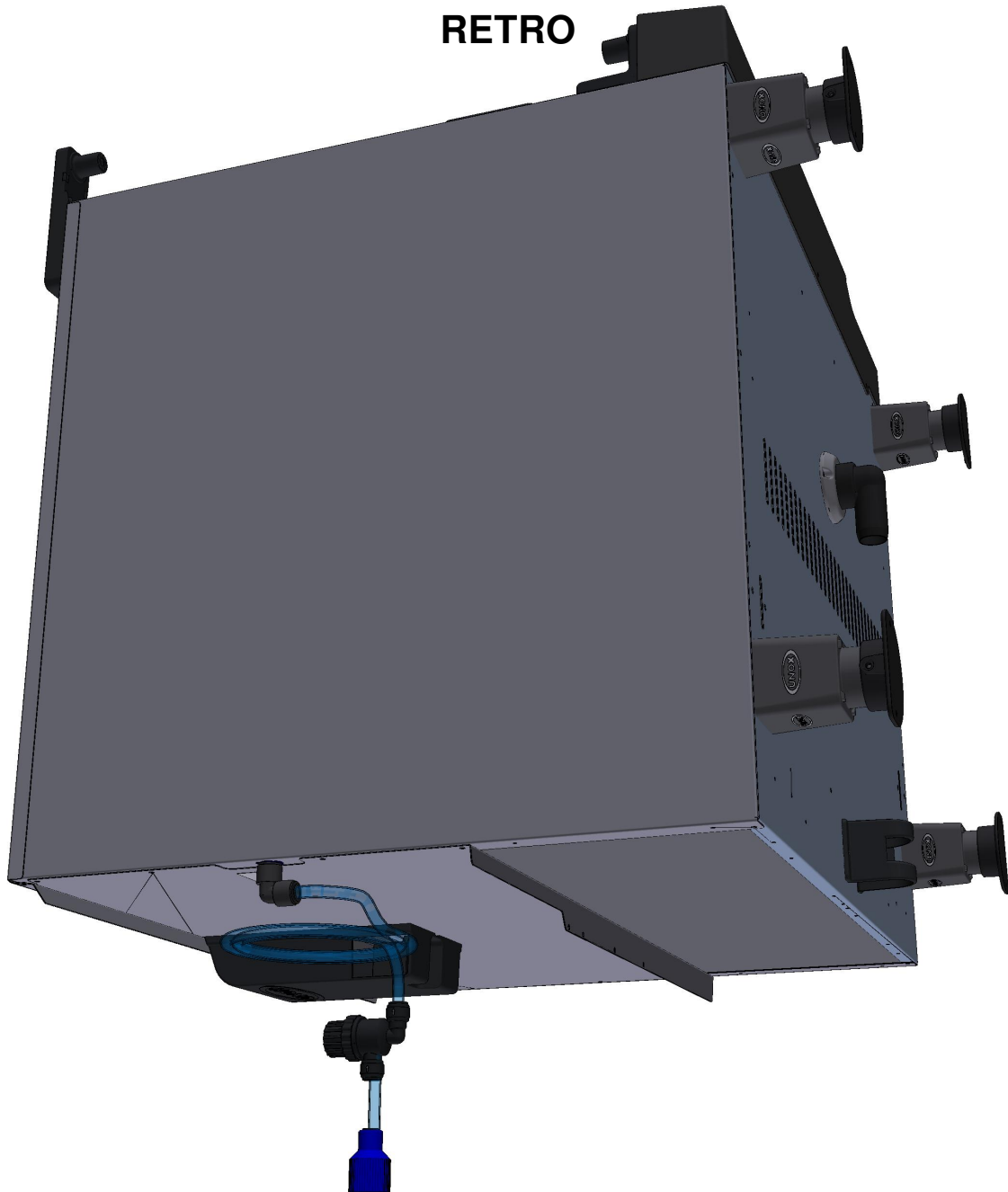

COMPONENTE			RICAMBIO																						
Codice	Descrizione	Immagine	Codice	Descrizione	Lista componenti																				
0H1450A	ANGOLO FACCIATA MUFFOLA INOX XB-XV-XG		0H1450A0	ANGOLO FACCIATA MUFFOLA INOX XB-XV-XG																					
VI1081A	VITE M6X25 TCEI INOX		KVI1081A	KIT 10 PZ VITE M6X25 TCEI INOX	<table border="1"> <thead> <tr> <th>Codice</th> <th>Descrizione</th> <th>Qtà</th> <th>UM</th> </tr> </thead> <tbody> <tr> <td>VI1081A0</td> <td>VITE M6X25 TCEI INOX</td> <td>10</td> <td>PZ</td> </tr> <tr> <td>VM1224A0</td> <td>TUBOLARE TERMORETR 65MY 220MM 2 COLORI</td> <td>0.200</td> <td>M</td> </tr> </tbody> </table>	Codice	Descrizione	Qtà	UM	VI1081A0	VITE M6X25 TCEI INOX	10	PZ	VM1224A0	TUBOLARE TERMORETR 65MY 220MM 2 COLORI	0.200	M								
Codice	Descrizione	Qtà	UM																						
VI1081A0	VITE M6X25 TCEI INOX	10	PZ																						
VM1224A0	TUBOLARE TERMORETR 65MY 220MM 2 COLORI	0.200	M																						
EL1195B	RACCORDO GOMITO Ø8F-Ø8M		KEL1195A	KIT 10 PZ RACCORDO GOMITO JG Ø8F-Ø8	<table border="1"> <thead> <tr> <th>Codice</th> <th>Descrizione</th> <th>Qtà</th> <th>UM</th> </tr> </thead> <tbody> <tr> <td>EL1195A0</td> <td>RACCORDO A GOMITO Ø8F-Ø8M</td> <td>10</td> <td>PZ</td> </tr> <tr> <td>VM1224A0</td> <td>TUBOLARE TERMORETR 65MY 220MM 2 COLORI</td> <td>0.200</td> <td>M</td> </tr> </tbody> </table>	Codice	Descrizione	Qtà	UM	EL1195A0	RACCORDO A GOMITO Ø8F-Ø8M	10	PZ	VM1224A0	TUBOLARE TERMORETR 65MY 220MM 2 COLORI	0.200	M								
Codice	Descrizione	Qtà	UM																						
EL1195A0	RACCORDO A GOMITO Ø8F-Ø8M	10	PZ																						
VM1224A0	TUBOLARE TERMORETR 65MY 220MM 2 COLORI	0.200	M																						
RC1002A	RACCORDO RIDUZIONE CODOLO 10M-8F		KRC1002A	KIT 10 PZ RIDUZIONE CODOLO JG Ø10M-Ø8F	<table border="1"> <thead> <tr> <th>Codice</th> <th>Descrizione</th> <th>Qtà</th> <th>UM</th> </tr> </thead> <tbody> <tr> <td>RC1002A0</td> <td>RACCORDO RIDUZIONE CODOLO 10M-8F</td> <td>10</td> <td>PZ</td> </tr> <tr> <td>VM1224A0</td> <td>TUBOLARE TERMORETR 65MY 220MM 2 COLORI</td> <td>0.200</td> <td>M</td> </tr> </tbody> </table>	Codice	Descrizione	Qtà	UM	RC1002A0	RACCORDO RIDUZIONE CODOLO 10M-8F	10	PZ	VM1224A0	TUBOLARE TERMORETR 65MY 220MM 2 COLORI	0.200	M								
Codice	Descrizione	Qtà	UM																						
RC1002A0	RACCORDO RIDUZIONE CODOLO 10M-8F	10	PZ																						
VM1224A0	TUBOLARE TERMORETR 65MY 220MM 2 COLORI	0.200	M																						
VL1026A	CURVA PER TUBO DI SCARICO		KVL1026A	KIT CURVA PER TUBO DI SCARICO	<table border="1"> <thead> <tr> <th>Codice</th> <th>Descrizione</th> <th>Qtà</th> <th>UM</th> </tr> </thead> <tbody> <tr> <td>GN1400A0</td> <td>GUARNIZIONE SIFONE</td> <td>1</td> <td>PZ</td> </tr> <tr> <td>VL1026A0</td> <td>CURVA PER TUBO DI SCARICO</td> <td>1</td> <td>PZ</td> </tr> <tr> <td>VM1224A0</td> <td>TUBOLARE TERMORETR 65MY 220MM 2 COLORI</td> <td>0.300</td> <td>M</td> </tr> <tr> <td>VM2039A0</td> <td>ANELLO FISSAGGIO CURVA DI SCARICO</td> <td>1</td> <td>PZ</td> </tr> </tbody> </table>	Codice	Descrizione	Qtà	UM	GN1400A0	GUARNIZIONE SIFONE	1	PZ	VL1026A0	CURVA PER TUBO DI SCARICO	1	PZ	VM1224A0	TUBOLARE TERMORETR 65MY 220MM 2 COLORI	0.300	M	VM2039A0	ANELLO FISSAGGIO CURVA DI SCARICO	1	PZ
Codice	Descrizione	Qtà	UM																						
GN1400A0	GUARNIZIONE SIFONE	1	PZ																						
VL1026A0	CURVA PER TUBO DI SCARICO	1	PZ																						
VM1224A0	TUBOLARE TERMORETR 65MY 220MM 2 COLORI	0.300	M																						
VM2039A0	ANELLO FISSAGGIO CURVA DI SCARICO	1	PZ																						



COMPONENTE			RICAMBIO																														
Codice	Descrizione	Immagine	Codice	Descrizione	Lista componenti																												
VM2039A	ANELLO FISSAGGIO CURVA DI SCARICO		KVL1026A	KIT CURVA PER TUBO DI SCARICO	<table border="1"> <thead> <tr> <th>Codice</th> <th>Descrizione</th> <th>Qtà</th> <th>UM</th> </tr> </thead> <tbody> <tr> <td>GN1400A0</td> <td>GUARNIZIONE SIFONE</td> <td>1</td> <td>PZ</td> </tr> <tr> <td>VL1026A0</td> <td>CURVA PER TUBO DI SCARICO</td> <td>1</td> <td>PZ</td> </tr> <tr> <td>VM1224A0</td> <td>TUBOLARE TERMORETR 65MY 220MM 2 COLORI</td> <td>0.300</td> <td>M</td> </tr> <tr> <td>VM2039A0</td> <td>ANELLO FISSAGGIO CURVA DI SCARICO</td> <td>1</td> <td>PZ</td> </tr> </tbody> </table>	Codice	Descrizione	Qtà	UM	GN1400A0	GUARNIZIONE SIFONE	1	PZ	VL1026A0	CURVA PER TUBO DI SCARICO	1	PZ	VM1224A0	TUBOLARE TERMORETR 65MY 220MM 2 COLORI	0.300	M	VM2039A0	ANELLO FISSAGGIO CURVA DI SCARICO	1	PZ								
Codice	Descrizione	Qtà	UM																														
GN1400A0	GUARNIZIONE SIFONE	1	PZ																														
VL1026A0	CURVA PER TUBO DI SCARICO	1	PZ																														
VM1224A0	TUBOLARE TERMORETR 65MY 220MM 2 COLORI	0.300	M																														
VM2039A0	ANELLO FISSAGGIO CURVA DI SCARICO	1	PZ																														
VM1190A	SCROCCO MANIGLIA DX CT BT		KVM1190A	KIT SCROCCO MANIGLIA DX CT BT	<table border="1"> <thead> <tr> <th>Codice</th> <th>Descrizione</th> <th>Qtà</th> <th>UM</th> </tr> </thead> <tbody> <tr> <td>VI0239A1</td> <td>VITE AUTOFIL. 4.2X25 TCB+ INOX</td> <td>2</td> <td>PZ</td> </tr> <tr> <td>VI1220A1</td> <td>VITE AUTOFILETTA NTE 4.2X11 TCS+ MARUTE</td> <td>2</td> <td>PZ</td> </tr> <tr> <td>VM1190A2</td> <td>SCROCCO MANIGLIA DX CT BT</td> <td>1</td> <td>PZ</td> </tr> <tr> <td>VM1192A1</td> <td>COPERCHIO POST. SCROCCO MANIGLIA CT BT</td> <td>1</td> <td>PZ</td> </tr> <tr> <td>VM1224A0</td> <td>TUBOLARE TERMORETR 65MY 220MM 2 COLORI</td> <td>0.200</td> <td>M</td> </tr> <tr> <td>VM1460A0</td> <td>COPERCHIO DX SCROCCO PORTA XBC/XVC</td> <td>1</td> <td>PZ</td> </tr> </tbody> </table>	Codice	Descrizione	Qtà	UM	VI0239A1	VITE AUTOFIL. 4.2X25 TCB+ INOX	2	PZ	VI1220A1	VITE AUTOFILETTA NTE 4.2X11 TCS+ MARUTE	2	PZ	VM1190A2	SCROCCO MANIGLIA DX CT BT	1	PZ	VM1192A1	COPERCHIO POST. SCROCCO MANIGLIA CT BT	1	PZ	VM1224A0	TUBOLARE TERMORETR 65MY 220MM 2 COLORI	0.200	M	VM1460A0	COPERCHIO DX SCROCCO PORTA XBC/XVC	1	PZ
Codice	Descrizione	Qtà	UM																														
VI0239A1	VITE AUTOFIL. 4.2X25 TCB+ INOX	2	PZ																														
VI1220A1	VITE AUTOFILETTA NTE 4.2X11 TCS+ MARUTE	2	PZ																														
VM1190A2	SCROCCO MANIGLIA DX CT BT	1	PZ																														
VM1192A1	COPERCHIO POST. SCROCCO MANIGLIA CT BT	1	PZ																														
VM1224A0	TUBOLARE TERMORETR 65MY 220MM 2 COLORI	0.200	M																														
VM1460A0	COPERCHIO DX SCROCCO PORTA XBC/XVC	1	PZ																														
VM1240A	TAPPO NYLON SUPPORTO CONTROSTAFFA		KVM1240A	KIT TAPPO SUPPORTO CONTROSTAFFA 4P	<table border="1"> <thead> <tr> <th>Codice</th> <th>Descrizione</th> <th>Qtà</th> <th>UM</th> </tr> </thead> <tbody> <tr> <td>VM1224A0</td> <td>TUBOLARE TERMORETR 65MY 220MM 2 COLORI</td> <td>0.200</td> <td>M</td> </tr> <tr> <td>VM1240A0</td> <td>TAPPO NYLON SUPPORTO CONTROSTAFFA</td> <td>4</td> <td>PZ</td> </tr> </tbody> </table>	Codice	Descrizione	Qtà	UM	VM1224A0	TUBOLARE TERMORETR 65MY 220MM 2 COLORI	0.200	M	VM1240A0	TAPPO NYLON SUPPORTO CONTROSTAFFA	4	PZ																
Codice	Descrizione	Qtà	UM																														
VM1224A0	TUBOLARE TERMORETR 65MY 220MM 2 COLORI	0.200	M																														
VM1240A0	TAPPO NYLON SUPPORTO CONTROSTAFFA	4	PZ																														

COMPONENTE			RICAMBIO																														
Codice	Descrizione	Immagine	Codice	Descrizione	Lista componenti																												
VM1195A	PIASTRINA COPRIFORI XVC204/304/504/704		VM1195A0	PIASTRINA COPRIFORI XVC204/304/504/704																													
0H3790A	LAMIERA TENUTA CAMINO		0H3790A0	LAMIERA TENUTA CAMINO																													
GN1275A	GUARNIZIONE CAMINO SILICONE NERO XVC		KG1275A	KIT GUARNIZIONE CAMINO SILICONE NERO 4PZ	<table border="1"> <thead> <tr> <th>Codice</th> <th>Descrizione</th> <th>Qtà</th> <th>UM</th> </tr> </thead> <tbody> <tr> <td>GN1275A0</td> <td>GUARNIZIONE CAMINO SILICONE NERO XVC</td> <td>4</td> <td>PZ</td> </tr> <tr> <td>VM1224A0</td> <td>TUBOLARE TERMORETR 65MY 220MM 2 COLORI</td> <td>0.200</td> <td>M</td> </tr> </tbody> </table>	Codice	Descrizione	Qtà	UM	GN1275A0	GUARNIZIONE CAMINO SILICONE NERO XVC	4	PZ	VM1224A0	TUBOLARE TERMORETR 65MY 220MM 2 COLORI	0.200	M																
Codice	Descrizione	Qtà	UM																														
GN1275A0	GUARNIZIONE CAMINO SILICONE NERO XVC	4	PZ																														
VM1224A0	TUBOLARE TERMORETR 65MY 220MM 2 COLORI	0.200	M																														
VM1192A	COPERCHIO POST. SCROCCO MANIGLIA CT BT		KVM1191A	KIT SCROCCO MANIGLIA SX CT BT	<table border="1"> <thead> <tr> <th>Codice</th> <th>Descrizione</th> <th>Qtà</th> <th>UM</th> </tr> </thead> <tbody> <tr> <td>VI0239A1</td> <td>VITE AUTOFIL. 4.2X25 TCB+ INOX</td> <td>2</td> <td>PZ</td> </tr> <tr> <td>VI1220A1</td> <td>VITE AUTOFILETTA NTE 4.2X11 TCS+ MARUTE</td> <td>2</td> <td>PZ</td> </tr> <tr> <td>VM1191A2</td> <td>SCROCCO MANIGLIA SX CT BT</td> <td>1</td> <td>PZ</td> </tr> <tr> <td>VM1192A1</td> <td>COPERCHIO POST. SCROCCO MANIGLIA CT BT</td> <td>1</td> <td>PZ</td> </tr> <tr> <td>VM1224A0</td> <td>TUBOLARE TERMORETR 65MY 220MM 2 COLORI</td> <td>0.200</td> <td>M</td> </tr> <tr> <td>VM1460A0</td> <td>COPERCHIO DX SCROCCO PORTA XBC/XVC</td> <td>1</td> <td>PZ</td> </tr> </tbody> </table>	Codice	Descrizione	Qtà	UM	VI0239A1	VITE AUTOFIL. 4.2X25 TCB+ INOX	2	PZ	VI1220A1	VITE AUTOFILETTA NTE 4.2X11 TCS+ MARUTE	2	PZ	VM1191A2	SCROCCO MANIGLIA SX CT BT	1	PZ	VM1192A1	COPERCHIO POST. SCROCCO MANIGLIA CT BT	1	PZ	VM1224A0	TUBOLARE TERMORETR 65MY 220MM 2 COLORI	0.200	M	VM1460A0	COPERCHIO DX SCROCCO PORTA XBC/XVC	1	PZ
Codice	Descrizione	Qtà	UM																														
VI0239A1	VITE AUTOFIL. 4.2X25 TCB+ INOX	2	PZ																														
VI1220A1	VITE AUTOFILETTA NTE 4.2X11 TCS+ MARUTE	2	PZ																														
VM1191A2	SCROCCO MANIGLIA SX CT BT	1	PZ																														
VM1192A1	COPERCHIO POST. SCROCCO MANIGLIA CT BT	1	PZ																														
VM1224A0	TUBOLARE TERMORETR 65MY 220MM 2 COLORI	0.200	M																														
VM1460A0	COPERCHIO DX SCROCCO PORTA XBC/XVC	1	PZ																														

COMPONENTE			RICAMBIO																														
Codice	Descrizione	Immagine	Codice	Descrizione	Lista componenti																												
VM1192A	COPERCHIO POST. SCROCCO MANIGLIA CT BT		KVM1190A	KIT SCROCCO MANIGLIA DX CT BT	<table border="1"> <thead> <tr> <th>Codice</th> <th>Descrizione</th> <th>Qtà</th> <th>UM</th> </tr> </thead> <tbody> <tr> <td>VI0239A1</td> <td>VITE AUTOFIL. 4.2X25 TCB+ INOX</td> <td>2</td> <td>PZ</td> </tr> <tr> <td>VI1220A1</td> <td>VITE AUTOFILETTA NTE 4.2X11 TCS+ MARUTE</td> <td>2</td> <td>PZ</td> </tr> <tr> <td>VM1190A2</td> <td>SCROCCO MANIGLIA DX CT BT</td> <td>1</td> <td>PZ</td> </tr> <tr> <td>VM1192A1</td> <td>COPERCHIO POST. SCROCCO MANIGLIA CT BT</td> <td>1</td> <td>PZ</td> </tr> <tr> <td>VM1224A0</td> <td>TUBOLARE TERMORETR 65MY 220MM 2 COLORI</td> <td>0.200</td> <td>M</td> </tr> <tr> <td>VM1460A0</td> <td>COPERCHIO DX SCROCCO PORTA XBC/XVC</td> <td>1</td> <td>PZ</td> </tr> </tbody> </table>	Codice	Descrizione	Qtà	UM	VI0239A1	VITE AUTOFIL. 4.2X25 TCB+ INOX	2	PZ	VI1220A1	VITE AUTOFILETTA NTE 4.2X11 TCS+ MARUTE	2	PZ	VM1190A2	SCROCCO MANIGLIA DX CT BT	1	PZ	VM1192A1	COPERCHIO POST. SCROCCO MANIGLIA CT BT	1	PZ	VM1224A0	TUBOLARE TERMORETR 65MY 220MM 2 COLORI	0.200	M	VM1460A0	COPERCHIO DX SCROCCO PORTA XBC/XVC	1	PZ
Codice	Descrizione	Qtà	UM																														
VI0239A1	VITE AUTOFIL. 4.2X25 TCB+ INOX	2	PZ																														
VI1220A1	VITE AUTOFILETTA NTE 4.2X11 TCS+ MARUTE	2	PZ																														
VM1190A2	SCROCCO MANIGLIA DX CT BT	1	PZ																														
VM1192A1	COPERCHIO POST. SCROCCO MANIGLIA CT BT	1	PZ																														
VM1224A0	TUBOLARE TERMORETR 65MY 220MM 2 COLORI	0.200	M																														
VM1460A0	COPERCHIO DX SCROCCO PORTA XBC/XVC	1	PZ																														
VM1191A	SCROCCO MANIGLIA SX CT BT		KVM1191A	KIT SCROCCO MANIGLIA SX CT BT	<table border="1"> <thead> <tr> <th>Codice</th> <th>Descrizione</th> <th>Qtà</th> <th>UM</th> </tr> </thead> <tbody> <tr> <td>VI0239A1</td> <td>VITE AUTOFIL. 4.2X25 TCB+ INOX</td> <td>2</td> <td>PZ</td> </tr> <tr> <td>VI1220A1</td> <td>VITE AUTOFILETTA NTE 4.2X11 TCS+ MARUTE</td> <td>2</td> <td>PZ</td> </tr> <tr> <td>VM1191A2</td> <td>SCROCCO MANIGLIA SX CT BT</td> <td>1</td> <td>PZ</td> </tr> <tr> <td>VM1192A1</td> <td>COPERCHIO POST. SCROCCO MANIGLIA CT BT</td> <td>1</td> <td>PZ</td> </tr> <tr> <td>VM1224A0</td> <td>TUBOLARE TERMORETR 65MY 220MM 2 COLORI</td> <td>0.200</td> <td>M</td> </tr> <tr> <td>VM1460A0</td> <td>COPERCHIO DX SCROCCO PORTA XBC/XVC</td> <td>1</td> <td>PZ</td> </tr> </tbody> </table>	Codice	Descrizione	Qtà	UM	VI0239A1	VITE AUTOFIL. 4.2X25 TCB+ INOX	2	PZ	VI1220A1	VITE AUTOFILETTA NTE 4.2X11 TCS+ MARUTE	2	PZ	VM1191A2	SCROCCO MANIGLIA SX CT BT	1	PZ	VM1192A1	COPERCHIO POST. SCROCCO MANIGLIA CT BT	1	PZ	VM1224A0	TUBOLARE TERMORETR 65MY 220MM 2 COLORI	0.200	M	VM1460A0	COPERCHIO DX SCROCCO PORTA XBC/XVC	1	PZ
Codice	Descrizione	Qtà	UM																														
VI0239A1	VITE AUTOFIL. 4.2X25 TCB+ INOX	2	PZ																														
VI1220A1	VITE AUTOFILETTA NTE 4.2X11 TCS+ MARUTE	2	PZ																														
VM1191A2	SCROCCO MANIGLIA SX CT BT	1	PZ																														
VM1192A1	COPERCHIO POST. SCROCCO MANIGLIA CT BT	1	PZ																														
VM1224A0	TUBOLARE TERMORETR 65MY 220MM 2 COLORI	0.200	M																														
VM1460A0	COPERCHIO DX SCROCCO PORTA XBC/XVC	1	PZ																														

COMPONENTE			RICAMBIO																		
Codice	Descrizione	Immagine	Codice	Descrizione	Lista componenti																
VM1165B	STAFFA SUPERIORE PORTA CT BT		KVM1165B	KIT STAFFA SUPERIORE PORTA CT BT CL BL	<table border="1"> <thead> <tr> <th>Codice</th> <th>Descrizione</th> <th>Qtà</th> <th>UM</th> </tr> </thead> <tbody> <tr> <td>VM1165B0</td> <td>STAFFA SUPERIORE PORTA CT BT</td> <td>1</td> <td>PZ</td> </tr> <tr> <td>VM1224A0</td> <td>TUBOLARE TERMORETR 65MY 220MM 2 COLORI</td> <td>0.250</td> <td>M</td> </tr> </tbody> </table>	Codice	Descrizione	Qtà	UM	VM1165B0	STAFFA SUPERIORE PORTA CT BT	1	PZ	VM1224A0	TUBOLARE TERMORETR 65MY 220MM 2 COLORI	0.250	M				
Codice	Descrizione	Qtà	UM																		
VM1165B0	STAFFA SUPERIORE PORTA CT BT	1	PZ																		
VM1224A0	TUBOLARE TERMORETR 65MY 220MM 2 COLORI	0.250	M																		
VM1166A	COPERCHIO STAFFA SUPERIORE PORTA		KVM1166A	KIT COPERCHIO STAFFA SUPERIORE PORTA	<table border="1"> <thead> <tr> <th>Codice</th> <th>Descrizione</th> <th>Qtà</th> <th>UM</th> </tr> </thead> <tbody> <tr> <td>VM1166A0</td> <td>COPERCHIO STAFFA SUPERIORE PORTA</td> <td>1</td> <td>PZ</td> </tr> <tr> <td>VM1224A0</td> <td>TUBOLARE TERMORETR 65MY 220MM 2 COLORI</td> <td>0.200</td> <td>M</td> </tr> </tbody> </table>	Codice	Descrizione	Qtà	UM	VM1166A0	COPERCHIO STAFFA SUPERIORE PORTA	1	PZ	VM1224A0	TUBOLARE TERMORETR 65MY 220MM 2 COLORI	0.200	M				
Codice	Descrizione	Qtà	UM																		
VM1166A0	COPERCHIO STAFFA SUPERIORE PORTA	1	PZ																		
VM1224A0	TUBOLARE TERMORETR 65MY 220MM 2 COLORI	0.200	M																		
0H2560A	CONTROSTAFFA ZINCATA PORTA C.T		0H2560A0	CONTROSTAFFA ZINCATA PORTA C.T																	
VM1460A	COPERCHIO DX SCROCCO PORTA XBC/XVC		KVM1460A	KIT COPERCHIO DX SCROCCO PORTA XBC/XVC	<table border="1"> <thead> <tr> <th>Codice</th> <th>Descrizione</th> <th>Qtà</th> <th>UM</th> </tr> </thead> <tbody> <tr> <td>VI0239A1</td> <td>VITE AUTOFIL. 4.2X25 TCB+ INOX</td> <td>2</td> <td>PZ</td> </tr> <tr> <td>VM1224A0</td> <td>TUBOLARE TERMORETR 65MY 220MM 2 COLORI</td> <td>0.200</td> <td>M</td> </tr> <tr> <td>VM1460A0</td> <td>COPERCHIO DX SCROCCO PORTA XBC/XVC</td> <td>1</td> <td>PZ</td> </tr> </tbody> </table>	Codice	Descrizione	Qtà	UM	VI0239A1	VITE AUTOFIL. 4.2X25 TCB+ INOX	2	PZ	VM1224A0	TUBOLARE TERMORETR 65MY 220MM 2 COLORI	0.200	M	VM1460A0	COPERCHIO DX SCROCCO PORTA XBC/XVC	1	PZ
Codice	Descrizione	Qtà	UM																		
VI0239A1	VITE AUTOFIL. 4.2X25 TCB+ INOX	2	PZ																		
VM1224A0	TUBOLARE TERMORETR 65MY 220MM 2 COLORI	0.200	M																		
VM1460A0	COPERCHIO DX SCROCCO PORTA XBC/XVC	1	PZ																		
VM1461A	COPERCHIO SX SCROCCO PORTA XBC/XVC		VM1461A0	COPERCHIO SX SCROCCO PORTA XBC/XVC																	

COMPONENTE			RICAMBIO														
Codice	Descrizione	Immagine	Codice	Descrizione	Lista componenti												
VM1555A	SUPPORTO VENTOLA RAFFREDDAMENTO CT BT		KVN1164A	KIT VENTOLA RAFFREDDAMENTO 12VDC S.5/5E	<table border="1"> <thead> <tr> <th>Codice</th> <th>Descrizione</th> <th>Qtà</th> <th>UM</th> </tr> </thead> <tbody> <tr> <td>VN1164A0</td> <td>VENTOLA RAFFREDDAM ENTO 12VDC</td> <td>1</td> <td>PZ</td> </tr> <tr> <td>VN1164A0</td> <td>VENTOLA RAFFREDDAM ENTO 12VDC</td> <td>1</td> <td>PZ</td> </tr> </tbody> </table>	Codice	Descrizione	Qtà	UM	VN1164A0	VENTOLA RAFFREDDAM ENTO 12VDC	1	PZ	VN1164A0	VENTOLA RAFFREDDAM ENTO 12VDC	1	PZ
Codice	Descrizione	Qtà	UM														
VN1164A0	VENTOLA RAFFREDDAM ENTO 12VDC	1	PZ														
VN1164A0	VENTOLA RAFFREDDAM ENTO 12VDC	1	PZ														
VM1974A	PIASTRINA CHIUSURA CRUSCOTTO		VM1974A0	PIASTRINA CHIUSURA CRUSCOTTO													
VE1295A	MICROINTERRUTTO RE PORTA MK 16A 230V UL		KVE1295A	KIT MICROINTERRUTTO RE PORTA 16A 230V	<table border="1"> <thead> <tr> <th>Codice</th> <th>Descrizione</th> <th>Qtà</th> <th>UM</th> </tr> </thead> <tbody> <tr> <td>VE1295A0</td> <td>MICROINTERR UTTORE PORTA MK 16A 230V UL</td> <td>1</td> <td>PZ</td> </tr> <tr> <td>VM1224A0</td> <td>TUBOLARE TERMORETR 65MY 220MM 2 COLORI</td> <td>0.300</td> <td>M</td> </tr> </tbody> </table>	Codice	Descrizione	Qtà	UM	VE1295A0	MICROINTERR UTTORE PORTA MK 16A 230V UL	1	PZ	VM1224A0	TUBOLARE TERMORETR 65MY 220MM 2 COLORI	0.300	M
Codice	Descrizione	Qtà	UM														
VE1295A0	MICROINTERR UTTORE PORTA MK 16A 230V UL	1	PZ														
VM1224A0	TUBOLARE TERMORETR 65MY 220MM 2 COLORI	0.300	M														
VM1200A	PIASTRINA SUPPORTO MICROPORTA MECCANICO		VM1200A0	PIASTRINA SUPPORTO MICROPORTA MECCANICO													
0H6333A	CONTROSTAFFA PORTA FILETTATA BL CL		0H6333A0	CONTROSTAFFA PORTA FILETTATA BL CL													

COMPONENTE			RICAMBIO																																														
Codice	Descrizione	Immagine	Codice	Descrizione	Lista componenti																																												
RC1365A	RACCORDO JG FEMMINA 3/4"-10		KRC1365A	KIT ATTACCO ACQUA DI RETE 3/4"-10 O 8 JG	<table border="1"> <thead> <tr> <th>Codice</th> <th>Descrizione</th> <th>Qtà</th> <th>UM</th> </tr> </thead> <tbody> <tr> <td>GN1200A1</td> <td>GUARNIZIONE D24 RACCORDO 3/4 SILICONE</td> <td>1</td> <td>PZ</td> </tr> <tr> <td>RC1002A0</td> <td>RACCORDO RIDUZIONE CODOLO 10M-8F</td> <td>1</td> <td>PZ</td> </tr> <tr> <td>RC1365A0</td> <td>RACCORDO JG FEMMINA 3/4"-10</td> <td>1</td> <td>PZ</td> </tr> <tr> <td>VM1224A0</td> <td>TUBOLARE TERMORETR 65MY 220MM 2 COLORI</td> <td>0.150</td> <td>M</td> </tr> </tbody> </table>	Codice	Descrizione	Qtà	UM	GN1200A1	GUARNIZIONE D24 RACCORDO 3/4 SILICONE	1	PZ	RC1002A0	RACCORDO RIDUZIONE CODOLO 10M-8F	1	PZ	RC1365A0	RACCORDO JG FEMMINA 3/4"-10	1	PZ	VM1224A0	TUBOLARE TERMORETR 65MY 220MM 2 COLORI	0.150	M																								
Codice	Descrizione	Qtà	UM																																														
GN1200A1	GUARNIZIONE D24 RACCORDO 3/4 SILICONE	1	PZ																																														
RC1002A0	RACCORDO RIDUZIONE CODOLO 10M-8F	1	PZ																																														
RC1365A0	RACCORDO JG FEMMINA 3/4"-10	1	PZ																																														
VM1224A0	TUBOLARE TERMORETR 65MY 220MM 2 COLORI	0.150	M																																														
VL1034C	FILTRO ACQUA D10 MESH100		KVL1117A	KIT FILTRO+RID.PRESS. EUR MM =2016+LMTOP	<table border="1"> <thead> <tr> <th>Codice</th> <th>Descrizione</th> <th>Qtà</th> <th>UM</th> </tr> </thead> <tbody> <tr> <td>0H7472A1</td> <td>LAMIERA SUPPORTO DISTRIBUTOR</td> <td>1</td> <td>PZ</td> </tr> <tr> <td>RC1004A0</td> <td>RACCORDO Y Ø10-Ø8-8</td> <td>1</td> <td>PZ</td> </tr> <tr> <td>RC1243A0</td> <td>RACCORDO GOMITO CODOLO Ø10F-Ø10M</td> <td>1</td> <td>PZ</td> </tr> <tr> <td>RC1372A0</td> <td>RACCORDO DRITTO Ø10M-1/4 M CI</td> <td>2</td> <td>PZ</td> </tr> <tr> <td>VI1220A1</td> <td>VITE AUTOFILETTA NTE 4.2X11 TCS+ MARUTE</td> <td>4</td> <td>PZ</td> </tr> <tr> <td>VL1014B1</td> <td>RIDUTTORE DI PRESSIONE CON DISTRIBUTOR</td> <td>1</td> <td>PZ</td> </tr> <tr> <td>VL1014B2</td> <td>RIDUTTORE DI PRESSIONE CON DISTRIBUTOR</td> <td>1</td> <td>PZ</td> </tr> <tr> <td>VL1034C0</td> <td>FILTRO ACQUA D10 MESH100</td> <td>1</td> <td>PZ</td> </tr> <tr> <td>VL1062C0</td> <td>FORCELLA BLOCCA FILTRO-RIDUT TORE PRES.</td> <td>1</td> <td>PZ</td> </tr> <tr> <td>VM1054A0</td> <td>GHIERA RIDUTTORE DI PRESSIONE H7.8</td> <td>1</td> <td>PZ</td> </tr> </tbody> </table>	Codice	Descrizione	Qtà	UM	0H7472A1	LAMIERA SUPPORTO DISTRIBUTOR	1	PZ	RC1004A0	RACCORDO Y Ø10-Ø8-8	1	PZ	RC1243A0	RACCORDO GOMITO CODOLO Ø10F-Ø10M	1	PZ	RC1372A0	RACCORDO DRITTO Ø10M-1/4 M CI	2	PZ	VI1220A1	VITE AUTOFILETTA NTE 4.2X11 TCS+ MARUTE	4	PZ	VL1014B1	RIDUTTORE DI PRESSIONE CON DISTRIBUTOR	1	PZ	VL1014B2	RIDUTTORE DI PRESSIONE CON DISTRIBUTOR	1	PZ	VL1034C0	FILTRO ACQUA D10 MESH100	1	PZ	VL1062C0	FORCELLA BLOCCA FILTRO-RIDUT TORE PRES.	1	PZ	VM1054A0	GHIERA RIDUTTORE DI PRESSIONE H7.8	1	PZ
Codice	Descrizione	Qtà	UM																																														
0H7472A1	LAMIERA SUPPORTO DISTRIBUTOR	1	PZ																																														
RC1004A0	RACCORDO Y Ø10-Ø8-8	1	PZ																																														
RC1243A0	RACCORDO GOMITO CODOLO Ø10F-Ø10M	1	PZ																																														
RC1372A0	RACCORDO DRITTO Ø10M-1/4 M CI	2	PZ																																														
VI1220A1	VITE AUTOFILETTA NTE 4.2X11 TCS+ MARUTE	4	PZ																																														
VL1014B1	RIDUTTORE DI PRESSIONE CON DISTRIBUTOR	1	PZ																																														
VL1014B2	RIDUTTORE DI PRESSIONE CON DISTRIBUTOR	1	PZ																																														
VL1034C0	FILTRO ACQUA D10 MESH100	1	PZ																																														
VL1062C0	FORCELLA BLOCCA FILTRO-RIDUT TORE PRES.	1	PZ																																														
VM1054A0	GHIERA RIDUTTORE DI PRESSIONE H7.8	1	PZ																																														

COMPONENTE			RICAMBIO																						
Codice	Descrizione	Immagine	Codice	Descrizione	Lista componenti																				
VL1034C	FILTRO ACQUA D10 MESH100		KVL1034C	KIT RICAMBIO FILTRO ACQUA MESH100 Ø8-Ø10	<table border="1"> <thead> <tr> <th>Codice</th> <th>Descrizione</th> <th>Qtà</th> <th>UM</th> </tr> </thead> <tbody> <tr> <td>RC1002A0</td> <td>RACCORDO RIDUZIONE CODOLO 10M-8F</td> <td>2</td> <td>PZ</td> </tr> <tr> <td>VL1034C0</td> <td>FILTRO ACQUA D10 MESH100</td> <td>1</td> <td>PZ</td> </tr> <tr> <td>VL1062C0</td> <td>FORCELLA BLOCCA FILTRO-RIDUT TORE PRES.</td> <td>1</td> <td>PZ</td> </tr> <tr> <td>VM1224A0</td> <td>TUBOLARE TERMORETR 65MY 220MM 2 COLORI</td> <td>0.300</td> <td>M</td> </tr> </tbody> </table>	Codice	Descrizione	Qtà	UM	RC1002A0	RACCORDO RIDUZIONE CODOLO 10M-8F	2	PZ	VL1034C0	FILTRO ACQUA D10 MESH100	1	PZ	VL1062C0	FORCELLA BLOCCA FILTRO-RIDUT TORE PRES.	1	PZ	VM1224A0	TUBOLARE TERMORETR 65MY 220MM 2 COLORI	0.300	M
					Codice	Descrizione	Qtà	UM																	
					RC1002A0	RACCORDO RIDUZIONE CODOLO 10M-8F	2	PZ																	
					VL1034C0	FILTRO ACQUA D10 MESH100	1	PZ																	
VL1062C0	FORCELLA BLOCCA FILTRO-RIDUT TORE PRES.	1	PZ																						
VM1224A0	TUBOLARE TERMORETR 65MY 220MM 2 COLORI	0.300	M																						
TB2237A	TB2243A - Ø10 ALLACCIAMENTO RETE 1,5M		KTB2599A	KIT TUBO PET Ø10 L=100M TB2243A	<table border="1"> <thead> <tr> <th>Codice</th> <th>Descrizione</th> <th>Qtà</th> <th>UM</th> </tr> </thead> <tbody> <tr> <td>TB2243A0</td> <td>TUBO D10 PE TRASPARENT</td> <td>100</td> <td>M</td> </tr> <tr> <td>VM1059A1</td> <td>FILM TERMORETRA IBILE H800</td> <td>1.500</td> <td>M</td> </tr> </tbody> </table>	Codice	Descrizione	Qtà	UM	TB2243A0	TUBO D10 PE TRASPARENT	100	M	VM1059A1	FILM TERMORETRA IBILE H800	1.500	M								
			Codice	Descrizione	Qtà	UM																			
TB2243A0	TUBO D10 PE TRASPARENT	100	M																						
VM1059A1	FILM TERMORETRA IBILE H800	1.500	M																						
KTB2598A	KIT TUBO PET Ø10 L=3M TB2243A0	<table border="1"> <thead> <tr> <th>Codice</th> <th>Descrizione</th> <th>Qtà</th> <th>UM</th> </tr> </thead> <tbody> <tr> <td>TB2243A0</td> <td>TUBO D10 PE TRASPARENT</td> <td>3</td> <td>M</td> </tr> </tbody> </table>	Codice	Descrizione	Qtà	UM	TB2243A0	TUBO D10 PE TRASPARENT	3	M															
Codice	Descrizione	Qtà	UM																						
TB2243A0	TUBO D10 PE TRASPARENT	3	M																						
RC1360A	RACCORDO GOMITO JG 10-10		KRC1360A	KIT 10 PZ RACCORDO GOMITO JG Ø10-Ø1	<table border="1"> <thead> <tr> <th>Codice</th> <th>Descrizione</th> <th>Qtà</th> <th>UM</th> </tr> </thead> <tbody> <tr> <td>RC1360A0</td> <td>RACCORDO GOMITO JG 10-10</td> <td>10</td> <td>PZ</td> </tr> <tr> <td>VM1224A0</td> <td>TUBOLARE TERMORETR 65MY 220MM 2 COLORI</td> <td>0.250</td> <td>M</td> </tr> </tbody> </table>	Codice	Descrizione	Qtà	UM	RC1360A0	RACCORDO GOMITO JG 10-10	10	PZ	VM1224A0	TUBOLARE TERMORETR 65MY 220MM 2 COLORI	0.250	M								
					Codice	Descrizione	Qtà	UM																	
RC1360A0	RACCORDO GOMITO JG 10-10	10	PZ																						
VM1224A0	TUBOLARE TERMORETR 65MY 220MM 2 COLORI	0.250	M																						
EL1349A	CLIP BLOCCA PINZETTA RACCORDI D10		KEL1349A	KIT 10 PZ BLOCCA PINZETTA RACCORDI Ø10	<table border="1"> <thead> <tr> <th>Codice</th> <th>Descrizione</th> <th>Qtà</th> <th>UM</th> </tr> </thead> <tbody> <tr> <td>EL1349A0</td> <td>CLIP BLOCCA PINZETTA RACCORDI D1</td> <td>10</td> <td>PZ</td> </tr> <tr> <td>VM1224A0</td> <td>TUBOLARE TERMORETR 65MY 220MM 2 COLORI</td> <td>0.200</td> <td>M</td> </tr> </tbody> </table>	Codice	Descrizione	Qtà	UM	EL1349A0	CLIP BLOCCA PINZETTA RACCORDI D1	10	PZ	VM1224A0	TUBOLARE TERMORETR 65MY 220MM 2 COLORI	0.200	M								
					Codice	Descrizione	Qtà	UM																	
EL1349A0	CLIP BLOCCA PINZETTA RACCORDI D1	10	PZ																						
VM1224A0	TUBOLARE TERMORETR 65MY 220MM 2 COLORI	0.200	M																						

COMPONENTE			RICAMBIO		
<i>Codice</i>	<i>Descrizione</i>	<i>Immagine</i>	<i>Codice</i>	<i>Descrizione</i>	<i>Lista componenti</i>
0D2256A	COPERCHIO CHEFLUX		0D2256A0	COPERCHIO CHEFLUX	
0E1342A	FONDO ESTERNO CHEFLUX		0E1342A0	FONDO ESTERNO CHEFLUX	
0D2257A	FIANCO SINISTRO CHEFLUX XV393		0D2257A0	FIANCO SINISTRO CHEFLUX XV393	
0D2258A	FIANCO DESTRO CHEFLUX XV393		0D2258A0	FIANCO DESTRO CHEFLUX XV393	
0F1481A	SCHIENA CHEFLUX XV393		0F1481A0	SCHIENA CHEFLUX XV393	

COMPONENTE			RICAMBIO																						
Codice	Descrizione	Immagine	Codice	Descrizione	Lista componenti																				
0H7104A	LAMIERA CRUSCOTTO CHEFLUX		0H7104A0	LAMIERA CRUSCOTTO CHEFLUX																					
PD1066B	PIEDE H100 PLASTICA BICOMPONENTE		KPD1066B	KIT PIEDINO SERIE E H100	<table border="1"> <thead> <tr> <th>Codice</th> <th>Descrizione</th> <th>Qtà</th> <th>UM</th> </tr> </thead> <tbody> <tr> <td>PD1063A0</td> <td>STAFFA BLOCCAGGIO PIEDE CT BT</td> <td>1</td> <td>PZ</td> </tr> <tr> <td>PD1066B0</td> <td>PIEDE H100 PLASTICA BICOMPONENTE</td> <td>1</td> <td>PZ</td> </tr> <tr> <td>VI1220A1</td> <td>VITE AUTOFILETTA NTE 4.2X11 TCS+ MARUTE</td> <td>5</td> <td>PZ</td> </tr> <tr> <td>VM1224A0</td> <td>TUBOLARE TERMORETR 65MY 220MM 2 COLORI</td> <td>0.300</td> <td>M</td> </tr> </tbody> </table>	Codice	Descrizione	Qtà	UM	PD1063A0	STAFFA BLOCCAGGIO PIEDE CT BT	1	PZ	PD1066B0	PIEDE H100 PLASTICA BICOMPONENTE	1	PZ	VI1220A1	VITE AUTOFILETTA NTE 4.2X11 TCS+ MARUTE	5	PZ	VM1224A0	TUBOLARE TERMORETR 65MY 220MM 2 COLORI	0.300	M
Codice	Descrizione	Qtà	UM																						
PD1063A0	STAFFA BLOCCAGGIO PIEDE CT BT	1	PZ																						
PD1066B0	PIEDE H100 PLASTICA BICOMPONENTE	1	PZ																						
VI1220A1	VITE AUTOFILETTA NTE 4.2X11 TCS+ MARUTE	5	PZ																						
VM1224A0	TUBOLARE TERMORETR 65MY 220MM 2 COLORI	0.300	M																						
PD1063A	STAFFA BLOCCAGGIO PIEDE CT BT		KPD1063A	KIT STAFFA BLOCCAGGIO PIEDE	<table border="1"> <thead> <tr> <th>Codice</th> <th>Descrizione</th> <th>Qtà</th> <th>UM</th> </tr> </thead> <tbody> <tr> <td>PD1063A0</td> <td>STAFFA BLOCCAGGIO PIEDE CT BT</td> <td>4</td> <td>PZ</td> </tr> <tr> <td>VI1950A0</td> <td>VITE AUTOFORANT E 4,2X13 TCB INOX</td> <td>8</td> <td>PZ</td> </tr> <tr> <td>VM1224A0</td> <td>TUBOLARE TERMORETR 65MY 220MM 2 COLORI</td> <td>0.300</td> <td>M</td> </tr> </tbody> </table>	Codice	Descrizione	Qtà	UM	PD1063A0	STAFFA BLOCCAGGIO PIEDE CT BT	4	PZ	VI1950A0	VITE AUTOFORANT E 4,2X13 TCB INOX	8	PZ	VM1224A0	TUBOLARE TERMORETR 65MY 220MM 2 COLORI	0.300	M				
Codice	Descrizione	Qtà	UM																						
PD1063A0	STAFFA BLOCCAGGIO PIEDE CT BT	4	PZ																						
VI1950A0	VITE AUTOFORANT E 4,2X13 TCB INOX	8	PZ																						
VM1224A0	TUBOLARE TERMORETR 65MY 220MM 2 COLORI	0.300	M																						
0H1019A	LAMIERA RINFORZO PIEDI H100 CT		0H1019A2	LAMIERA RINFORZO PIEDI H100 CT																					

COMPONENTE			RICAMBIO																						
Codice	Descrizione	Immagine	Codice	Descrizione	Lista componenti																				
VM1762A	SUPPORTO LAMPADA INTERNO		KVM1762A	KIT SUPPORTO INTERNO LAMPADA	<table border="1"> <thead> <tr> <th>Codice</th> <th>Descrizione</th> <th>Qtà</th> <th>UM</th> </tr> </thead> <tbody> <tr> <td>VM1224A0</td> <td>TUBOLARE TERMORETR 65MY 220MM 2 COLORI</td> <td>0.150</td> <td>M</td> </tr> <tr> <td>VM1762A0</td> <td>SUPPORTO LAMPADA INTERNO</td> <td>1</td> <td>PZ</td> </tr> </tbody> </table>	Codice	Descrizione	Qtà	UM	VM1224A0	TUBOLARE TERMORETR 65MY 220MM 2 COLORI	0.150	M	VM1762A0	SUPPORTO LAMPADA INTERNO	1	PZ								
Codice	Descrizione	Qtà	UM																						
VM1224A0	TUBOLARE TERMORETR 65MY 220MM 2 COLORI	0.150	M																						
VM1762A0	SUPPORTO LAMPADA INTERNO	1	PZ																						
VE1530A	GEMMA ELLITTICA AZZURRA TERMOMETRO ORO		KVE1530A	KIT GEMMA AZZURRA TERMOMETRO ORO	<table border="1"> <thead> <tr> <th>Codice</th> <th>Descrizione</th> <th>Qtà</th> <th>UM</th> </tr> </thead> <tbody> <tr> <td>VE1530A0</td> <td>GEMMA ELLITTICA AZZURRA TERMOMETR O ORO</td> <td>1</td> <td>PZ</td> </tr> <tr> <td>VM1224A0</td> <td>TUBOLARE TERMORETR 65MY 220MM 2 COLORI</td> <td>0.150</td> <td>M</td> </tr> <tr> <td>VM1762A0</td> <td>SUPPORTO LAMPADA INTERNO</td> <td>1</td> <td>PZ</td> </tr> <tr> <td>VM2009A0</td> <td>SUPPORTO ELLITTICO D16 ARGENTO</td> <td>1</td> <td>PZ</td> </tr> </tbody> </table>	Codice	Descrizione	Qtà	UM	VE1530A0	GEMMA ELLITTICA AZZURRA TERMOMETR O ORO	1	PZ	VM1224A0	TUBOLARE TERMORETR 65MY 220MM 2 COLORI	0.150	M	VM1762A0	SUPPORTO LAMPADA INTERNO	1	PZ	VM2009A0	SUPPORTO ELLITTICO D16 ARGENTO	1	PZ
Codice	Descrizione	Qtà	UM																						
VE1530A0	GEMMA ELLITTICA AZZURRA TERMOMETR O ORO	1	PZ																						
VM1224A0	TUBOLARE TERMORETR 65MY 220MM 2 COLORI	0.150	M																						
VM1762A0	SUPPORTO LAMPADA INTERNO	1	PZ																						
VM2009A0	SUPPORTO ELLITTICO D16 ARGENTO	1	PZ																						
TM1005A	TIMER MI2 60 MIN 250V 16A		KTM1005A	KIT TIMER 60 MIN	<table border="1"> <thead> <tr> <th>Codice</th> <th>Descrizione</th> <th>Qtà</th> <th>UM</th> </tr> </thead> <tbody> <tr> <td>TM1005A0</td> <td>TIMER MI2 60 MIN 250V 16A</td> <td>1</td> <td>PZ</td> </tr> <tr> <td>VI1850A0</td> <td>VITE M4X6 TCB+ NICHELATA</td> <td>2</td> <td>PZ</td> </tr> <tr> <td>VM1224A0</td> <td>TUBOLARE TERMORETR 65MY 220MM 2 COLORI</td> <td>0.250</td> <td>M</td> </tr> </tbody> </table>	Codice	Descrizione	Qtà	UM	TM1005A0	TIMER MI2 60 MIN 250V 16A	1	PZ	VI1850A0	VITE M4X6 TCB+ NICHELATA	2	PZ	VM1224A0	TUBOLARE TERMORETR 65MY 220MM 2 COLORI	0.250	M				
Codice	Descrizione	Qtà	UM																						
TM1005A0	TIMER MI2 60 MIN 250V 16A	1	PZ																						
VI1850A0	VITE M4X6 TCB+ NICHELATA	2	PZ																						
VM1224A0	TUBOLARE TERMORETR 65MY 220MM 2 COLORI	0.250	M																						
TR1100A	TERMOSTATO REG. 269°C 55.19052.80		KTR1100A	KIT TERMOSTATO REGOLAZ. 269°C	<table border="1"> <thead> <tr> <th>Codice</th> <th>Descrizione</th> <th>Qtà</th> <th>UM</th> </tr> </thead> <tbody> <tr> <td>TR1100A0</td> <td>TERMOSTATO REG. 269°C 55.19052.80</td> <td>1</td> <td>PZ</td> </tr> <tr> <td>VI1850A0</td> <td>VITE M4X6 TCB+ NICHELATA</td> <td>2</td> <td>PZ</td> </tr> </tbody> </table>	Codice	Descrizione	Qtà	UM	TR1100A0	TERMOSTATO REG. 269°C 55.19052.80	1	PZ	VI1850A0	VITE M4X6 TCB+ NICHELATA	2	PZ								
Codice	Descrizione	Qtà	UM																						
TR1100A0	TERMOSTATO REG. 269°C 55.19052.80	1	PZ																						
VI1850A0	VITE M4X6 TCB+ NICHELATA	2	PZ																						

COMPONENTE			RICAMBIO																														
Codice	Descrizione	Immagine	Codice	Descrizione	Lista componenti																												
TM1001C	BUZZER ELETTRONICO 15S 120V		KTM1001C	KIT BUZZER 15 SEC	<table border="1"> <thead> <tr> <th>Codice</th> <th>Descrizione</th> <th>Qtà</th> <th>UM</th> </tr> </thead> <tbody> <tr> <td>TM1001C2</td> <td>BUZZER ELETTRONICO 15S 120V</td> <td>1</td> <td>PZ</td> </tr> <tr> <td>VI1220A1</td> <td>VITE AUTOFILETTA NTE 4.2X11 TCS+ MARUTE</td> <td>3</td> <td>PZ</td> </tr> <tr> <td>VI1850A0</td> <td>VITE M4X6 TCB+ NICHELATA</td> <td>3</td> <td>PZ</td> </tr> <tr> <td>VM1745A0</td> <td>SUPPORTO PER SCHEDA</td> <td>3</td> <td>PZ</td> </tr> </tbody> </table>	Codice	Descrizione	Qtà	UM	TM1001C2	BUZZER ELETTRONICO 15S 120V	1	PZ	VI1220A1	VITE AUTOFILETTA NTE 4.2X11 TCS+ MARUTE	3	PZ	VI1850A0	VITE M4X6 TCB+ NICHELATA	3	PZ	VM1745A0	SUPPORTO PER SCHEDA	3	PZ								
Codice	Descrizione	Qtà	UM																														
TM1001C2	BUZZER ELETTRONICO 15S 120V	1	PZ																														
VI1220A1	VITE AUTOFILETTA NTE 4.2X11 TCS+ MARUTE	3	PZ																														
VI1850A0	VITE M4X6 TCB+ NICHELATA	3	PZ																														
VM1745A0	SUPPORTO PER SCHEDA	3	PZ																														
VE1585A	GEMMA ELLITTICA AZZURRA SINUSOIDE ORO		KLP1014A	KIT RICAMBIO SPIA AZZURRA SINUSOID	<table border="1"> <thead> <tr> <th>Codice</th> <th>Descrizione</th> <th>Qtà</th> <th>UM</th> </tr> </thead> <tbody> <tr> <td>VE1170A0</td> <td>SUPPORTO D16 ELLITTICO NICHEL OPAC</td> <td>2</td> <td>PZ</td> </tr> <tr> <td>VE1535A1</td> <td>LUCE SPIA LED BIANCO 230V</td> <td>2</td> <td>PZ</td> </tr> <tr> <td>VE1585A0</td> <td>GEMMA ELLITTICA AZZURRA SINUSOIDE ORO</td> <td>2</td> <td>PZ</td> </tr> <tr> <td>VM1224A0</td> <td>TUBOLARE TERMORETR 65MY 220MM 2 COLORI</td> <td>0.200</td> <td>M</td> </tr> <tr> <td>VM1762A0</td> <td>SUPPORTO LAMPADA INTERNO</td> <td>2</td> <td>PZ</td> </tr> <tr> <td>VM2009A0</td> <td>SUPPORTO ELLITTICO D16 ARGENTO</td> <td>1</td> <td>PZ</td> </tr> </tbody> </table>	Codice	Descrizione	Qtà	UM	VE1170A0	SUPPORTO D16 ELLITTICO NICHEL OPAC	2	PZ	VE1535A1	LUCE SPIA LED BIANCO 230V	2	PZ	VE1585A0	GEMMA ELLITTICA AZZURRA SINUSOIDE ORO	2	PZ	VM1224A0	TUBOLARE TERMORETR 65MY 220MM 2 COLORI	0.200	M	VM1762A0	SUPPORTO LAMPADA INTERNO	2	PZ	VM2009A0	SUPPORTO ELLITTICO D16 ARGENTO	1	PZ
Codice	Descrizione	Qtà	UM																														
VE1170A0	SUPPORTO D16 ELLITTICO NICHEL OPAC	2	PZ																														
VE1535A1	LUCE SPIA LED BIANCO 230V	2	PZ																														
VE1585A0	GEMMA ELLITTICA AZZURRA SINUSOIDE ORO	2	PZ																														
VM1224A0	TUBOLARE TERMORETR 65MY 220MM 2 COLORI	0.200	M																														
VM1762A0	SUPPORTO LAMPADA INTERNO	2	PZ																														
VM2009A0	SUPPORTO ELLITTICO D16 ARGENTO	1	PZ																														
VM2009A	SUPPORTO ELLITTICO D16 ARGENTO		KVM2009A	KIT SUPPORTO ELLITTICO D16 ARGENTO	<table border="1"> <thead> <tr> <th>Codice</th> <th>Descrizione</th> <th>Qtà</th> <th>UM</th> </tr> </thead> <tbody> <tr> <td>VM1224A0</td> <td>TUBOLARE TERMORETR 65MY 220MM 2 COLORI</td> <td>0.150</td> <td>M</td> </tr> <tr> <td>VM2009A0</td> <td>SUPPORTO ELLITTICO D16 ARGENTO</td> <td>1</td> <td>PZ</td> </tr> </tbody> </table>	Codice	Descrizione	Qtà	UM	VM1224A0	TUBOLARE TERMORETR 65MY 220MM 2 COLORI	0.150	M	VM2009A0	SUPPORTO ELLITTICO D16 ARGENTO	1	PZ																
Codice	Descrizione	Qtà	UM																														
VM1224A0	TUBOLARE TERMORETR 65MY 220MM 2 COLORI	0.150	M																														
VM2009A0	SUPPORTO ELLITTICO D16 ARGENTO	1	PZ																														

COMPONENTE			RICAMBIO																										
Codice	Descrizione	Immagine	Codice	Descrizione	Lista componenti																								
VE1561A	INTERRUTTORE BIPOLARE NA/NA		KVE0108A	KIT TASTO 0 - 1 ARGENTO OPACO	<table border="1"> <thead> <tr> <th>Codice</th> <th>Descrizione</th> <th>Qtà</th> <th>UM</th> </tr> </thead> <tbody> <tr> <td>VE1170A0</td> <td>SUPPORTO D16 ELLITTICO NICHEL OPAC</td> <td>1</td> <td>PZ</td> </tr> <tr> <td>VE1561A0</td> <td>INTERRUTTO RE BIPOLARE NA/NA</td> <td>1</td> <td>PZ</td> </tr> <tr> <td>VM1224A0</td> <td>TUBOLARE TERMORETR 65MY 220MM 2 COLORI</td> <td>0.200</td> <td>M</td> </tr> <tr> <td>VM1761A0</td> <td>SUPPORTO ELLITTICO NERO</td> <td>1</td> <td>PZ</td> </tr> <tr> <td>VM1776A0</td> <td>TASTO ARGENTO OPACO "0-1" ORO</td> <td>1</td> <td>PZ</td> </tr> </tbody> </table>	Codice	Descrizione	Qtà	UM	VE1170A0	SUPPORTO D16 ELLITTICO NICHEL OPAC	1	PZ	VE1561A0	INTERRUTTO RE BIPOLARE NA/NA	1	PZ	VM1224A0	TUBOLARE TERMORETR 65MY 220MM 2 COLORI	0.200	M	VM1761A0	SUPPORTO ELLITTICO NERO	1	PZ	VM1776A0	TASTO ARGENTO OPACO "0-1" ORO	1	PZ
Codice	Descrizione	Qtà	UM																										
VE1170A0	SUPPORTO D16 ELLITTICO NICHEL OPAC	1	PZ																										
VE1561A0	INTERRUTTO RE BIPOLARE NA/NA	1	PZ																										
VM1224A0	TUBOLARE TERMORETR 65MY 220MM 2 COLORI	0.200	M																										
VM1761A0	SUPPORTO ELLITTICO NERO	1	PZ																										
VM1776A0	TASTO ARGENTO OPACO "0-1" ORO	1	PZ																										
VM2007A	TASTO ARGENTO OPACO VELOCITA VENTOLA		KVM2007A	KIT TASTO VELOCITA VENTOLA	<table border="1"> <thead> <tr> <th>Codice</th> <th>Descrizione</th> <th>Qtà</th> <th>UM</th> </tr> </thead> <tbody> <tr> <td>VM1224A0</td> <td>TUBOLARE TERMORETR 65MY 220MM 2 COLORI</td> <td>0.150</td> <td>M</td> </tr> <tr> <td>VM2007A0</td> <td>TASTO ARGENTO OPACO VELOCITA VENTOLA</td> <td>1</td> <td>PZ</td> </tr> </tbody> </table>	Codice	Descrizione	Qtà	UM	VM1224A0	TUBOLARE TERMORETR 65MY 220MM 2 COLORI	0.150	M	VM2007A0	TASTO ARGENTO OPACO VELOCITA VENTOLA	1	PZ												
Codice	Descrizione	Qtà	UM																										
VM1224A0	TUBOLARE TERMORETR 65MY 220MM 2 COLORI	0.150	M																										
VM2007A0	TASTO ARGENTO OPACO VELOCITA VENTOLA	1	PZ																										
VE1556A	REGOLATORE ENERGIA 240V		KVE1556A	KIT REGOLATORE ENERGIA EX-VE023	<table border="1"> <thead> <tr> <th>Codice</th> <th>Descrizione</th> <th>Qtà</th> <th>UM</th> </tr> </thead> <tbody> <tr> <td>MN1000A0</td> <td>MANOPOLA CON INDICE SERIGR. ARGENTO</td> <td>1</td> <td>PZ</td> </tr> <tr> <td>MN1085A0</td> <td>GHIERA SERIGRAFATA REGOLATORE</td> <td>1</td> <td>PZ</td> </tr> <tr> <td>VE1556A0</td> <td>REGOLATORE ENERGIA 240V</td> <td>1</td> <td>PZ</td> </tr> <tr> <td>VI1850A0</td> <td>VITE M4X6 TCB+ NICHELATA</td> <td>2</td> <td>PZ</td> </tr> </tbody> </table>	Codice	Descrizione	Qtà	UM	MN1000A0	MANOPOLA CON INDICE SERIGR. ARGENTO	1	PZ	MN1085A0	GHIERA SERIGRAFATA REGOLATORE	1	PZ	VE1556A0	REGOLATORE ENERGIA 240V	1	PZ	VI1850A0	VITE M4X6 TCB+ NICHELATA	2	PZ				
Codice	Descrizione	Qtà	UM																										
MN1000A0	MANOPOLA CON INDICE SERIGR. ARGENTO	1	PZ																										
MN1085A0	GHIERA SERIGRAFATA REGOLATORE	1	PZ																										
VE1556A0	REGOLATORE ENERGIA 240V	1	PZ																										
VI1850A0	VITE M4X6 TCB+ NICHELATA	2	PZ																										
			KMN1110B	KIT GHIERA SPIDOCOOK MANUAL	<table border="1"> <thead> <tr> <th>Codice</th> <th>Descrizione</th> <th>Qtà</th> <th>UM</th> </tr> </thead> <tbody> <tr> <td>MN1110B0</td> <td>GHIERA INDICE STAMPATO SPIDOCOOK</td> <td>1</td> <td>PZ</td> </tr> <tr> <td>VM1224A0</td> <td>TUBOLARE TERMORETR 65MY 220MM 2 COLORI</td> <td>0.150</td> <td>M</td> </tr> </tbody> </table>	Codice	Descrizione	Qtà	UM	MN1110B0	GHIERA INDICE STAMPATO SPIDOCOOK	1	PZ	VM1224A0	TUBOLARE TERMORETR 65MY 220MM 2 COLORI	0.150	M												
Codice	Descrizione	Qtà	UM																										
MN1110B0	GHIERA INDICE STAMPATO SPIDOCOOK	1	PZ																										
VM1224A0	TUBOLARE TERMORETR 65MY 220MM 2 COLORI	0.150	M																										

COMPONENTE			RICAMBIO																						
Codice	Descrizione	Immagine	Codice	Descrizione	Lista componenti																				
VE1556A	REGOLATORE ENERGIA 240V		KMN1086A	KIT MANOPOLA E GHIERA SP200/300	<table border="1"> <thead> <tr> <th>Codice</th> <th>Descrizione</th> <th>Qtà</th> <th>UM</th> </tr> </thead> <tbody> <tr> <td>MN1086A0</td> <td>MANOPOLA REG ENERG 80-400°C SP200/300</td> <td>1</td> <td>PZ</td> </tr> <tr> <td>MN1110A0</td> <td>GHIERA CON INDICE STAMPATO XP</td> <td>1</td> <td>PZ</td> </tr> <tr> <td>VI1850A0</td> <td>VITE M4X6 TCB+ NICHELATA</td> <td>2</td> <td>PZ</td> </tr> <tr> <td>VM1224A0</td> <td>TUBOLARE TERMORETR 65MY 220MM 2 COLORI</td> <td>0.200</td> <td>M</td> </tr> </tbody> </table>	Codice	Descrizione	Qtà	UM	MN1086A0	MANOPOLA REG ENERG 80-400°C SP200/300	1	PZ	MN1110A0	GHIERA CON INDICE STAMPATO XP	1	PZ	VI1850A0	VITE M4X6 TCB+ NICHELATA	2	PZ	VM1224A0	TUBOLARE TERMORETR 65MY 220MM 2 COLORI	0.200	M
Codice	Descrizione	Qtà	UM																						
MN1086A0	MANOPOLA REG ENERG 80-400°C SP200/300	1	PZ																						
MN1110A0	GHIERA CON INDICE STAMPATO XP	1	PZ																						
VI1850A0	VITE M4X6 TCB+ NICHELATA	2	PZ																						
VM1224A0	TUBOLARE TERMORETR 65MY 220MM 2 COLORI	0.200	M																						
MN1112A	MANOPOLA TIMER CHEFLUX BAKERLU		KMN1112A	KIT MANOPOLA TIMER CL BL	<table border="1"> <thead> <tr> <th>Codice</th> <th>Descrizione</th> <th>Qtà</th> <th>UM</th> </tr> </thead> <tbody> <tr> <td>MN1112A1</td> <td>MANOPOLA TIMER CHEFLUX BAKERLUX</td> <td>1</td> <td>PZ</td> </tr> <tr> <td>VM1224A0</td> <td>TUBOLARE TERMORETR 65MY 220MM 2 COLORI</td> <td>0.200</td> <td>M</td> </tr> </tbody> </table>	Codice	Descrizione	Qtà	UM	MN1112A1	MANOPOLA TIMER CHEFLUX BAKERLUX	1	PZ	VM1224A0	TUBOLARE TERMORETR 65MY 220MM 2 COLORI	0.200	M								
Codice	Descrizione	Qtà	UM																						
MN1112A1	MANOPOLA TIMER CHEFLUX BAKERLUX	1	PZ																						
VM1224A0	TUBOLARE TERMORETR 65MY 220MM 2 COLORI	0.200	M																						
MN1111A	MANOPOLA LUX TERMOSTATO GRADI CELSIUS		KMN1111A	MANOPOLA TERMOSTATO LUX GRADI CELSIUS	<table border="1"> <thead> <tr> <th>Codice</th> <th>Descrizione</th> <th>Qtà</th> <th>UM</th> </tr> </thead> <tbody> <tr> <td>MN1111A1</td> <td>MANOPOLA LUX TERMOSTATO GRADI CELSIU</td> <td>1</td> <td>PZ</td> </tr> <tr> <td>VM1224A0</td> <td>TUBOLARE TERMORETR 65MY 220MM 2 COLORI</td> <td>0.200</td> <td>M</td> </tr> </tbody> </table>	Codice	Descrizione	Qtà	UM	MN1111A1	MANOPOLA LUX TERMOSTATO GRADI CELSIU	1	PZ	VM1224A0	TUBOLARE TERMORETR 65MY 220MM 2 COLORI	0.200	M								
Codice	Descrizione	Qtà	UM																						
MN1111A1	MANOPOLA LUX TERMOSTATO GRADI CELSIU	1	PZ																						
VM1224A0	TUBOLARE TERMORETR 65MY 220MM 2 COLORI	0.200	M																						
VM2203A	CRUSCOTTO MANUALE CHEFLUX		KVM2203A	KIT CRUSCOTTO CHEFLUX XV393	<table border="1"> <thead> <tr> <th>Codice</th> <th>Descrizione</th> <th>Qtà</th> <th>UM</th> </tr> </thead> <tbody> <tr> <td>VE1530A0</td> <td>GEMMA ELLITTICA AZZURRA TERMOMETR O ORO</td> <td>1</td> <td>PZ</td> </tr> <tr> <td>VE1535A1</td> <td>LUCE SPIA LED BIANCO 230V</td> <td>2</td> <td>PZ</td> </tr> <tr> <td>VE1561A0</td> <td>INTERRUTTO RE BIPOLORE NA/NA</td> <td>1</td> <td>PZ</td> </tr> <tr> <td>VE1585A0</td> <td>GEMMA ELLITTICA AZZURRA SINUSOIDE ORO</td> <td>1</td> <td>PZ</td> </tr> </tbody> </table>	Codice	Descrizione	Qtà	UM	VE1530A0	GEMMA ELLITTICA AZZURRA TERMOMETR O ORO	1	PZ	VE1535A1	LUCE SPIA LED BIANCO 230V	2	PZ	VE1561A0	INTERRUTTO RE BIPOLORE NA/NA	1	PZ	VE1585A0	GEMMA ELLITTICA AZZURRA SINUSOIDE ORO	1	PZ
Codice	Descrizione	Qtà	UM																						
VE1530A0	GEMMA ELLITTICA AZZURRA TERMOMETR O ORO	1	PZ																						
VE1535A1	LUCE SPIA LED BIANCO 230V	2	PZ																						
VE1561A0	INTERRUTTO RE BIPOLORE NA/NA	1	PZ																						
VE1585A0	GEMMA ELLITTICA AZZURRA SINUSOIDE ORO	1	PZ																						

COMPONENTE			RICAMBIO																																		
Codice	Descrizione	Immagine	Codice	Descrizione	Lista componenti																																
VM2203A	CRUSCOTTO MANUALE CHEFLUX		KVM2203A	KIT CRUSCOTTO CHEFLUX XV393	<table border="1"> <thead> <tr> <th>Codice</th> <th>Descrizione</th> <th>Qtà</th> <th>UM</th> </tr> </thead> <tbody> <tr> <td>VI1220A1</td> <td>VITE AUTOFILETTA NTE 4.2X11 TCS+ MARUTE</td> <td>3</td> <td>PZ</td> </tr> <tr> <td>VM1762A0</td> <td>SUPPORTO LAMPADA INTERNO</td> <td>2</td> <td>PZ</td> </tr> <tr> <td>VM1794A0</td> <td>FASCETTA 430X4.8 PA66 NERA</td> <td>2</td> <td>PZ</td> </tr> <tr> <td>VM2007A0</td> <td>TASTO ARGENTO OPACO VELOCITA VENTOLA</td> <td>1</td> <td>PZ</td> </tr> <tr> <td>VM2009A0</td> <td>SUPPORTO ELLITTICO D16 ARGENTO</td> <td>3</td> <td>PZ</td> </tr> <tr> <td>VM2103A0</td> <td>PIASTRINA FERMAFASCE TTA</td> <td>2</td> <td>PZ</td> </tr> <tr> <td>VM2203A0</td> <td>CRUSCOTTO MANUALE CHEFLUX</td> <td>1</td> <td>PZ</td> </tr> </tbody> </table>	Codice	Descrizione	Qtà	UM	VI1220A1	VITE AUTOFILETTA NTE 4.2X11 TCS+ MARUTE	3	PZ	VM1762A0	SUPPORTO LAMPADA INTERNO	2	PZ	VM1794A0	FASCETTA 430X4.8 PA66 NERA	2	PZ	VM2007A0	TASTO ARGENTO OPACO VELOCITA VENTOLA	1	PZ	VM2009A0	SUPPORTO ELLITTICO D16 ARGENTO	3	PZ	VM2103A0	PIASTRINA FERMAFASCE TTA	2	PZ	VM2203A0	CRUSCOTTO MANUALE CHEFLUX	1	PZ
Codice	Descrizione	Qtà	UM																																		
VI1220A1	VITE AUTOFILETTA NTE 4.2X11 TCS+ MARUTE	3	PZ																																		
VM1762A0	SUPPORTO LAMPADA INTERNO	2	PZ																																		
VM1794A0	FASCETTA 430X4.8 PA66 NERA	2	PZ																																		
VM2007A0	TASTO ARGENTO OPACO VELOCITA VENTOLA	1	PZ																																		
VM2009A0	SUPPORTO ELLITTICO D16 ARGENTO	3	PZ																																		
VM2103A0	PIASTRINA FERMAFASCE TTA	2	PZ																																		
VM2203A0	CRUSCOTTO MANUALE CHEFLUX	1	PZ																																		
MN1113A	MANOPOLA UMIDITA CHEFLUX BAKERLUX		KMN1113A	KIT MANOPOLA UMIDITA CL BL	<table border="1"> <thead> <tr> <th>Codice</th> <th>Descrizione</th> <th>Qtà</th> <th>UM</th> </tr> </thead> <tbody> <tr> <td>MN1113A2</td> <td>MANOPOLA UMIDITA CHEFLUX BAKERLUX</td> <td>1</td> <td>PZ</td> </tr> <tr> <td>VM1224A0</td> <td>TUBOLARE TERMORETR 65MY 220MM 2 COLORI</td> <td>0.200</td> <td>M</td> </tr> </tbody> </table>	Codice	Descrizione	Qtà	UM	MN1113A2	MANOPOLA UMIDITA CHEFLUX BAKERLUX	1	PZ	VM1224A0	TUBOLARE TERMORETR 65MY 220MM 2 COLORI	0.200	M																				
Codice	Descrizione	Qtà	UM																																		
MN1113A2	MANOPOLA UMIDITA CHEFLUX BAKERLUX	1	PZ																																		
VM1224A0	TUBOLARE TERMORETR 65MY 220MM 2 COLORI	0.200	M																																		
TB2823A	TB1815A0-D8 ACQUA XV393 0,5M		TB2823A0	TB1815A0-D8 ACQUA XV393 0,5M																																	

COMPONENTE			RICAMBIO														
Codice	Descrizione	Immagine	Codice	Descrizione	Lista componenti												
VM2035A	SUPPORTO PER TUBO DI SCARICO		KVM2035A	KIT 2 PZ SUPPORTO PER TUBO DI SCARICO	<table border="1"> <thead> <tr> <th>Codice</th> <th>Descrizione</th> <th>Qtà</th> <th>UM</th> </tr> </thead> <tbody> <tr> <td>VM1224A0</td> <td>TUBOLARE TERMORETR 65MY 220MM 2 COLORI</td> <td>0.250</td> <td>M</td> </tr> <tr> <td>VM2035A0</td> <td>SUPPORTO PER TUBO DI SCARICO</td> <td>2</td> <td>PZ</td> </tr> </tbody> </table>	Codice	Descrizione	Qtà	UM	VM1224A0	TUBOLARE TERMORETR 65MY 220MM 2 COLORI	0.250	M	VM2035A0	SUPPORTO PER TUBO DI SCARICO	2	PZ
Codice	Descrizione	Qtà	UM														
VM1224A0	TUBOLARE TERMORETR 65MY 220MM 2 COLORI	0.250	M														
VM2035A0	SUPPORTO PER TUBO DI SCARICO	2	PZ														
VM1975A	STAFFA INFERIORE SOSTEGNO PORTA		KVM1975A	KIT STAFFA INFERIORE PORTA CL BL	<table border="1"> <thead> <tr> <th>Codice</th> <th>Descrizione</th> <th>Qtà</th> <th>UM</th> </tr> </thead> <tbody> <tr> <td>VM1224A0</td> <td>TUBOLARE TERMORETR 65MY 220MM 2 COLORI</td> <td>0.250</td> <td>M</td> </tr> <tr> <td>VM1975A0</td> <td>STAFFA INFERIORE SOSTEGNO PORTA</td> <td>1</td> <td>PZ</td> </tr> </tbody> </table>	Codice	Descrizione	Qtà	UM	VM1224A0	TUBOLARE TERMORETR 65MY 220MM 2 COLORI	0.250	M	VM1975A0	STAFFA INFERIORE SOSTEGNO PORTA	1	PZ
Codice	Descrizione	Qtà	UM														
VM1224A0	TUBOLARE TERMORETR 65MY 220MM 2 COLORI	0.250	M														
VM1975A0	STAFFA INFERIORE SOSTEGNO PORTA	1	PZ														
VM2028A	RONDELLA GOMMA 20X10X4		KVM2028A	KIT 5 PZ. RONDELLA GOMMA 20X10X4	<table border="1"> <thead> <tr> <th>Codice</th> <th>Descrizione</th> <th>Qtà</th> <th>UM</th> </tr> </thead> <tbody> <tr> <td>VM1224A0</td> <td>TUBOLARE TERMORETR 65MY 220MM 2 COLORI</td> <td>0.200</td> <td>M</td> </tr> <tr> <td>VM2028A0</td> <td>RONDELLA GOMMA 20X10X4</td> <td>5</td> <td>PZ</td> </tr> </tbody> </table>	Codice	Descrizione	Qtà	UM	VM1224A0	TUBOLARE TERMORETR 65MY 220MM 2 COLORI	0.200	M	VM2028A0	RONDELLA GOMMA 20X10X4	5	PZ
Codice	Descrizione	Qtà	UM														
VM1224A0	TUBOLARE TERMORETR 65MY 220MM 2 COLORI	0.200	M														
VM2028A0	RONDELLA GOMMA 20X10X4	5	PZ														

ASM4081A/0.D00 - Porta



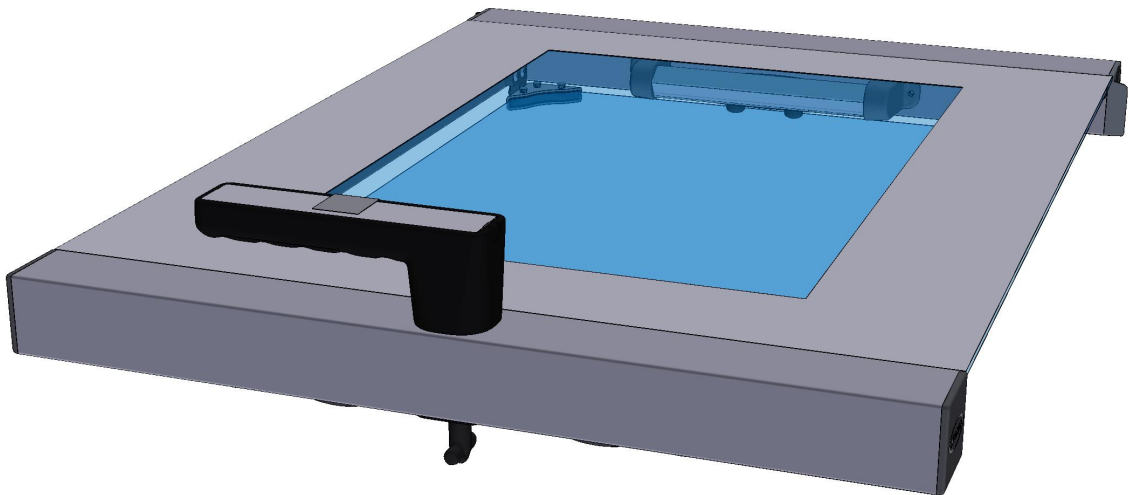

FRONTE

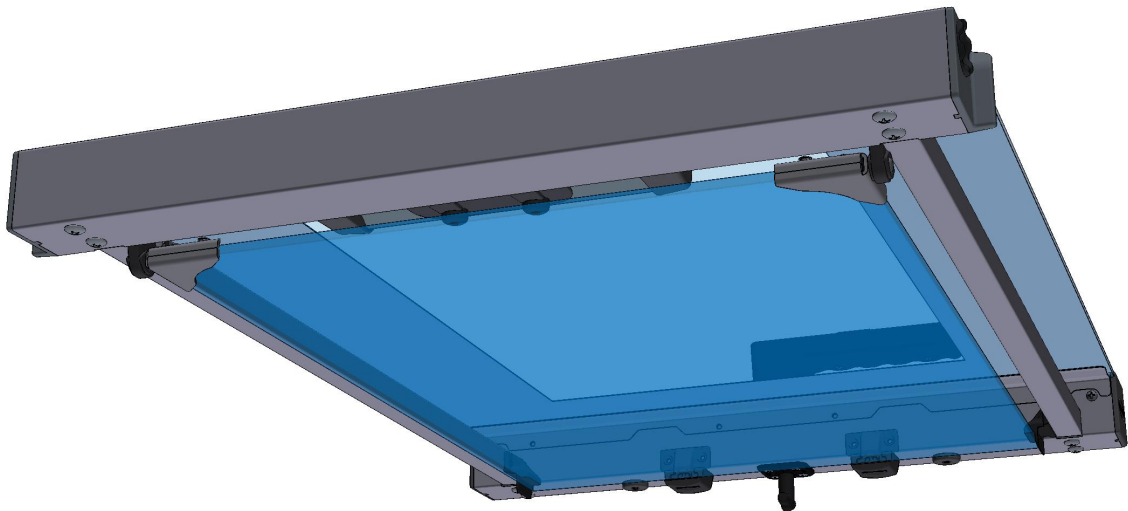

ASM4081A/0.D00 - Porta

RETRO





COMPONENTE			RICAMBIO																										
Codice	Descrizione	Immagine	Codice	Descrizione	Lista componenti																								
VM1630A	TAPPO PREMI VETRO INTERNO		KVM1630A	KIT 10 PZ TAPPO PREMI VETRO INTERNO	<table border="1"> <thead> <tr> <th>Codice</th> <th>Descrizione</th> <th>Qtà</th> <th>UM</th> </tr> </thead> <tbody> <tr> <td>VM1224A0</td> <td>TUBOLARE TERMORETR 65MY 220MM 2 COLORI</td> <td>0.200</td> <td>M</td> </tr> <tr> <td>VM1630A0</td> <td>TAPPO PREMI VETRO INTERNO</td> <td>10</td> <td>PZ</td> </tr> <tr> <td>VM1630A1</td> <td>TAPPO PREMI VETRO INTERNO</td> <td>10</td> <td>PZ</td> </tr> </tbody> </table>	Codice	Descrizione	Qtà	UM	VM1224A0	TUBOLARE TERMORETR 65MY 220MM 2 COLORI	0.200	M	VM1630A0	TAPPO PREMI VETRO INTERNO	10	PZ	VM1630A1	TAPPO PREMI VETRO INTERNO	10	PZ								
Codice	Descrizione	Qtà	UM																										
VM1224A0	TUBOLARE TERMORETR 65MY 220MM 2 COLORI	0.200	M																										
VM1630A0	TAPPO PREMI VETRO INTERNO	10	PZ																										
VM1630A1	TAPPO PREMI VETRO INTERNO	10	PZ																										
VM1591A	STAFFA SPINGIVETRO INTERNO XVC1004		KVM1591A	KIT SPINGIVETRO INTERNO H35 S.5E	<table border="1"> <thead> <tr> <th>Codice</th> <th>Descrizione</th> <th>Qtà</th> <th>UM</th> </tr> </thead> <tbody> <tr> <td>VI1220A1</td> <td>VITE AUTOFILETTA NTE 4.2X11 TCS+ MARUTE</td> <td>2</td> <td>PZ</td> </tr> <tr> <td>VM1224A0</td> <td>TUBOLARE TERMORETR 65MY 220MM 2 COLORI</td> <td>0.200</td> <td>M</td> </tr> <tr> <td>VM1591A0</td> <td>STAFFA SPINGIVETRO INTERNO XVC1004</td> <td>1</td> <td>PZ</td> </tr> <tr> <td>VM1630A0</td> <td>TAPPO PREMI VETRO INTERNO</td> <td>2</td> <td>PZ</td> </tr> <tr> <td>VM1630A1</td> <td>TAPPO PREMI VETRO INTERNO</td> <td>2</td> <td>PZ</td> </tr> </tbody> </table>	Codice	Descrizione	Qtà	UM	VI1220A1	VITE AUTOFILETTA NTE 4.2X11 TCS+ MARUTE	2	PZ	VM1224A0	TUBOLARE TERMORETR 65MY 220MM 2 COLORI	0.200	M	VM1591A0	STAFFA SPINGIVETRO INTERNO XVC1004	1	PZ	VM1630A0	TAPPO PREMI VETRO INTERNO	2	PZ	VM1630A1	TAPPO PREMI VETRO INTERNO	2	PZ
Codice	Descrizione	Qtà	UM																										
VI1220A1	VITE AUTOFILETTA NTE 4.2X11 TCS+ MARUTE	2	PZ																										
VM1224A0	TUBOLARE TERMORETR 65MY 220MM 2 COLORI	0.200	M																										
VM1591A0	STAFFA SPINGIVETRO INTERNO XVC1004	1	PZ																										
VM1630A0	TAPPO PREMI VETRO INTERNO	2	PZ																										
VM1630A1	TAPPO PREMI VETRO INTERNO	2	PZ																										
VM1170B	TAPPO FULCRO SUP. PORTA XVC204/304/504/7		KVM1170B	KIT TAPPO FULCRO SUP PORTA XVC204/304	<table border="1"> <thead> <tr> <th>Codice</th> <th>Descrizione</th> <th>Qtà</th> <th>UM</th> </tr> </thead> <tbody> <tr> <td>VM1170B0</td> <td>TAPPO FULCRO SUP. PORTA XVC204/304/504/7</td> <td>2</td> <td>PZ</td> </tr> <tr> <td>VM1224A0</td> <td>TUBOLARE TERMORETR 65MY 220MM 2 COLORI</td> <td>0.250</td> <td>M</td> </tr> </tbody> </table>	Codice	Descrizione	Qtà	UM	VM1170B0	TAPPO FULCRO SUP. PORTA XVC204/304/504/7	2	PZ	VM1224A0	TUBOLARE TERMORETR 65MY 220MM 2 COLORI	0.250	M												
Codice	Descrizione	Qtà	UM																										
VM1170B0	TAPPO FULCRO SUP. PORTA XVC204/304/504/7	2	PZ																										
VM1224A0	TUBOLARE TERMORETR 65MY 220MM 2 COLORI	0.250	M																										
VM1511A	BOCCOLA LISCIA LUNGA PORTA CHEFFTOP		KVM1511A	KIT BOCCOLA VM1511A0 5PZ	<table border="1"> <thead> <tr> <th>Codice</th> <th>Descrizione</th> <th>Qtà</th> <th>UM</th> </tr> </thead> <tbody> <tr> <td>VM1224A0</td> <td>TUBOLARE TERMORETR 65MY 220MM 2 COLORI</td> <td>0.200</td> <td>M</td> </tr> <tr> <td>VM1511A0</td> <td>BOCCOLA LISCIA LUNGA PORTA CHEFFTOP</td> <td>5</td> <td>PZ</td> </tr> </tbody> </table>	Codice	Descrizione	Qtà	UM	VM1224A0	TUBOLARE TERMORETR 65MY 220MM 2 COLORI	0.200	M	VM1511A0	BOCCOLA LISCIA LUNGA PORTA CHEFFTOP	5	PZ												
Codice	Descrizione	Qtà	UM																										
VM1224A0	TUBOLARE TERMORETR 65MY 220MM 2 COLORI	0.200	M																										
VM1511A0	BOCCOLA LISCIA LUNGA PORTA CHEFFTOP	5	PZ																										

COMPONENTE			RICAMBIO														
Codice	Descrizione	Immagine	Codice	Descrizione	Lista componenti												
VM1171B	TAPPO FULCRO INF. PORTA XVC204/304/504/7		KVM1171B	KIT TAPPO FULCRO INF.PORTA XVC204/304/5	<table border="1"> <thead> <tr> <th>Codice</th> <th>Descrizione</th> <th>Qtà</th> <th>UM</th> </tr> </thead> <tbody> <tr> <td>VM1171B0</td> <td>TAPPO FULCRO INF. PORTA XVC204/304/504/7</td> <td>2</td> <td>PZ</td> </tr> <tr> <td>VM1224A0</td> <td>TUBOLARE TERMORETR 65MY 220MM 2 COLORI</td> <td>0.250</td> <td>M</td> </tr> </tbody> </table>	Codice	Descrizione	Qtà	UM	VM1171B0	TAPPO FULCRO INF. PORTA XVC204/304/504/7	2	PZ	VM1224A0	TUBOLARE TERMORETR 65MY 220MM 2 COLORI	0.250	M
Codice	Descrizione	Qtà	UM														
VM1171B0	TAPPO FULCRO INF. PORTA XVC204/304/504/7	2	PZ														
VM1224A0	TUBOLARE TERMORETR 65MY 220MM 2 COLORI	0.250	M														
VM1510A	BOCCOLA SCANALATA LUNGA PORTA XBC/XVC		KVM1510A	KIT BOCCOLA VM1510A0 5 PZ	<table border="1"> <thead> <tr> <th>Codice</th> <th>Descrizione</th> <th>Qtà</th> <th>UM</th> </tr> </thead> <tbody> <tr> <td>VM1224A0</td> <td>TUBOLARE TERMORETR 65MY 220MM 2 COLORI</td> <td>0.150</td> <td>M</td> </tr> <tr> <td>VM1510A0</td> <td>BOCCOLA SCANALATA LUNGA PORTA XBC/XVC</td> <td>5</td> <td>PZ</td> </tr> </tbody> </table>	Codice	Descrizione	Qtà	UM	VM1224A0	TUBOLARE TERMORETR 65MY 220MM 2 COLORI	0.150	M	VM1510A0	BOCCOLA SCANALATA LUNGA PORTA XBC/XVC	5	PZ
Codice	Descrizione	Qtà	UM														
VM1224A0	TUBOLARE TERMORETR 65MY 220MM 2 COLORI	0.150	M														
VM1510A0	BOCCOLA SCANALATA LUNGA PORTA XBC/XVC	5	PZ														
VM1976A	TAPPO ESTETICO COLONNINA PORTA CL BL		KVM1976A	KIT TAPPO ESTETICO COLONNINA PORTA CL BL	<table border="1"> <thead> <tr> <th>Codice</th> <th>Descrizione</th> <th>Qtà</th> <th>UM</th> </tr> </thead> <tbody> <tr> <td>VM1224A0</td> <td>TUBOLARE TERMORETR 65MY 220MM 2 COLORI</td> <td>0.200</td> <td>M</td> </tr> <tr> <td>VM1976A0</td> <td>TAPPO ESTETICO COLONNINA PORTA CL BL</td> <td>1</td> <td>PZ</td> </tr> </tbody> </table>	Codice	Descrizione	Qtà	UM	VM1224A0	TUBOLARE TERMORETR 65MY 220MM 2 COLORI	0.200	M	VM1976A0	TAPPO ESTETICO COLONNINA PORTA CL BL	1	PZ
Codice	Descrizione	Qtà	UM														
VM1224A0	TUBOLARE TERMORETR 65MY 220MM 2 COLORI	0.200	M														
VM1976A0	TAPPO ESTETICO COLONNINA PORTA CL BL	1	PZ														
VM1680A	CERNIERA APERTURA VETRO INTERNO		KVM1680A	KIT 2 PZ SOSTEGNO CERNIERA VETRO INT	<table border="1"> <thead> <tr> <th>Codice</th> <th>Descrizione</th> <th>Qtà</th> <th>UM</th> </tr> </thead> <tbody> <tr> <td>VM1224A0</td> <td>TUBOLARE TERMORETR 65MY 220MM 2 COLORI</td> <td>0.200</td> <td>M</td> </tr> <tr> <td>VM1680A0</td> <td>CERNIERA APERTURA VETRO INTERNO</td> <td>2</td> <td>PZ</td> </tr> </tbody> </table>	Codice	Descrizione	Qtà	UM	VM1224A0	TUBOLARE TERMORETR 65MY 220MM 2 COLORI	0.200	M	VM1680A0	CERNIERA APERTURA VETRO INTERNO	2	PZ
Codice	Descrizione	Qtà	UM														
VM1224A0	TUBOLARE TERMORETR 65MY 220MM 2 COLORI	0.200	M														
VM1680A0	CERNIERA APERTURA VETRO INTERNO	2	PZ														
VM2043A	SUPPORTO VETRO SUP - INF		KVM2043A	KIT 2 PZ SUPPORTO VETRO SUP - INF	<table border="1"> <thead> <tr> <th>Codice</th> <th>Descrizione</th> <th>Qtà</th> <th>UM</th> </tr> </thead> <tbody> <tr> <td>VM1224A0</td> <td>TUBOLARE TERMORETR 65MY 220MM 2 COLORI</td> <td>0.150</td> <td>M</td> </tr> <tr> <td>VM2043A0</td> <td>SUPPORTO VETRO SUP - INF</td> <td>2</td> <td>PZ</td> </tr> </tbody> </table>	Codice	Descrizione	Qtà	UM	VM1224A0	TUBOLARE TERMORETR 65MY 220MM 2 COLORI	0.150	M	VM2043A0	SUPPORTO VETRO SUP - INF	2	PZ
Codice	Descrizione	Qtà	UM														
VM1224A0	TUBOLARE TERMORETR 65MY 220MM 2 COLORI	0.150	M														
VM2043A0	SUPPORTO VETRO SUP - INF	2	PZ														

COMPONENTE			RICAMBIO																						
Codice	Descrizione	Immagine	Codice	Descrizione	Lista componenti																				
VM2008A	DISTANZIALE PER MICROPORTA MEC		KVM2008A	KIT DISTANZIALE PER MICROPORTA MECC	<table border="1"> <thead> <tr> <th>Codice</th> <th>Descrizione</th> <th>Qtà</th> <th>UM</th> </tr> </thead> <tbody> <tr> <td>VM1224A0</td> <td>TUBOLARE TERMORETR 65MY 220MM 2 COLORI</td> <td>0.200</td> <td>M</td> </tr> <tr> <td>VM2008A0</td> <td>DISTANZIALE PER MICROPORTA MECC</td> <td>2</td> <td>PZ</td> </tr> </tbody> </table>	Codice	Descrizione	Qtà	UM	VM1224A0	TUBOLARE TERMORETR 65MY 220MM 2 COLORI	0.200	M	VM2008A0	DISTANZIALE PER MICROPORTA MECC	2	PZ								
Codice	Descrizione	Qtà	UM																						
VM1224A0	TUBOLARE TERMORETR 65MY 220MM 2 COLORI	0.200	M																						
VM2008A0	DISTANZIALE PER MICROPORTA MECC	2	PZ																						
VE1030A	CALAMITA D=22,9MM PER MICROPORTA		KVE1030A	KIT MAGNETE MICROPORTA 2 PZ	<table border="1"> <thead> <tr> <th>Codice</th> <th>Descrizione</th> <th>Qtà</th> <th>UM</th> </tr> </thead> <tbody> <tr> <td>VE1030A1</td> <td>CALAMITA D=22,9MM PER MICROPORTA</td> <td>2</td> <td>PZ</td> </tr> <tr> <td>VM1224A0</td> <td>TUBOLARE TERMORETR 65MY 220MM 2 COLORI</td> <td>0.150</td> <td>M</td> </tr> </tbody> </table>	Codice	Descrizione	Qtà	UM	VE1030A1	CALAMITA D=22,9MM PER MICROPORTA	2	PZ	VM1224A0	TUBOLARE TERMORETR 65MY 220MM 2 COLORI	0.150	M								
Codice	Descrizione	Qtà	UM																						
VE1030A1	CALAMITA D=22,9MM PER MICROPORTA	2	PZ																						
VM1224A0	TUBOLARE TERMORETR 65MY 220MM 2 COLORI	0.150	M																						
			KVE1020A	KIT MICROPORTA	<table border="1"> <thead> <tr> <th>Codice</th> <th>Descrizione</th> <th>Qtà</th> <th>UM</th> </tr> </thead> <tbody> <tr> <td>VE1020A2</td> <td>MICROINTERRUTTORE PORTA MAGNETICO</td> <td>1</td> <td>PZ</td> </tr> <tr> <td>VE1030A1</td> <td>CALAMITA D=22,9MM PER MICROPORTA</td> <td>4</td> <td>PZ</td> </tr> <tr> <td>VM1224A0</td> <td>TUBOLARE TERMORETR 65MY 220MM 2 COLORI</td> <td>0.250</td> <td>M</td> </tr> </tbody> </table>	Codice	Descrizione	Qtà	UM	VE1020A2	MICROINTERRUTTORE PORTA MAGNETICO	1	PZ	VE1030A1	CALAMITA D=22,9MM PER MICROPORTA	4	PZ	VM1224A0	TUBOLARE TERMORETR 65MY 220MM 2 COLORI	0.250	M				
Codice	Descrizione	Qtà	UM																						
VE1020A2	MICROINTERRUTTORE PORTA MAGNETICO	1	PZ																						
VE1030A1	CALAMITA D=22,9MM PER MICROPORTA	4	PZ																						
VM1224A0	TUBOLARE TERMORETR 65MY 220MM 2 COLORI	0.250	M																						
VM2042A	ASSIEME CHIUSURA VETRO INTERNO LAT		KVM2042A	KIT CHIUSURA A MOLLA VETRO INT	<table border="1"> <thead> <tr> <th>Codice</th> <th>Descrizione</th> <th>Qtà</th> <th>UM</th> </tr> </thead> <tbody> <tr> <td>RC1200A0</td> <td>MOLLA A COMPRESSIONE DE4 DF0.5 H24</td> <td>2</td> <td>PZ</td> </tr> <tr> <td>VI1220A1</td> <td>VITE AUTOFILETTATE NTE 4.2X11 TCS+ MARUTE</td> <td>2</td> <td>PZ</td> </tr> <tr> <td>VM1224A0</td> <td>TUBOLARE TERMORETR 65MY 220MM 2 COLORI</td> <td>0.200</td> <td>M</td> </tr> <tr> <td>VM2042A0</td> <td>ASSIEME CHIUSURA VETRO INTERNO LAT</td> <td>1</td> <td>PZ</td> </tr> </tbody> </table>	Codice	Descrizione	Qtà	UM	RC1200A0	MOLLA A COMPRESSIONE DE4 DF0.5 H24	2	PZ	VI1220A1	VITE AUTOFILETTATE NTE 4.2X11 TCS+ MARUTE	2	PZ	VM1224A0	TUBOLARE TERMORETR 65MY 220MM 2 COLORI	0.200	M	VM2042A0	ASSIEME CHIUSURA VETRO INTERNO LAT	1	PZ
Codice	Descrizione	Qtà	UM																						
RC1200A0	MOLLA A COMPRESSIONE DE4 DF0.5 H24	2	PZ																						
VI1220A1	VITE AUTOFILETTATE NTE 4.2X11 TCS+ MARUTE	2	PZ																						
VM1224A0	TUBOLARE TERMORETR 65MY 220MM 2 COLORI	0.200	M																						
VM2042A0	ASSIEME CHIUSURA VETRO INTERNO LAT	1	PZ																						

COMPONENTE			RICAMBIO																																										
Codice	Descrizione	Immagine	Codice	Descrizione	Lista componenti																																								
VM1620A	SUPPORTO INF BARRA LED		KLP1044A	KIT BARRA ILLUMINAZIONE LED LUX	<table border="1"> <thead> <tr> <th>Codice</th> <th>Descrizione</th> <th>Qtà</th> <th>UM</th> </tr> </thead> <tbody> <tr> <td>CE1455A0</td> <td>TERMINALE A PUNTALE</td> <td>2</td> <td>PZ</td> </tr> <tr> <td>CE1730A0</td> <td>CAVO PVC NP 2 X AWG22 STYLE 2095</td> <td>4.500</td> <td>M</td> </tr> <tr> <td>CE1735A0</td> <td>TERMINALE MINIFIT FEMMINA</td> <td>2</td> <td>PZ</td> </tr> <tr> <td>CE1740A0</td> <td>TERMINALE MINIFIT MASCHIO</td> <td>4</td> <td>PZ</td> </tr> <tr> <td>CE1745A0</td> <td>CONNETTORE MINIFIT FEMMINA 2 VI</td> <td>2</td> <td>PZ</td> </tr> <tr> <td>CE1750A0</td> <td>CONNETTORE MINIFIT MASCHIO 3 VI</td> <td>1</td> <td>PZ</td> </tr> <tr> <td>LP1044A0</td> <td>BARRA ILLUMINAZION E LED LUX</td> <td>1</td> <td>PZ</td> </tr> <tr> <td>VM1620A0</td> <td>SUPPORTO INF BARRA LE</td> <td>1</td> <td>PZ</td> </tr> <tr> <td>VM1621A0</td> <td>SUPPORTO SUP BARRA LED</td> <td>1</td> <td>PZ</td> </tr> </tbody> </table>	Codice	Descrizione	Qtà	UM	CE1455A0	TERMINALE A PUNTALE	2	PZ	CE1730A0	CAVO PVC NP 2 X AWG22 STYLE 2095	4.500	M	CE1735A0	TERMINALE MINIFIT FEMMINA	2	PZ	CE1740A0	TERMINALE MINIFIT MASCHIO	4	PZ	CE1745A0	CONNETTORE MINIFIT FEMMINA 2 VI	2	PZ	CE1750A0	CONNETTORE MINIFIT MASCHIO 3 VI	1	PZ	LP1044A0	BARRA ILLUMINAZION E LED LUX	1	PZ	VM1620A0	SUPPORTO INF BARRA LE	1	PZ	VM1621A0	SUPPORTO SUP BARRA LED	1	PZ
			Codice	Descrizione	Qtà	UM																																							
CE1455A0	TERMINALE A PUNTALE	2	PZ																																										
CE1730A0	CAVO PVC NP 2 X AWG22 STYLE 2095	4.500	M																																										
CE1735A0	TERMINALE MINIFIT FEMMINA	2	PZ																																										
CE1740A0	TERMINALE MINIFIT MASCHIO	4	PZ																																										
CE1745A0	CONNETTORE MINIFIT FEMMINA 2 VI	2	PZ																																										
CE1750A0	CONNETTORE MINIFIT MASCHIO 3 VI	1	PZ																																										
LP1044A0	BARRA ILLUMINAZION E LED LUX	1	PZ																																										
VM1620A0	SUPPORTO INF BARRA LE	1	PZ																																										
VM1621A0	SUPPORTO SUP BARRA LED	1	PZ																																										
KLP1007A	KIT BARRA LED L200	<table border="1"> <thead> <tr> <th>Codice</th> <th>Descrizione</th> <th>Qtà</th> <th>UM</th> </tr> </thead> <tbody> <tr> <td>CE1455A0</td> <td>TERMINALE A PUNTALE</td> <td>2</td> <td>PZ</td> </tr> <tr> <td>CE1730A0</td> <td>CAVO PVC NP 2 X AWG22 STYLE 2095</td> <td>4.500</td> <td>M</td> </tr> <tr> <td>CE1735A0</td> <td>TERMINALE MINIFIT FEMMINA</td> <td>2</td> <td>PZ</td> </tr> <tr> <td>CE1740A0</td> <td>TERMINALE MINIFIT MASCHIO</td> <td>4</td> <td>PZ</td> </tr> <tr> <td>CE1745A0</td> <td>CONNETTORE MINIFIT FEMMINA 2 VI</td> <td>2</td> <td>PZ</td> </tr> <tr> <td>CE1750A0</td> <td>CONNETTORE MINIFIT MASCHIO 3 VI</td> <td>1</td> <td>PZ</td> </tr> <tr> <td>LP1007A0</td> <td>BARRA ILLUMINAZION E LED L200</td> <td>1</td> <td>PZ</td> </tr> <tr> <td>VM1620A0</td> <td>SUPPORTO INF BARRA LE</td> <td>1</td> <td>PZ</td> </tr> <tr> <td>VM1621A0</td> <td>SUPPORTO SUP BARRA LED</td> <td>1</td> <td>PZ</td> </tr> </tbody> </table>	Codice	Descrizione	Qtà	UM	CE1455A0	TERMINALE A PUNTALE	2	PZ	CE1730A0	CAVO PVC NP 2 X AWG22 STYLE 2095	4.500	M	CE1735A0	TERMINALE MINIFIT FEMMINA	2	PZ	CE1740A0	TERMINALE MINIFIT MASCHIO	4	PZ	CE1745A0	CONNETTORE MINIFIT FEMMINA 2 VI	2	PZ	CE1750A0	CONNETTORE MINIFIT MASCHIO 3 VI	1	PZ	LP1007A0	BARRA ILLUMINAZION E LED L200	1	PZ	VM1620A0	SUPPORTO INF BARRA LE	1	PZ	VM1621A0	SUPPORTO SUP BARRA LED	1	PZ			
Codice	Descrizione	Qtà	UM																																										
CE1455A0	TERMINALE A PUNTALE	2	PZ																																										
CE1730A0	CAVO PVC NP 2 X AWG22 STYLE 2095	4.500	M																																										
CE1735A0	TERMINALE MINIFIT FEMMINA	2	PZ																																										
CE1740A0	TERMINALE MINIFIT MASCHIO	4	PZ																																										
CE1745A0	CONNETTORE MINIFIT FEMMINA 2 VI	2	PZ																																										
CE1750A0	CONNETTORE MINIFIT MASCHIO 3 VI	1	PZ																																										
LP1007A0	BARRA ILLUMINAZION E LED L200	1	PZ																																										
VM1620A0	SUPPORTO INF BARRA LE	1	PZ																																										
VM1621A0	SUPPORTO SUP BARRA LED	1	PZ																																										

COMPONENTE			RICAMBIO																																														
<i>Codice</i>	<i>Descrizione</i>	<i>Immagine</i>	<i>Codice</i>	<i>Descrizione</i>	<i>Lista componenti</i>																																												
VM1620A	SUPPORTO INF BARRA LED		KLP1004B	KIT RICAMBIO BARRA LED L1000	<table border="1"> <thead> <tr> <th><i>Codice</i></th> <th><i>Descrizione</i></th> <th><i>Qtà</i></th> <th><i>UM</i></th> </tr> </thead> <tbody> <tr> <td>CE1730A0</td> <td>CAVO PVC NP 2 X AWG22 STYLE 2095</td> <td>1</td> <td>M</td> </tr> <tr> <td>CE1735A0</td> <td>TERMINALE MINIFIT FEMMINA</td> <td>2</td> <td>PZ</td> </tr> <tr> <td>CE1740A0</td> <td>TERMINALE MINIFIT MASCHIO</td> <td>2</td> <td>PZ</td> </tr> <tr> <td>CE1745A0</td> <td>CONNETTORE MINIFIT FEMMINA 2 VI</td> <td>1</td> <td>PZ</td> </tr> <tr> <td>CE1750A0</td> <td>CONNETTORE MINIFIT MASCHIO 3 VI</td> <td>1</td> <td>PZ</td> </tr> <tr> <td>IP1385A1</td> <td>IMB POL ANGOLARE 110X80X2000 D30</td> <td>2.200</td> <td>M</td> </tr> <tr> <td>LP1004B0</td> <td>BARRA ILLUMINAZION E LED L1000</td> <td>1</td> <td>PZ</td> </tr> <tr> <td>VM1059A1</td> <td>FILM TERMORETRA IBILE H800</td> <td>1.300</td> <td>M</td> </tr> <tr> <td>VM1620A0</td> <td>SUPPORTO INF BARRA LE</td> <td>1</td> <td>PZ</td> </tr> <tr> <td>VM1621A0</td> <td>SUPPORTO SUP BARRA LED</td> <td>1</td> <td>PZ</td> </tr> </tbody> </table>	<i>Codice</i>	<i>Descrizione</i>	<i>Qtà</i>	<i>UM</i>	CE1730A0	CAVO PVC NP 2 X AWG22 STYLE 2095	1	M	CE1735A0	TERMINALE MINIFIT FEMMINA	2	PZ	CE1740A0	TERMINALE MINIFIT MASCHIO	2	PZ	CE1745A0	CONNETTORE MINIFIT FEMMINA 2 VI	1	PZ	CE1750A0	CONNETTORE MINIFIT MASCHIO 3 VI	1	PZ	IP1385A1	IMB POL ANGOLARE 110X80X2000 D30	2.200	M	LP1004B0	BARRA ILLUMINAZION E LED L1000	1	PZ	VM1059A1	FILM TERMORETRA IBILE H800	1.300	M	VM1620A0	SUPPORTO INF BARRA LE	1	PZ	VM1621A0	SUPPORTO SUP BARRA LED	1	PZ
			<i>Codice</i>	<i>Descrizione</i>	<i>Qtà</i>	<i>UM</i>																																											
CE1730A0	CAVO PVC NP 2 X AWG22 STYLE 2095	1	M																																														
CE1735A0	TERMINALE MINIFIT FEMMINA	2	PZ																																														
CE1740A0	TERMINALE MINIFIT MASCHIO	2	PZ																																														
CE1745A0	CONNETTORE MINIFIT FEMMINA 2 VI	1	PZ																																														
CE1750A0	CONNETTORE MINIFIT MASCHIO 3 VI	1	PZ																																														
IP1385A1	IMB POL ANGOLARE 110X80X2000 D30	2.200	M																																														
LP1004B0	BARRA ILLUMINAZION E LED L1000	1	PZ																																														
VM1059A1	FILM TERMORETRA IBILE H800	1.300	M																																														
VM1620A0	SUPPORTO INF BARRA LE	1	PZ																																														
VM1621A0	SUPPORTO SUP BARRA LED	1	PZ																																														
KLP1003B	KIT RICAMBIO BARRA LED L600	<table border="1"> <thead> <tr> <th><i>Codice</i></th> <th><i>Descrizione</i></th> <th><i>Qtà</i></th> <th><i>UM</i></th> </tr> </thead> <tbody> <tr> <td>CE1730A0</td> <td>CAVO PVC NP 2 X AWG22 STYLE 2095</td> <td>1</td> <td>M</td> </tr> <tr> <td>CE1735A0</td> <td>TERMINALE MINIFIT FEMMINA</td> <td>2</td> <td>PZ</td> </tr> <tr> <td>CE1740A0</td> <td>TERMINALE MINIFIT MASCHIO</td> <td>2</td> <td>PZ</td> </tr> <tr> <td>CE1745A0</td> <td>CONNETTORE MINIFIT FEMMINA 2 VI</td> <td>1</td> <td>PZ</td> </tr> <tr> <td>CE1750A0</td> <td>CONNETTORE MINIFIT MASCHIO 3 VI</td> <td>1</td> <td>PZ</td> </tr> <tr> <td>LP1003B0</td> <td>BARRA ILLUMINAZION E LED L600</td> <td>1</td> <td>PZ</td> </tr> <tr> <td>VM1620A0</td> <td>SUPPORTO INF BARRA LE</td> <td>1</td> <td>PZ</td> </tr> <tr> <td>VM1621A0</td> <td>SUPPORTO SUP BARRA LED</td> <td>1</td> <td>PZ</td> </tr> </tbody> </table>	<i>Codice</i>	<i>Descrizione</i>	<i>Qtà</i>	<i>UM</i>	CE1730A0	CAVO PVC NP 2 X AWG22 STYLE 2095	1	M	CE1735A0	TERMINALE MINIFIT FEMMINA	2	PZ	CE1740A0	TERMINALE MINIFIT MASCHIO	2	PZ	CE1745A0	CONNETTORE MINIFIT FEMMINA 2 VI	1	PZ	CE1750A0	CONNETTORE MINIFIT MASCHIO 3 VI	1	PZ	LP1003B0	BARRA ILLUMINAZION E LED L600	1	PZ	VM1620A0	SUPPORTO INF BARRA LE	1	PZ	VM1621A0	SUPPORTO SUP BARRA LED	1	PZ											
<i>Codice</i>	<i>Descrizione</i>	<i>Qtà</i>	<i>UM</i>																																														
CE1730A0	CAVO PVC NP 2 X AWG22 STYLE 2095	1	M																																														
CE1735A0	TERMINALE MINIFIT FEMMINA	2	PZ																																														
CE1740A0	TERMINALE MINIFIT MASCHIO	2	PZ																																														
CE1745A0	CONNETTORE MINIFIT FEMMINA 2 VI	1	PZ																																														
CE1750A0	CONNETTORE MINIFIT MASCHIO 3 VI	1	PZ																																														
LP1003B0	BARRA ILLUMINAZION E LED L600	1	PZ																																														
VM1620A0	SUPPORTO INF BARRA LE	1	PZ																																														
VM1621A0	SUPPORTO SUP BARRA LED	1	PZ																																														



COMPONENTE			RICAMBIO																																							
Codice	Descrizione	Immagine	Codice	Descrizione	Lista componenti																																					
VM1620A	SUPPORTO INF BARRA LED		KLP1003B	KIT RICAMBIO BARRA LED L600	<table border="1"> <thead> <tr> <th>Codice</th> <th>Descrizione</th> <th>Qtà</th> <th>UM</th> </tr> </thead> <tbody> <tr> <td>VM1794A0</td> <td>FASCETTA 430X4.8 PA66 NERA</td> <td>2</td> <td>PZ</td> </tr> <tr> <td>VM2103A0</td> <td>PIASTRINA FERMAFASCE TTA</td> <td>2</td> <td>PZ</td> </tr> </tbody> </table>	Codice	Descrizione	Qtà	UM	VM1794A0	FASCETTA 430X4.8 PA66 NERA	2	PZ	VM2103A0	PIASTRINA FERMAFASCE TTA	2	PZ																									
			Codice	Descrizione	Qtà	UM																																				
			VM1794A0	FASCETTA 430X4.8 PA66 NERA	2	PZ																																				
VM2103A0	PIASTRINA FERMAFASCE TTA	2	PZ																																							
KLP1002B	KIT RICAMBIO BARRA LED L400	<table border="1"> <thead> <tr> <th>Codice</th> <th>Descrizione</th> <th>Qtà</th> <th>UM</th> </tr> </thead> <tbody> <tr> <td>CE1455A0</td> <td>TERMINALE A PUNTALE</td> <td>2</td> <td>PZ</td> </tr> <tr> <td>CE1730A0</td> <td>CAVO PVC NP 2 X AWG22 STYLE 2095</td> <td>4.500</td> <td>M</td> </tr> <tr> <td>CE1735A0</td> <td>TERMINALE MINIFIT FEMMINA</td> <td>2</td> <td>PZ</td> </tr> <tr> <td>CE1740A0</td> <td>TERMINALE MINIFIT MASCIO</td> <td>4</td> <td>PZ</td> </tr> <tr> <td>CE1745A0</td> <td>CONNETTORE MINIFIT FEMMINA 2 VI</td> <td>2</td> <td>PZ</td> </tr> <tr> <td>CE1750A0</td> <td>CONNETTORE MINIFIT MASCIO 3 VI</td> <td>1</td> <td>PZ</td> </tr> <tr> <td>LP1002B0</td> <td>BARRA ILLUMINAZION E LED L400</td> <td>1</td> <td>PZ</td> </tr> <tr> <td>VM1620A0</td> <td>SUPPORTO INF BARRA LE</td> <td>1</td> <td>PZ</td> </tr> <tr> <td>VM1621A0</td> <td>SUPPORTO SUP BARRA LED</td> <td>1</td> <td>PZ</td> </tr> </tbody> </table>	Codice	Descrizione	Qtà	UM	CE1455A0	TERMINALE A PUNTALE	2	PZ	CE1730A0	CAVO PVC NP 2 X AWG22 STYLE 2095	4.500	M	CE1735A0	TERMINALE MINIFIT FEMMINA	2	PZ	CE1740A0	TERMINALE MINIFIT MASCIO	4	PZ	CE1745A0	CONNETTORE MINIFIT FEMMINA 2 VI	2	PZ	CE1750A0	CONNETTORE MINIFIT MASCIO 3 VI	1	PZ	LP1002B0	BARRA ILLUMINAZION E LED L400	1	PZ	VM1620A0	SUPPORTO INF BARRA LE	1	PZ	VM1621A0	SUPPORTO SUP BARRA LED	1	PZ
Codice	Descrizione	Qtà	UM																																							
CE1455A0	TERMINALE A PUNTALE	2	PZ																																							
CE1730A0	CAVO PVC NP 2 X AWG22 STYLE 2095	4.500	M																																							
CE1735A0	TERMINALE MINIFIT FEMMINA	2	PZ																																							
CE1740A0	TERMINALE MINIFIT MASCIO	4	PZ																																							
CE1745A0	CONNETTORE MINIFIT FEMMINA 2 VI	2	PZ																																							
CE1750A0	CONNETTORE MINIFIT MASCIO 3 VI	1	PZ																																							
LP1002B0	BARRA ILLUMINAZION E LED L400	1	PZ																																							
VM1620A0	SUPPORTO INF BARRA LE	1	PZ																																							
VM1621A0	SUPPORTO SUP BARRA LED	1	PZ																																							
KLP1001B	KIT RICAMBIO BARRA LED L300	<table border="1"> <thead> <tr> <th>Codice</th> <th>Descrizione</th> <th>Qtà</th> <th>UM</th> </tr> </thead> <tbody> <tr> <td>CE1455A0</td> <td>TERMINALE A PUNTALE</td> <td>2</td> <td>PZ</td> </tr> <tr> <td>CE1730A0</td> <td>CAVO PVC NP 2 X AWG22 STYLE 2095</td> <td>4.500</td> <td>M</td> </tr> <tr> <td>CE1735A0</td> <td>TERMINALE MINIFIT FEMMINA</td> <td>2</td> <td>PZ</td> </tr> <tr> <td>CE1740A0</td> <td>TERMINALE MINIFIT MASCIO</td> <td>4</td> <td>PZ</td> </tr> <tr> <td>CE1745A0</td> <td>CONNETTORE MINIFIT FEMMINA 2 VI</td> <td>2</td> <td>PZ</td> </tr> <tr> <td>CE1750A0</td> <td>CONNETTORE MINIFIT MASCIO 3 VI</td> <td>1</td> <td>PZ</td> </tr> <tr> <td>LP1001B0</td> <td>BARRA ILLUMINAZION E LED L300</td> <td>1</td> <td>PZ</td> </tr> </tbody> </table>	Codice	Descrizione	Qtà	UM	CE1455A0	TERMINALE A PUNTALE	2	PZ	CE1730A0	CAVO PVC NP 2 X AWG22 STYLE 2095	4.500	M	CE1735A0	TERMINALE MINIFIT FEMMINA	2	PZ	CE1740A0	TERMINALE MINIFIT MASCIO	4	PZ	CE1745A0	CONNETTORE MINIFIT FEMMINA 2 VI	2	PZ	CE1750A0	CONNETTORE MINIFIT MASCIO 3 VI	1	PZ	LP1001B0	BARRA ILLUMINAZION E LED L300	1	PZ								
Codice	Descrizione	Qtà	UM																																							
CE1455A0	TERMINALE A PUNTALE	2	PZ																																							
CE1730A0	CAVO PVC NP 2 X AWG22 STYLE 2095	4.500	M																																							
CE1735A0	TERMINALE MINIFIT FEMMINA	2	PZ																																							
CE1740A0	TERMINALE MINIFIT MASCIO	4	PZ																																							
CE1745A0	CONNETTORE MINIFIT FEMMINA 2 VI	2	PZ																																							
CE1750A0	CONNETTORE MINIFIT MASCIO 3 VI	1	PZ																																							
LP1001B0	BARRA ILLUMINAZION E LED L300	1	PZ																																							



COMPONENTE			RICAMBIO																																										
Codice	Descrizione	Immagine	Codice	Descrizione	Lista componenti																																								
VM1620A	SUPPORTO INF BARRA LED		KLP1001B	KIT RICAMBIO BARRA LED L300	<table border="1"> <thead> <tr> <th>Codice</th> <th>Descrizione</th> <th>Qtà</th> <th>UM</th> </tr> </thead> <tbody> <tr> <td>VM1620A0</td> <td>SUPPORTO INF BARRA LE</td> <td>1</td> <td>PZ</td> </tr> <tr> <td>VM1621A0</td> <td>SUPPORTO SUP BARRA LED</td> <td>1</td> <td>PZ</td> </tr> </tbody> </table>	Codice	Descrizione	Qtà	UM	VM1620A0	SUPPORTO INF BARRA LE	1	PZ	VM1621A0	SUPPORTO SUP BARRA LED	1	PZ																												
			Codice	Descrizione	Qtà	UM																																							
VM1620A0	SUPPORTO INF BARRA LE	1	PZ																																										
VM1621A0	SUPPORTO SUP BARRA LED	1	PZ																																										
KLP1000A	KIT RICAMBIO BARRA LED L100	<table border="1"> <thead> <tr> <th>Codice</th> <th>Descrizione</th> <th>Qtà</th> <th>UM</th> </tr> </thead> <tbody> <tr> <td>LP1000A0</td> <td>BARRA ILLUMINAZION E LED L100</td> <td>1</td> <td>PZ</td> </tr> <tr> <td>VM1620A0</td> <td>SUPPORTO INF BARRA LE</td> <td>1</td> <td>PZ</td> </tr> <tr> <td>VM1621A0</td> <td>SUPPORTO SUP BARRA LED</td> <td>1</td> <td>PZ</td> </tr> </tbody> </table>	Codice	Descrizione	Qtà	UM	LP1000A0	BARRA ILLUMINAZION E LED L100	1	PZ	VM1620A0	SUPPORTO INF BARRA LE	1	PZ	VM1621A0	SUPPORTO SUP BARRA LED	1	PZ																											
Codice	Descrizione	Qtà	UM																																										
LP1000A0	BARRA ILLUMINAZION E LED L100	1	PZ																																										
VM1620A0	SUPPORTO INF BARRA LE	1	PZ																																										
VM1621A0	SUPPORTO SUP BARRA LED	1	PZ																																										
VM1621A	SUPPORTO SUP BARRA LED		KLP1044A	KIT BARRA ILLUMINAZIONE LED LUX	<table border="1"> <thead> <tr> <th>Codice</th> <th>Descrizione</th> <th>Qtà</th> <th>UM</th> </tr> </thead> <tbody> <tr> <td>CE1455A0</td> <td>TERMINALE A PUNTALE</td> <td>2</td> <td>PZ</td> </tr> <tr> <td>CE1730A0</td> <td>CAVO PVC NP 2 X AWG22 STYLE 2095</td> <td>4.500</td> <td>M</td> </tr> <tr> <td>CE1735A0</td> <td>TERMINALE MINIFIT FEMMINA</td> <td>2</td> <td>PZ</td> </tr> <tr> <td>CE1740A0</td> <td>TERMINALE MINIFIT MASCHIO</td> <td>4</td> <td>PZ</td> </tr> <tr> <td>CE1745A0</td> <td>CONNETTORE MINIFIT FEMMINA 2 VI</td> <td>2</td> <td>PZ</td> </tr> <tr> <td>CE1750A0</td> <td>CONNETTORE MINIFIT MASCHIO 3 VI</td> <td>1</td> <td>PZ</td> </tr> <tr> <td>LP1044A0</td> <td>BARRA ILLUMINAZION E LED LUX</td> <td>1</td> <td>PZ</td> </tr> <tr> <td>VM1620A0</td> <td>SUPPORTO INF BARRA LE</td> <td>1</td> <td>PZ</td> </tr> <tr> <td>VM1621A0</td> <td>SUPPORTO SUP BARRA LED</td> <td>1</td> <td>PZ</td> </tr> </tbody> </table>	Codice	Descrizione	Qtà	UM	CE1455A0	TERMINALE A PUNTALE	2	PZ	CE1730A0	CAVO PVC NP 2 X AWG22 STYLE 2095	4.500	M	CE1735A0	TERMINALE MINIFIT FEMMINA	2	PZ	CE1740A0	TERMINALE MINIFIT MASCHIO	4	PZ	CE1745A0	CONNETTORE MINIFIT FEMMINA 2 VI	2	PZ	CE1750A0	CONNETTORE MINIFIT MASCHIO 3 VI	1	PZ	LP1044A0	BARRA ILLUMINAZION E LED LUX	1	PZ	VM1620A0	SUPPORTO INF BARRA LE	1	PZ	VM1621A0	SUPPORTO SUP BARRA LED	1	PZ
					Codice	Descrizione	Qtà	UM																																					
					CE1455A0	TERMINALE A PUNTALE	2	PZ																																					
					CE1730A0	CAVO PVC NP 2 X AWG22 STYLE 2095	4.500	M																																					
					CE1735A0	TERMINALE MINIFIT FEMMINA	2	PZ																																					
					CE1740A0	TERMINALE MINIFIT MASCHIO	4	PZ																																					
					CE1745A0	CONNETTORE MINIFIT FEMMINA 2 VI	2	PZ																																					
					CE1750A0	CONNETTORE MINIFIT MASCHIO 3 VI	1	PZ																																					
					LP1044A0	BARRA ILLUMINAZION E LED LUX	1	PZ																																					
					VM1620A0	SUPPORTO INF BARRA LE	1	PZ																																					
VM1621A0	SUPPORTO SUP BARRA LED	1	PZ																																										
KLP1007A	KIT BARRA LED L200	<table border="1"> <thead> <tr> <th>Codice</th> <th>Descrizione</th> <th>Qtà</th> <th>UM</th> </tr> </thead> <tbody> <tr> <td>CE1455A0</td> <td>TERMINALE A PUNTALE</td> <td>2</td> <td>PZ</td> </tr> <tr> <td>CE1730A0</td> <td>CAVO PVC NP 2 X AWG22 STYLE 2095</td> <td>4.500</td> <td>M</td> </tr> <tr> <td>CE1735A0</td> <td>TERMINALE MINIFIT FEMMINA</td> <td>2</td> <td>PZ</td> </tr> <tr> <td>CE1740A0</td> <td>TERMINALE MINIFIT MASCHIO</td> <td>4</td> <td>PZ</td> </tr> </tbody> </table>	Codice	Descrizione	Qtà	UM	CE1455A0	TERMINALE A PUNTALE	2	PZ	CE1730A0	CAVO PVC NP 2 X AWG22 STYLE 2095	4.500	M	CE1735A0	TERMINALE MINIFIT FEMMINA	2	PZ	CE1740A0	TERMINALE MINIFIT MASCHIO	4	PZ																							
		Codice	Descrizione	Qtà	UM																																								
		CE1455A0	TERMINALE A PUNTALE	2	PZ																																								
		CE1730A0	CAVO PVC NP 2 X AWG22 STYLE 2095	4.500	M																																								
		CE1735A0	TERMINALE MINIFIT FEMMINA	2	PZ																																								
		CE1740A0	TERMINALE MINIFIT MASCHIO	4	PZ																																								

COMPONENTE			RICAMBIO																																											
Codice	Descrizione	Immagine	Codice	Descrizione	Lista componenti																																									
VM1621A	SUPPORTO SUP BARRA LED		KLP1007A	KIT BARRA LED L200	<table border="1"> <thead> <tr> <th>Codice</th> <th>Descrizione</th> <th>Qtà</th> <th>UM</th> </tr> </thead> <tbody> <tr> <td>CE1745A0</td> <td>CONNETTORE MINIFIT FEMMINA 2 VI</td> <td>2</td> <td>PZ</td> </tr> <tr> <td>CE1750A0</td> <td>CONNETTORE MINIFIT MASCHIO 3 VI</td> <td>1</td> <td>PZ</td> </tr> <tr> <td>LP1007A0</td> <td>BARRA ILLUMINAZION E LED L200</td> <td>1</td> <td>PZ</td> </tr> <tr> <td>VM1620A0</td> <td>SUPPORTO INF BARRA LE</td> <td>1</td> <td>PZ</td> </tr> <tr> <td>VM1621A0</td> <td>SUPPORTO SUP BARRA LED</td> <td>1</td> <td>PZ</td> </tr> </tbody> </table>	Codice	Descrizione	Qtà	UM	CE1745A0	CONNETTORE MINIFIT FEMMINA 2 VI	2	PZ	CE1750A0	CONNETTORE MINIFIT MASCHIO 3 VI	1	PZ	LP1007A0	BARRA ILLUMINAZION E LED L200	1	PZ	VM1620A0	SUPPORTO INF BARRA LE	1	PZ	VM1621A0	SUPPORTO SUP BARRA LED	1	PZ																	
			Codice	Descrizione	Qtà	UM																																								
			CE1745A0	CONNETTORE MINIFIT FEMMINA 2 VI	2	PZ																																								
CE1750A0	CONNETTORE MINIFIT MASCHIO 3 VI	1	PZ																																											
LP1007A0	BARRA ILLUMINAZION E LED L200	1	PZ																																											
VM1620A0	SUPPORTO INF BARRA LE	1	PZ																																											
VM1621A0	SUPPORTO SUP BARRA LED	1	PZ																																											
KLP1004B	KIT RICAMBIO BARRA LED L1000	<table border="1"> <thead> <tr> <th>Codice</th> <th>Descrizione</th> <th>Qtà</th> <th>UM</th> </tr> </thead> <tbody> <tr> <td>CE1730A0</td> <td>CAVO PVC NP 2 X AWG22 STYLE 2095</td> <td>1</td> <td>M</td> </tr> <tr> <td>CE1735A0</td> <td>TERMINALE MINIFIT FEMMINA</td> <td>2</td> <td>PZ</td> </tr> <tr> <td>CE1740A0</td> <td>TERMINALE MINIFIT MASCHIO</td> <td>2</td> <td>PZ</td> </tr> <tr> <td>CE1745A0</td> <td>CONNETTORE MINIFIT FEMMINA 2 VI</td> <td>1</td> <td>PZ</td> </tr> <tr> <td>CE1750A0</td> <td>CONNETTORE MINIFIT MASCHIO 3 VI</td> <td>1</td> <td>PZ</td> </tr> <tr> <td>IP1385A1</td> <td>IMB POL ANGOLARE 110X80X2000 D30</td> <td>2.200</td> <td>M</td> </tr> <tr> <td>LP1004B0</td> <td>BARRA ILLUMINAZION E LED L1000</td> <td>1</td> <td>PZ</td> </tr> <tr> <td>VM1059A1</td> <td>FILM TERMORETRA IBILE H800</td> <td>1.300</td> <td>M</td> </tr> <tr> <td>VM1620A0</td> <td>SUPPORTO INF BARRA LE</td> <td>1</td> <td>PZ</td> </tr> <tr> <td>VM1621A0</td> <td>SUPPORTO SUP BARRA LED</td> <td>1</td> <td>PZ</td> </tr> </tbody> </table>	Codice	Descrizione	Qtà	UM	CE1730A0	CAVO PVC NP 2 X AWG22 STYLE 2095	1	M	CE1735A0	TERMINALE MINIFIT FEMMINA	2	PZ	CE1740A0	TERMINALE MINIFIT MASCHIO	2	PZ	CE1745A0	CONNETTORE MINIFIT FEMMINA 2 VI	1	PZ	CE1750A0	CONNETTORE MINIFIT MASCHIO 3 VI	1	PZ	IP1385A1	IMB POL ANGOLARE 110X80X2000 D30	2.200	M	LP1004B0	BARRA ILLUMINAZION E LED L1000	1	PZ	VM1059A1	FILM TERMORETRA IBILE H800	1.300	M	VM1620A0	SUPPORTO INF BARRA LE	1	PZ	VM1621A0	SUPPORTO SUP BARRA LED	1	PZ
Codice	Descrizione	Qtà	UM																																											
CE1730A0	CAVO PVC NP 2 X AWG22 STYLE 2095	1	M																																											
CE1735A0	TERMINALE MINIFIT FEMMINA	2	PZ																																											
CE1740A0	TERMINALE MINIFIT MASCHIO	2	PZ																																											
CE1745A0	CONNETTORE MINIFIT FEMMINA 2 VI	1	PZ																																											
CE1750A0	CONNETTORE MINIFIT MASCHIO 3 VI	1	PZ																																											
IP1385A1	IMB POL ANGOLARE 110X80X2000 D30	2.200	M																																											
LP1004B0	BARRA ILLUMINAZION E LED L1000	1	PZ																																											
VM1059A1	FILM TERMORETRA IBILE H800	1.300	M																																											
VM1620A0	SUPPORTO INF BARRA LE	1	PZ																																											
VM1621A0	SUPPORTO SUP BARRA LED	1	PZ																																											
KLP1003B	KIT RICAMBIO BARRA LED L600	<table border="1"> <thead> <tr> <th>Codice</th> <th>Descrizione</th> <th>Qtà</th> <th>UM</th> </tr> </thead> <tbody> <tr> <td>CE1730A0</td> <td>CAVO PVC NP 2 X AWG22 STYLE 2095</td> <td>1</td> <td>M</td> </tr> <tr> <td>CE1735A0</td> <td>TERMINALE MINIFIT FEMMINA</td> <td>2</td> <td>PZ</td> </tr> </tbody> </table>	Codice	Descrizione	Qtà	UM	CE1730A0	CAVO PVC NP 2 X AWG22 STYLE 2095	1	M	CE1735A0	TERMINALE MINIFIT FEMMINA	2	PZ																																
Codice	Descrizione	Qtà	UM																																											
CE1730A0	CAVO PVC NP 2 X AWG22 STYLE 2095	1	M																																											
CE1735A0	TERMINALE MINIFIT FEMMINA	2	PZ																																											

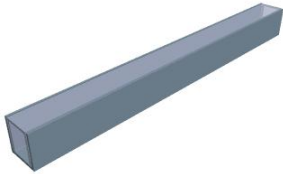
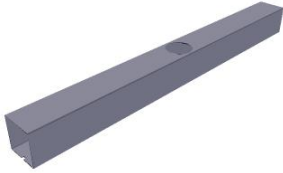
COMPONENTE			RICAMBIO																																							
Codice	Descrizione	Immagine	Codice	Descrizione	Lista componenti																																					
VM1621A	SUPPORTO SUP BARRA LED		KLP1003B	KIT RICAMBIO BARRA LED L600	<table border="1"> <thead> <tr> <th>Codice</th> <th>Descrizione</th> <th>Qtà</th> <th>UM</th> </tr> </thead> <tbody> <tr> <td>CE1740A0</td> <td>TERMINALE MINIFIT MASCHIO</td> <td>2</td> <td>PZ</td> </tr> <tr> <td>CE1745A0</td> <td>CONNETTORE MINIFIT FEMMINA 2 VI</td> <td>1</td> <td>PZ</td> </tr> <tr> <td>CE1750A0</td> <td>CONNETTORE MINIFIT MASCHIO 3 VI</td> <td>1</td> <td>PZ</td> </tr> <tr> <td>LP1003B0</td> <td>BARRA ILLUMINAZION E LED L600</td> <td>1</td> <td>PZ</td> </tr> <tr> <td>VM1620A0</td> <td>SUPPORTO INF BARRA LE</td> <td>1</td> <td>PZ</td> </tr> <tr> <td>VM1621A0</td> <td>SUPPORTO SUP BARRA LED</td> <td>1</td> <td>PZ</td> </tr> <tr> <td>VM1794A0</td> <td>FASCETTA 430X4.8 PA66 NERA</td> <td>2</td> <td>PZ</td> </tr> <tr> <td>VM2103A0</td> <td>PIASTRINA FERMAFASCE TTA</td> <td>2</td> <td>PZ</td> </tr> </tbody> </table>	Codice	Descrizione	Qtà	UM	CE1740A0	TERMINALE MINIFIT MASCHIO	2	PZ	CE1745A0	CONNETTORE MINIFIT FEMMINA 2 VI	1	PZ	CE1750A0	CONNETTORE MINIFIT MASCHIO 3 VI	1	PZ	LP1003B0	BARRA ILLUMINAZION E LED L600	1	PZ	VM1620A0	SUPPORTO INF BARRA LE	1	PZ	VM1621A0	SUPPORTO SUP BARRA LED	1	PZ	VM1794A0	FASCETTA 430X4.8 PA66 NERA	2	PZ	VM2103A0	PIASTRINA FERMAFASCE TTA	2	PZ	
			Codice	Descrizione	Qtà	UM																																				
			CE1740A0	TERMINALE MINIFIT MASCHIO	2	PZ																																				
CE1745A0	CONNETTORE MINIFIT FEMMINA 2 VI	1	PZ																																							
CE1750A0	CONNETTORE MINIFIT MASCHIO 3 VI	1	PZ																																							
LP1003B0	BARRA ILLUMINAZION E LED L600	1	PZ																																							
VM1620A0	SUPPORTO INF BARRA LE	1	PZ																																							
VM1621A0	SUPPORTO SUP BARRA LED	1	PZ																																							
VM1794A0	FASCETTA 430X4.8 PA66 NERA	2	PZ																																							
VM2103A0	PIASTRINA FERMAFASCE TTA	2	PZ																																							
KLP1002B	KIT RICAMBIO BARRA LED L400	<table border="1"> <thead> <tr> <th>Codice</th> <th>Descrizione</th> <th>Qtà</th> <th>UM</th> </tr> </thead> <tbody> <tr> <td>CE1455A0</td> <td>TERMINALE A PUNTALE</td> <td>2</td> <td>PZ</td> </tr> <tr> <td>CE1730A0</td> <td>CAVO PVC NP 2 X AWG22 STYLE 2095</td> <td>4.500</td> <td>M</td> </tr> <tr> <td>CE1735A0</td> <td>TERMINALE MINIFIT FEMMINA</td> <td>2</td> <td>PZ</td> </tr> <tr> <td>CE1740A0</td> <td>TERMINALE MINIFIT MASCHIO</td> <td>4</td> <td>PZ</td> </tr> <tr> <td>CE1745A0</td> <td>CONNETTORE MINIFIT FEMMINA 2 VI</td> <td>2</td> <td>PZ</td> </tr> <tr> <td>CE1750A0</td> <td>CONNETTORE MINIFIT MASCHIO 3 VI</td> <td>1</td> <td>PZ</td> </tr> <tr> <td>LP1002B0</td> <td>BARRA ILLUMINAZION E LED L400</td> <td>1</td> <td>PZ</td> </tr> <tr> <td>VM1620A0</td> <td>SUPPORTO INF BARRA LE</td> <td>1</td> <td>PZ</td> </tr> <tr> <td>VM1621A0</td> <td>SUPPORTO SUP BARRA LED</td> <td>1</td> <td>PZ</td> </tr> </tbody> </table>	Codice	Descrizione	Qtà	UM	CE1455A0	TERMINALE A PUNTALE	2	PZ	CE1730A0	CAVO PVC NP 2 X AWG22 STYLE 2095	4.500	M	CE1735A0	TERMINALE MINIFIT FEMMINA	2	PZ	CE1740A0	TERMINALE MINIFIT MASCHIO	4	PZ	CE1745A0	CONNETTORE MINIFIT FEMMINA 2 VI	2	PZ	CE1750A0	CONNETTORE MINIFIT MASCHIO 3 VI	1	PZ	LP1002B0	BARRA ILLUMINAZION E LED L400	1	PZ	VM1620A0	SUPPORTO INF BARRA LE	1	PZ	VM1621A0	SUPPORTO SUP BARRA LED	1	PZ
Codice	Descrizione	Qtà	UM																																							
CE1455A0	TERMINALE A PUNTALE	2	PZ																																							
CE1730A0	CAVO PVC NP 2 X AWG22 STYLE 2095	4.500	M																																							
CE1735A0	TERMINALE MINIFIT FEMMINA	2	PZ																																							
CE1740A0	TERMINALE MINIFIT MASCHIO	4	PZ																																							
CE1745A0	CONNETTORE MINIFIT FEMMINA 2 VI	2	PZ																																							
CE1750A0	CONNETTORE MINIFIT MASCHIO 3 VI	1	PZ																																							
LP1002B0	BARRA ILLUMINAZION E LED L400	1	PZ																																							
VM1620A0	SUPPORTO INF BARRA LE	1	PZ																																							
VM1621A0	SUPPORTO SUP BARRA LED	1	PZ																																							
KLP1001B	KIT RICAMBIO BARRA LED L300	<table border="1"> <thead> <tr> <th>Codice</th> <th>Descrizione</th> <th>Qtà</th> <th>UM</th> </tr> </thead> <tbody> <tr> <td>CE1455A0</td> <td>TERMINALE A PUNTALE</td> <td>2</td> <td>PZ</td> </tr> </tbody> </table>	Codice	Descrizione	Qtà	UM	CE1455A0	TERMINALE A PUNTALE	2	PZ																																
Codice	Descrizione	Qtà	UM																																							
CE1455A0	TERMINALE A PUNTALE	2	PZ																																							

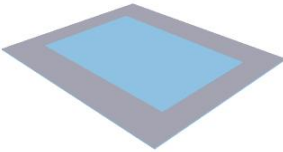
COMPONENTE			RICAMBIO																																						
Codice	Descrizione	Immagine	Codice	Descrizione	Lista componenti																																				
VM1621A	SUPPORTO SUP BARRA LED		KLP1001B	KIT RICAMBIO BARRA LED L300	<table border="1"> <thead> <tr> <th>Codice</th> <th>Descrizione</th> <th>Qtà</th> <th>UM</th> </tr> </thead> <tbody> <tr> <td>CE1730A0</td> <td>CAVO PVC NP 2 X AWG22 STYLE 2095</td> <td>4.500</td> <td>M</td> </tr> <tr> <td>CE1735A0</td> <td>TERMINALE MINIFIT FEMMINA</td> <td>2</td> <td>PZ</td> </tr> <tr> <td>CE1740A0</td> <td>TERMINALE MINIFIT MASCHIO</td> <td>4</td> <td>PZ</td> </tr> <tr> <td>CE1745A0</td> <td>CONNETTORE MINIFIT FEMMINA 2 VI</td> <td>2</td> <td>PZ</td> </tr> <tr> <td>CE1750A0</td> <td>CONNETTORE MINIFIT MASCHIO 3 VI</td> <td>1</td> <td>PZ</td> </tr> <tr> <td>LP1001B0</td> <td>BARRA ILLUMINAZION E LED L300</td> <td>1</td> <td>PZ</td> </tr> <tr> <td>VM1620A0</td> <td>SUPPORTO INF BARRA LE</td> <td>1</td> <td>PZ</td> </tr> <tr> <td>VM1621A0</td> <td>SUPPORTO SUP BARRA LED</td> <td>1</td> <td>PZ</td> </tr> </tbody> </table>	Codice	Descrizione	Qtà	UM	CE1730A0	CAVO PVC NP 2 X AWG22 STYLE 2095	4.500	M	CE1735A0	TERMINALE MINIFIT FEMMINA	2	PZ	CE1740A0	TERMINALE MINIFIT MASCHIO	4	PZ	CE1745A0	CONNETTORE MINIFIT FEMMINA 2 VI	2	PZ	CE1750A0	CONNETTORE MINIFIT MASCHIO 3 VI	1	PZ	LP1001B0	BARRA ILLUMINAZION E LED L300	1	PZ	VM1620A0	SUPPORTO INF BARRA LE	1	PZ	VM1621A0	SUPPORTO SUP BARRA LED	1	PZ
			Codice	Descrizione	Qtà	UM																																			
CE1730A0	CAVO PVC NP 2 X AWG22 STYLE 2095	4.500	M																																						
CE1735A0	TERMINALE MINIFIT FEMMINA	2	PZ																																						
CE1740A0	TERMINALE MINIFIT MASCHIO	4	PZ																																						
CE1745A0	CONNETTORE MINIFIT FEMMINA 2 VI	2	PZ																																						
CE1750A0	CONNETTORE MINIFIT MASCHIO 3 VI	1	PZ																																						
LP1001B0	BARRA ILLUMINAZION E LED L300	1	PZ																																						
VM1620A0	SUPPORTO INF BARRA LE	1	PZ																																						
VM1621A0	SUPPORTO SUP BARRA LED	1	PZ																																						
KLP1000A	KIT RICAMBIO BARRA LED L100	<table border="1"> <thead> <tr> <th>Codice</th> <th>Descrizione</th> <th>Qtà</th> <th>UM</th> </tr> </thead> <tbody> <tr> <td>LP1000A0</td> <td>BARRA ILLUMINAZION E LED L100</td> <td>1</td> <td>PZ</td> </tr> <tr> <td>VM1620A0</td> <td>SUPPORTO INF BARRA LE</td> <td>1</td> <td>PZ</td> </tr> <tr> <td>VM1621A0</td> <td>SUPPORTO SUP BARRA LED</td> <td>1</td> <td>PZ</td> </tr> </tbody> </table>	Codice	Descrizione	Qtà	UM	LP1000A0	BARRA ILLUMINAZION E LED L100	1	PZ	VM1620A0	SUPPORTO INF BARRA LE	1	PZ	VM1621A0	SUPPORTO SUP BARRA LED	1	PZ																							
Codice	Descrizione	Qtà	UM																																						
LP1000A0	BARRA ILLUMINAZION E LED L100	1	PZ																																						
VM1620A0	SUPPORTO INF BARRA LE	1	PZ																																						
VM1621A0	SUPPORTO SUP BARRA LED	1	PZ																																						
LP1044A	BARRA ILLUMINAZIONE LED LUX		KLP1044A	KIT BARRA ILLUMINAZIONE LED LUX	<table border="1"> <thead> <tr> <th>Codice</th> <th>Descrizione</th> <th>Qtà</th> <th>UM</th> </tr> </thead> <tbody> <tr> <td>CE1455A0</td> <td>TERMINALE A PUNTALE</td> <td>2</td> <td>PZ</td> </tr> <tr> <td>CE1730A0</td> <td>CAVO PVC NP 2 X AWG22 STYLE 2095</td> <td>4.500</td> <td>M</td> </tr> <tr> <td>CE1735A0</td> <td>TERMINALE MINIFIT FEMMINA</td> <td>2</td> <td>PZ</td> </tr> <tr> <td>CE1740A0</td> <td>TERMINALE MINIFIT MASCHIO</td> <td>4</td> <td>PZ</td> </tr> <tr> <td>CE1745A0</td> <td>CONNETTORE MINIFIT FEMMINA 2 VI</td> <td>2</td> <td>PZ</td> </tr> <tr> <td>CE1750A0</td> <td>CONNETTORE MINIFIT MASCHIO 3 VI</td> <td>1</td> <td>PZ</td> </tr> <tr> <td>LP1044A0</td> <td>BARRA ILLUMINAZION E LED LUX</td> <td>1</td> <td>PZ</td> </tr> </tbody> </table>	Codice	Descrizione	Qtà	UM	CE1455A0	TERMINALE A PUNTALE	2	PZ	CE1730A0	CAVO PVC NP 2 X AWG22 STYLE 2095	4.500	M	CE1735A0	TERMINALE MINIFIT FEMMINA	2	PZ	CE1740A0	TERMINALE MINIFIT MASCHIO	4	PZ	CE1745A0	CONNETTORE MINIFIT FEMMINA 2 VI	2	PZ	CE1750A0	CONNETTORE MINIFIT MASCHIO 3 VI	1	PZ	LP1044A0	BARRA ILLUMINAZION E LED LUX	1	PZ				
Codice	Descrizione	Qtà	UM																																						
CE1455A0	TERMINALE A PUNTALE	2	PZ																																						
CE1730A0	CAVO PVC NP 2 X AWG22 STYLE 2095	4.500	M																																						
CE1735A0	TERMINALE MINIFIT FEMMINA	2	PZ																																						
CE1740A0	TERMINALE MINIFIT MASCHIO	4	PZ																																						
CE1745A0	CONNETTORE MINIFIT FEMMINA 2 VI	2	PZ																																						
CE1750A0	CONNETTORE MINIFIT MASCHIO 3 VI	1	PZ																																						
LP1044A0	BARRA ILLUMINAZION E LED LUX	1	PZ																																						

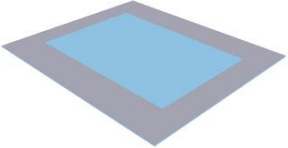
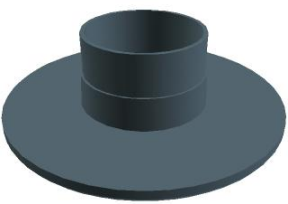
COMPONENTE			RICAMBIO																						
Codice	Descrizione	Immagine	Codice	Descrizione	Lista componenti																				
LP1044A	BARRA ILLUMINAZIONE LED LUX		KLP1044A	KIT BARRA ILLUMINAZIONE LED LUX	<table border="1"> <thead> <tr> <th>Codice</th> <th>Descrizione</th> <th>Qtà</th> <th>UM</th> </tr> </thead> <tbody> <tr> <td>VM1620A0</td> <td>SUPPORTO INF BARRA LE</td> <td>1</td> <td>PZ</td> </tr> <tr> <td>VM1621A0</td> <td>SUPPORTO SUP BARRA LED</td> <td>1</td> <td>PZ</td> </tr> </tbody> </table>	Codice	Descrizione	Qtà	UM	VM1620A0	SUPPORTO INF BARRA LE	1	PZ	VM1621A0	SUPPORTO SUP BARRA LED	1	PZ								
Codice	Descrizione	Qtà	UM																						
VM1620A0	SUPPORTO INF BARRA LE	1	PZ																						
VM1621A0	SUPPORTO SUP BARRA LED	1	PZ																						
TB3097A	COLONNINA DX CHEFLUX XV393		TB3097A0	COLONNINA DX CHEFLUX XV393																					
TB2778A	LISTELLO SUP CHEFLUX		TB2778A0	LISTELLO SUP CHEFLUX																					
TB2779A	LISTELLO INF CHEFLUX		TB2779A0	LISTELLO INF CHEFLUX																					
VT1272A	VETRO EST. 647X555 NERO CHEFLUX		KVT1272A	KIT VETRO ESTERNO XV393	<table border="1"> <thead> <tr> <th>Codice</th> <th>Descrizione</th> <th>Qtà</th> <th>UM</th> </tr> </thead> <tbody> <tr> <td>0H7105A0</td> <td>PROFILO SUPPORTO VETRO EST CHEFLUX XV393</td> <td>2</td> <td>PZ</td> </tr> <tr> <td>IP1385A1</td> <td>IMB POL ANGOLARE 110X80X2000 D30</td> <td>1.230</td> <td>M</td> </tr> <tr> <td>IP1508A1</td> <td>POLISTIROLO PROFILO AD U 2000X60X60</td> <td>1.050</td> <td>M</td> </tr> <tr> <td>SL1155A1</td> <td>SILICONE BICOMPONEN TE LOCTITE</td> <td>0.160</td> <td>ML</td> </tr> </tbody> </table>	Codice	Descrizione	Qtà	UM	0H7105A0	PROFILO SUPPORTO VETRO EST CHEFLUX XV393	2	PZ	IP1385A1	IMB POL ANGOLARE 110X80X2000 D30	1.230	M	IP1508A1	POLISTIROLO PROFILO AD U 2000X60X60	1.050	M	SL1155A1	SILICONE BICOMPONEN TE LOCTITE	0.160	ML
Codice	Descrizione	Qtà	UM																						
0H7105A0	PROFILO SUPPORTO VETRO EST CHEFLUX XV393	2	PZ																						
IP1385A1	IMB POL ANGOLARE 110X80X2000 D30	1.230	M																						
IP1508A1	POLISTIROLO PROFILO AD U 2000X60X60	1.050	M																						
SL1155A1	SILICONE BICOMPONEN TE LOCTITE	0.160	ML																						

COMPONENTE			RICAMBIO																																						
Codice	Descrizione	Immagine	Codice	Descrizione	Lista componenti																																				
VT1272A	VETRO EST. 647X555 NERO CHEFLUX		KVT1272A	KIT VETRO ESTERNO XV393	<table border="1"> <thead> <tr> <th>Codice</th> <th>Descrizione</th> <th>Qtà</th> <th>UM</th> </tr> </thead> <tbody> <tr> <td>SL1156A0</td> <td>PUNTALE PER PISTOLA SILICONE BICOMPONEN</td> <td>1</td> <td>PZ</td> </tr> <tr> <td>VM1059A1</td> <td>FILM TERMORETRA IBILE H800</td> <td>1.300</td> <td>M</td> </tr> <tr> <td>VT1272A0</td> <td>VETRO EST. 647X555 NERO CHEFLUX</td> <td>1</td> <td>PZ</td> </tr> <tr> <td>VT1272A0</td> <td>VETRO EST. 647X555 NERO CHEFLUX</td> <td>1</td> <td>PZ</td> </tr> </tbody> </table>	Codice	Descrizione	Qtà	UM	SL1156A0	PUNTALE PER PISTOLA SILICONE BICOMPONEN	1	PZ	VM1059A1	FILM TERMORETRA IBILE H800	1.300	M	VT1272A0	VETRO EST. 647X555 NERO CHEFLUX	1	PZ	VT1272A0	VETRO EST. 647X555 NERO CHEFLUX	1	PZ																
Codice	Descrizione	Qtà	UM																																						
SL1156A0	PUNTALE PER PISTOLA SILICONE BICOMPONEN	1	PZ																																						
VM1059A1	FILM TERMORETRA IBILE H800	1.300	M																																						
VT1272A0	VETRO EST. 647X555 NERO CHEFLUX	1	PZ																																						
VT1272A0	VETRO EST. 647X555 NERO CHEFLUX	1	PZ																																						
VM2000A	TAPPO COPRIVITE A BRUGOLA M4		VM2000A0	TAPPO COPRIVITE A BRUGOLA M4																																					
CR1085A	CERNIERA VETRO INT INOX SUP		KVM0012A	KIT CONV. APERTURA VETRO INT. S. 4-5-5E	<table border="1"> <thead> <tr> <th>Codice</th> <th>Descrizione</th> <th>Qtà</th> <th>UM</th> </tr> </thead> <tbody> <tr> <td>CR1085A0</td> <td>CERNIERA VETRO INT INOX SUP</td> <td>1</td> <td>PZ</td> </tr> <tr> <td>CR1086A0</td> <td>CERNIERA VETRO INT INOX INF</td> <td>1</td> <td>PZ</td> </tr> <tr> <td>GN1181A0</td> <td>GUARNIZIONE CERN VETRO INT CR1085-1086</td> <td>2</td> <td>PZ</td> </tr> <tr> <td>VI1220A1</td> <td>VITE AUTOFILETTA NTE 4.2X11 TCS+ MARUTE</td> <td>5</td> <td>PZ</td> </tr> <tr> <td>VI1300A0</td> <td>VITE M6X12 T1/2T+ INOX</td> <td>4</td> <td>PZ</td> </tr> <tr> <td>VI1810A0</td> <td>VITE NO TESTA EI M6X6 TESTA PIANA INOX</td> <td>6</td> <td>PZ</td> </tr> <tr> <td>VI1950A0</td> <td>VITE AUTOFORANT E 4,2X13 TCB INOX</td> <td>6</td> <td>PZ</td> </tr> <tr> <td>VM1224A0</td> <td>TUBOLARE TERMORETR 65MY 220MM 2 COLORI</td> <td>0.300</td> <td>M</td> </tr> </tbody> </table>	Codice	Descrizione	Qtà	UM	CR1085A0	CERNIERA VETRO INT INOX SUP	1	PZ	CR1086A0	CERNIERA VETRO INT INOX INF	1	PZ	GN1181A0	GUARNIZIONE CERN VETRO INT CR1085-1086	2	PZ	VI1220A1	VITE AUTOFILETTA NTE 4.2X11 TCS+ MARUTE	5	PZ	VI1300A0	VITE M6X12 T1/2T+ INOX	4	PZ	VI1810A0	VITE NO TESTA EI M6X6 TESTA PIANA INOX	6	PZ	VI1950A0	VITE AUTOFORANT E 4,2X13 TCB INOX	6	PZ	VM1224A0	TUBOLARE TERMORETR 65MY 220MM 2 COLORI	0.300	M
Codice	Descrizione	Qtà	UM																																						
CR1085A0	CERNIERA VETRO INT INOX SUP	1	PZ																																						
CR1086A0	CERNIERA VETRO INT INOX INF	1	PZ																																						
GN1181A0	GUARNIZIONE CERN VETRO INT CR1085-1086	2	PZ																																						
VI1220A1	VITE AUTOFILETTA NTE 4.2X11 TCS+ MARUTE	5	PZ																																						
VI1300A0	VITE M6X12 T1/2T+ INOX	4	PZ																																						
VI1810A0	VITE NO TESTA EI M6X6 TESTA PIANA INOX	6	PZ																																						
VI1950A0	VITE AUTOFORANT E 4,2X13 TCB INOX	6	PZ																																						
VM1224A0	TUBOLARE TERMORETR 65MY 220MM 2 COLORI	0.300	M																																						

COMPONENTE			RICAMBIO																			
Codice	Descrizione	Immagine	Codice	Descrizione	Lista componenti																	
CR1085A	CERNIERA VETRO INT INOX SUP		KVM0012A	KIT CONV. APERTURA VETRO INT. S. 4-5-5E	<table border="1"> <thead> <tr> <th>Codice</th> <th>Descrizione</th> <th>Qtà</th> <th>UM</th> </tr> </thead> <tbody> <tr> <td>VM1680A0</td> <td>CERNIERA APERTURA VETRO INTERNO</td> <td>2</td> <td>PZ</td> </tr> <tr> <td>VM2042A0</td> <td>ASSIEME CHIUSURA VETRO INTERNO LAT</td> <td>2</td> <td>PZ</td> </tr> <tr> <td>VM2043A0</td> <td>SUPPORTO VETRO SUP - INF</td> <td>2</td> <td>PZ</td> </tr> </tbody> </table>	Codice	Descrizione	Qtà	UM	VM1680A0	CERNIERA APERTURA VETRO INTERNO	2	PZ	VM2042A0	ASSIEME CHIUSURA VETRO INTERNO LAT	2	PZ	VM2043A0	SUPPORTO VETRO SUP - INF	2	PZ	
			Codice	Descrizione	Qtà	UM																
VM1680A0	CERNIERA APERTURA VETRO INTERNO	2	PZ																			
VM2042A0	ASSIEME CHIUSURA VETRO INTERNO LAT	2	PZ																			
VM2043A0	SUPPORTO VETRO SUP - INF	2	PZ																			
KCR1085A	KIT CERNIERA VETRO INT INOX SU	<table border="1"> <thead> <tr> <th>Codice</th> <th>Descrizione</th> <th>Qtà</th> <th>UM</th> </tr> </thead> <tbody> <tr> <td>CR1085A0</td> <td>CERNIERA VETRO INT INOX SUP</td> <td>1</td> <td>PZ</td> </tr> <tr> <td>GN1181A0</td> <td>GUARNIZIONE CERN VETRO INT CR1085-1086</td> <td>1</td> <td>PZ</td> </tr> <tr> <td>VI1810A0</td> <td>VITE NO TESTA EI M6X6 TESTA PIANA INOX</td> <td>3</td> <td>PZ</td> </tr> <tr> <td>VM1224A0</td> <td>TUBOLARE TERMORETR 65MY 220MM 2 COLORI</td> <td>0.200</td> <td>M</td> </tr> </tbody> </table>	Codice	Descrizione	Qtà	UM	CR1085A0	CERNIERA VETRO INT INOX SUP	1	PZ	GN1181A0	GUARNIZIONE CERN VETRO INT CR1085-1086	1	PZ	VI1810A0	VITE NO TESTA EI M6X6 TESTA PIANA INOX	3	PZ	VM1224A0	TUBOLARE TERMORETR 65MY 220MM 2 COLORI	0.200	M
Codice	Descrizione	Qtà	UM																			
CR1085A0	CERNIERA VETRO INT INOX SUP	1	PZ																			
GN1181A0	GUARNIZIONE CERN VETRO INT CR1085-1086	1	PZ																			
VI1810A0	VITE NO TESTA EI M6X6 TESTA PIANA INOX	3	PZ																			
VM1224A0	TUBOLARE TERMORETR 65MY 220MM 2 COLORI	0.200	M																			
GN1181A	GUARNIZIONE CERN VETRO INT CR1085-1086		KGN1181A	KIT 2 GUARNIZIONI CERNIERE VETRO INT.	<table border="1"> <thead> <tr> <th>Codice</th> <th>Descrizione</th> <th>Qtà</th> <th>UM</th> </tr> </thead> <tbody> <tr> <td>GN1181A0</td> <td>GUARNIZIONE CERN VETRO INT CR1085-1086</td> <td>2</td> <td>PZ</td> </tr> <tr> <td>VM1224A0</td> <td>TUBOLARE TERMORETR 65MY 220MM 2 COLORI</td> <td>0.200</td> <td>M</td> </tr> </tbody> </table>	Codice	Descrizione	Qtà	UM	GN1181A0	GUARNIZIONE CERN VETRO INT CR1085-1086	2	PZ	VM1224A0	TUBOLARE TERMORETR 65MY 220MM 2 COLORI	0.200	M					
					Codice	Descrizione	Qtà	UM														
GN1181A0	GUARNIZIONE CERN VETRO INT CR1085-1086	2	PZ																			
VM1224A0	TUBOLARE TERMORETR 65MY 220MM 2 COLORI	0.200	M																			
VM2000A	TAPPO COPRIVITE A BRUGOLA M4		VM2000A0	TAPPO COPRIVITE A BRUGOLA M4																		

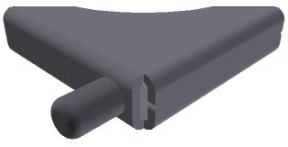
COMPONENTE			RICAMBIO																																																		
Codice	Descrizione	Immagine	Codice	Descrizione	Lista componenti																																																
GN1181A	GUARNIZIONE CERN VETRO INT CR1085-1086		KG1181A	KIT 2 GUARNIZIONI CERNIERE VETRO INT.	<table border="1"> <thead> <tr> <th>Codice</th> <th>Descrizione</th> <th>Qtà</th> <th>UM</th> </tr> </thead> <tbody> <tr> <td>GN1181A0</td> <td>GUARNIZIONE CERN VETRO INT CR1085-1086</td> <td>2</td> <td>PZ</td> </tr> <tr> <td>VM1224A0</td> <td>TUBOLARE TERMORETR 65MY 220MM 2 COLORI</td> <td>0.200</td> <td>M</td> </tr> </tbody> </table>	Codice	Descrizione	Qtà	UM	GN1181A0	GUARNIZIONE CERN VETRO INT CR1085-1086	2	PZ	VM1224A0	TUBOLARE TERMORETR 65MY 220MM 2 COLORI	0.200	M																																				
Codice	Descrizione	Qtà	UM																																																		
GN1181A0	GUARNIZIONE CERN VETRO INT CR1085-1086	2	PZ																																																		
VM1224A0	TUBOLARE TERMORETR 65MY 220MM 2 COLORI	0.200	M																																																		
CR1086A	CERNIERA VETRO INT INOX INF		KVM0012A	KIT CONV. APERTURA VETRO INT. S. 4-5-5E	<table border="1"> <thead> <tr> <th>Codice</th> <th>Descrizione</th> <th>Qtà</th> <th>UM</th> </tr> </thead> <tbody> <tr> <td>CR1085A0</td> <td>CERNIERA VETRO INT INOX SUP</td> <td>1</td> <td>PZ</td> </tr> <tr> <td>CR1086A0</td> <td>CERNIERA VETRO INT INOX INF</td> <td>1</td> <td>PZ</td> </tr> <tr> <td>GN1181A0</td> <td>GUARNIZIONE CERN VETRO INT CR1085-1086</td> <td>2</td> <td>PZ</td> </tr> <tr> <td>VI1220A1</td> <td>VITE AUTOFISETTA NTE 4.2X11 TCS+ MARUTE</td> <td>5</td> <td>PZ</td> </tr> <tr> <td>VI1300A0</td> <td>VITE M6X12 T1/2T+ INOX</td> <td>4</td> <td>PZ</td> </tr> <tr> <td>VI1810A0</td> <td>VITE NO TESTA EI M6X6 TESTA PIANA INOX</td> <td>6</td> <td>PZ</td> </tr> <tr> <td>VI1950A0</td> <td>VITE AUTOFORANT E 4,2X13 TCB INOX</td> <td>6</td> <td>PZ</td> </tr> <tr> <td>VM1224A0</td> <td>TUBOLARE TERMORETR 65MY 220MM 2 COLORI</td> <td>0.300</td> <td>M</td> </tr> <tr> <td>VM1680A0</td> <td>CERNIERA APERTURA VETRO INTERNO</td> <td>2</td> <td>PZ</td> </tr> <tr> <td>VM2042A0</td> <td>ASSIEME CHIUSURA VETRO INTERNO LAT</td> <td>2</td> <td>PZ</td> </tr> <tr> <td>VM2043A0</td> <td>SUPPORTO VETRO SUP - INF</td> <td>2</td> <td>PZ</td> </tr> </tbody> </table>	Codice	Descrizione	Qtà	UM	CR1085A0	CERNIERA VETRO INT INOX SUP	1	PZ	CR1086A0	CERNIERA VETRO INT INOX INF	1	PZ	GN1181A0	GUARNIZIONE CERN VETRO INT CR1085-1086	2	PZ	VI1220A1	VITE AUTOFISETTA NTE 4.2X11 TCS+ MARUTE	5	PZ	VI1300A0	VITE M6X12 T1/2T+ INOX	4	PZ	VI1810A0	VITE NO TESTA EI M6X6 TESTA PIANA INOX	6	PZ	VI1950A0	VITE AUTOFORANT E 4,2X13 TCB INOX	6	PZ	VM1224A0	TUBOLARE TERMORETR 65MY 220MM 2 COLORI	0.300	M	VM1680A0	CERNIERA APERTURA VETRO INTERNO	2	PZ	VM2042A0	ASSIEME CHIUSURA VETRO INTERNO LAT	2	PZ	VM2043A0	SUPPORTO VETRO SUP - INF	2	PZ
Codice	Descrizione	Qtà	UM																																																		
CR1085A0	CERNIERA VETRO INT INOX SUP	1	PZ																																																		
CR1086A0	CERNIERA VETRO INT INOX INF	1	PZ																																																		
GN1181A0	GUARNIZIONE CERN VETRO INT CR1085-1086	2	PZ																																																		
VI1220A1	VITE AUTOFISETTA NTE 4.2X11 TCS+ MARUTE	5	PZ																																																		
VI1300A0	VITE M6X12 T1/2T+ INOX	4	PZ																																																		
VI1810A0	VITE NO TESTA EI M6X6 TESTA PIANA INOX	6	PZ																																																		
VI1950A0	VITE AUTOFORANT E 4,2X13 TCB INOX	6	PZ																																																		
VM1224A0	TUBOLARE TERMORETR 65MY 220MM 2 COLORI	0.300	M																																																		
VM1680A0	CERNIERA APERTURA VETRO INTERNO	2	PZ																																																		
VM2042A0	ASSIEME CHIUSURA VETRO INTERNO LAT	2	PZ																																																		
VM2043A0	SUPPORTO VETRO SUP - INF	2	PZ																																																		
			KCR1086A	KIT CERNIERA VETRO INT INOX INF	<table border="1"> <thead> <tr> <th>Codice</th> <th>Descrizione</th> <th>Qtà</th> <th>UM</th> </tr> </thead> <tbody> <tr> <td>CR1086A0</td> <td>CERNIERA VETRO INT INOX INF</td> <td>1</td> <td>PZ</td> </tr> </tbody> </table>	Codice	Descrizione	Qtà	UM	CR1086A0	CERNIERA VETRO INT INOX INF	1	PZ																																								
Codice	Descrizione	Qtà	UM																																																		
CR1086A0	CERNIERA VETRO INT INOX INF	1	PZ																																																		

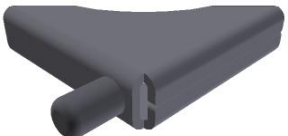
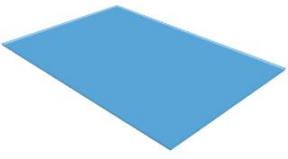
COMPONENTE			RICAMBIO																						
Codice	Descrizione	Immagine	Codice	Descrizione	Lista componenti																				
CR1086A	CERNIERA VETRO INT INOX INF		KCR1086A	KIT CERNIERA VETRO INT INOX INF	<table border="1"> <thead> <tr> <th>Codice</th> <th>Descrizione</th> <th>Qtà</th> <th>UM</th> </tr> </thead> <tbody> <tr> <td>GN1181A0</td> <td>GUARNIZIONE CERN VETRO INT CR1085-1086</td> <td>1</td> <td>PZ</td> </tr> <tr> <td>VI1810A0</td> <td>VITE NO TESTA EI M6X6 TESTA PIANA INOX</td> <td>3</td> <td>PZ</td> </tr> <tr> <td>VM1224A0</td> <td>TUBOLARE TERMORETR 65MY 220MM 2 COLORI</td> <td>0.200</td> <td>M</td> </tr> </tbody> </table>	Codice	Descrizione	Qtà	UM	GN1181A0	GUARNIZIONE CERN VETRO INT CR1085-1086	1	PZ	VI1810A0	VITE NO TESTA EI M6X6 TESTA PIANA INOX	3	PZ	VM1224A0	TUBOLARE TERMORETR 65MY 220MM 2 COLORI	0.200	M				
Codice	Descrizione	Qtà	UM																						
GN1181A0	GUARNIZIONE CERN VETRO INT CR1085-1086	1	PZ																						
VI1810A0	VITE NO TESTA EI M6X6 TESTA PIANA INOX	3	PZ																						
VM1224A0	TUBOLARE TERMORETR 65MY 220MM 2 COLORI	0.200	M																						
VT1095A	VETRO INTERNO 633X432X6 BETFL XVC304/305		KVT1095A	KIT VETRO INTERNO XL375/XV393/XVC30 4-305	<table border="1"> <thead> <tr> <th>Codice</th> <th>Descrizione</th> <th>Qtà</th> <th>UM</th> </tr> </thead> <tbody> <tr> <td>IP1508A1</td> <td>POLISTIROLO PROFILO AD U 2000X60X60</td> <td>2</td> <td>M</td> </tr> <tr> <td>VM1059A1</td> <td>FILM TERMORETRA IBILE H800</td> <td>1.500</td> <td>M</td> </tr> <tr> <td>VT1095A0</td> <td>VETRO INTERNO 633X432X6 BETFL XVC304/305</td> <td>1</td> <td>PZ</td> </tr> <tr> <td>VT1095A0</td> <td>VETRO INTERNO 633X432X6 BETFL XVC304/305</td> <td>1</td> <td>PZ</td> </tr> </tbody> </table>	Codice	Descrizione	Qtà	UM	IP1508A1	POLISTIROLO PROFILO AD U 2000X60X60	2	M	VM1059A1	FILM TERMORETRA IBILE H800	1.500	M	VT1095A0	VETRO INTERNO 633X432X6 BETFL XVC304/305	1	PZ	VT1095A0	VETRO INTERNO 633X432X6 BETFL XVC304/305	1	PZ
Codice	Descrizione	Qtà	UM																						
IP1508A1	POLISTIROLO PROFILO AD U 2000X60X60	2	M																						
VM1059A1	FILM TERMORETRA IBILE H800	1.500	M																						
VT1095A0	VETRO INTERNO 633X432X6 BETFL XVC304/305	1	PZ																						
VT1095A0	VETRO INTERNO 633X432X6 BETFL XVC304/305	1	PZ																						

ASM4102A/0.D00 - Assieme generico

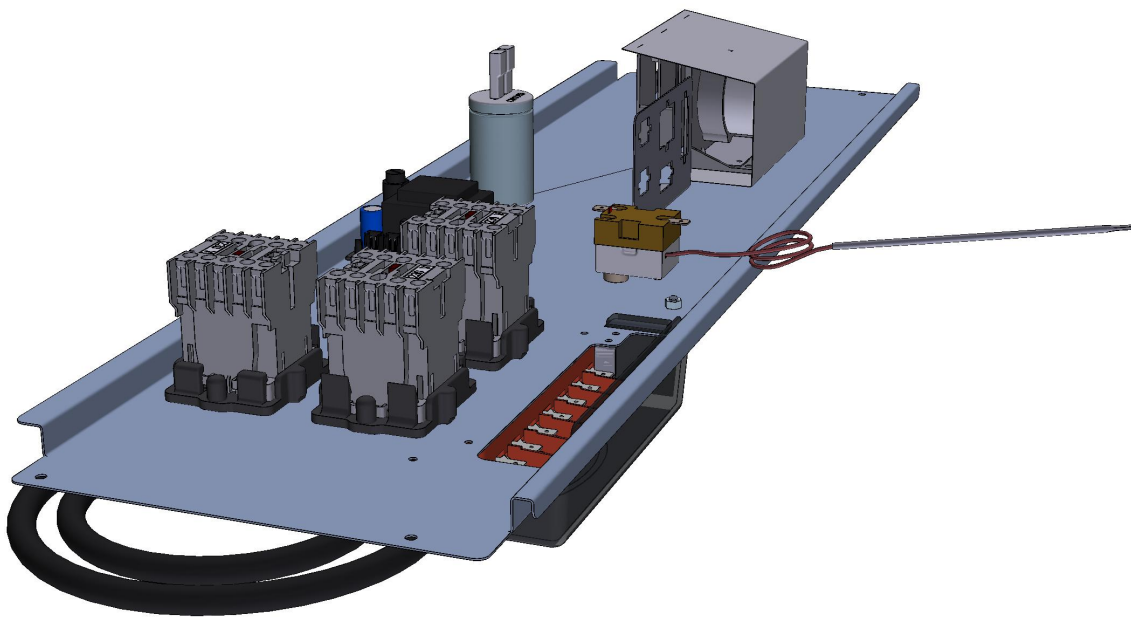

FRONTE





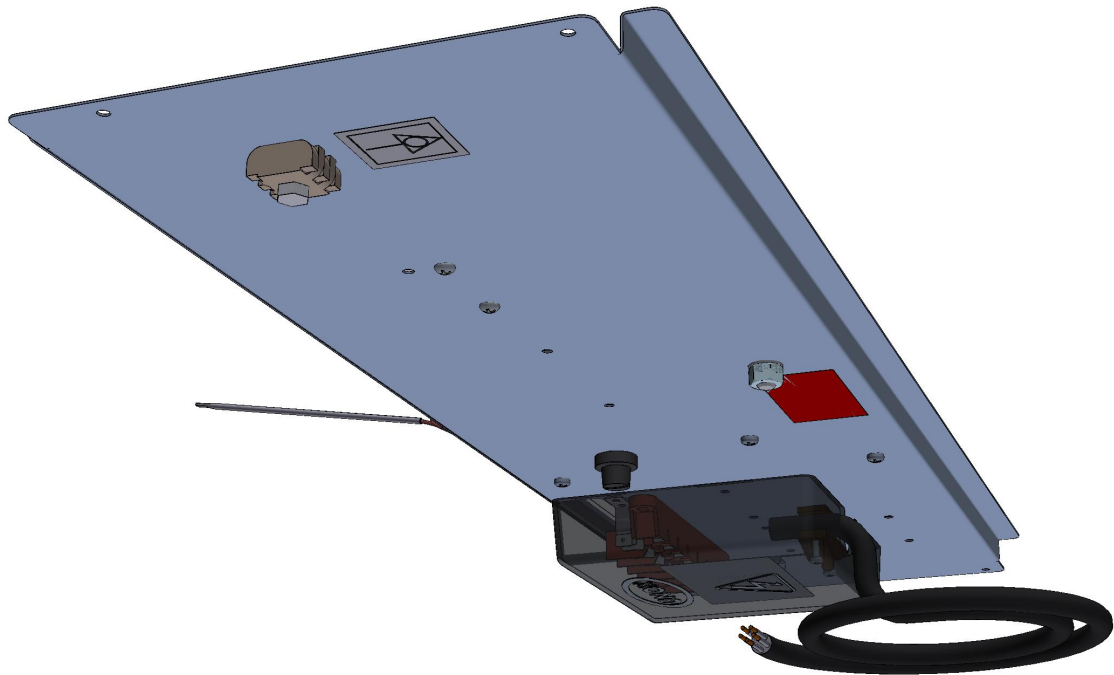

ASM4102A/0.D00 - Assieme generico

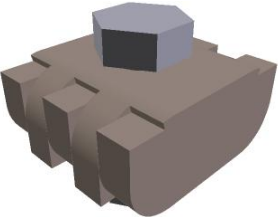
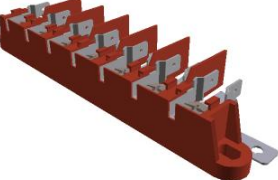
RETRO

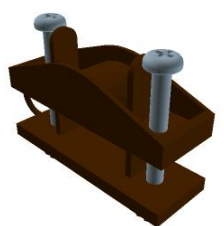

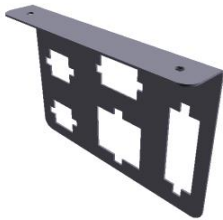
COMPONENTE			RICAMBIO																										
Codice	Descrizione	Immagine	Codice	Descrizione	Lista componenti																								
TR1136A	TERMOSTATO SIC. UNIP. 330°C		KTR1136A	KIT TERMOSTATO SICUREZZA 330°C	<table border="1"> <thead> <tr> <th>Codice</th> <th>Descrizione</th> <th>Qtà</th> <th>UM</th> </tr> </thead> <tbody> <tr> <td>0H7030A0</td> <td>COPERCHIO INGRESSO BULBO</td> <td>1</td> <td>PZ</td> </tr> <tr> <td>GN1531A0</td> <td>GUARNIZIONE TENUTA INGRESSO BULBO</td> <td>1</td> <td>PZ</td> </tr> <tr> <td>SL1045A0</td> <td>SILICONE ANTRACITE S57 80 ML</td> <td>1</td> <td>PZ</td> </tr> <tr> <td>TR1136A0</td> <td>TERMOSTATO SIC. UNIP. 330°C</td> <td>1</td> <td>PZ</td> </tr> <tr> <td>VI1220A1</td> <td>VITE AUTOFILETTA NTE 4.2X11 TCS+ MARUTE</td> <td>3</td> <td>PZ</td> </tr> </tbody> </table>	Codice	Descrizione	Qtà	UM	0H7030A0	COPERCHIO INGRESSO BULBO	1	PZ	GN1531A0	GUARNIZIONE TENUTA INGRESSO BULBO	1	PZ	SL1045A0	SILICONE ANTRACITE S57 80 ML	1	PZ	TR1136A0	TERMOSTATO SIC. UNIP. 330°C	1	PZ	VI1220A1	VITE AUTOFILETTA NTE 4.2X11 TCS+ MARUTE	3	PZ
Codice	Descrizione	Qtà	UM																										
0H7030A0	COPERCHIO INGRESSO BULBO	1	PZ																										
GN1531A0	GUARNIZIONE TENUTA INGRESSO BULBO	1	PZ																										
SL1045A0	SILICONE ANTRACITE S57 80 ML	1	PZ																										
TR1136A0	TERMOSTATO SIC. UNIP. 330°C	1	PZ																										
VI1220A1	VITE AUTOFILETTA NTE 4.2X11 TCS+ MARUTE	3	PZ																										
CN1003A	CONDENSATORE CORAZZATO 6,3 UF		KCN1003A	KIT CONDENSATORE MOTORE 6,3 UF	<table border="1"> <thead> <tr> <th>Codice</th> <th>Descrizione</th> <th>Qtà</th> <th>UM</th> </tr> </thead> <tbody> <tr> <td>CN1003A0</td> <td>CONDENSATO RE CORAZZATO 6,3 UF</td> <td>1</td> <td>PZ</td> </tr> <tr> <td>VI1931A0</td> <td>DADO M8X1.65 H4 CH13 ZINCATO</td> <td>1</td> <td>PZ</td> </tr> <tr> <td>VI1932A0</td> <td>RONDELLA DENTELLATA D8 ZINCATA</td> <td>1</td> <td>PZ</td> </tr> <tr> <td>VM1224A0</td> <td>TUBOLARE TERMORETR 65MY 220MM 2 COLORI</td> <td>0.200</td> <td>M</td> </tr> </tbody> </table>	Codice	Descrizione	Qtà	UM	CN1003A0	CONDENSATO RE CORAZZATO 6,3 UF	1	PZ	VI1931A0	DADO M8X1.65 H4 CH13 ZINCATO	1	PZ	VI1932A0	RONDELLA DENTELLATA D8 ZINCATA	1	PZ	VM1224A0	TUBOLARE TERMORETR 65MY 220MM 2 COLORI	0.200	M				
Codice	Descrizione	Qtà	UM																										
CN1003A0	CONDENSATO RE CORAZZATO 6,3 UF	1	PZ																										
VI1931A0	DADO M8X1.65 H4 CH13 ZINCATO	1	PZ																										
VI1932A0	RONDELLA DENTELLATA D8 ZINCATA	1	PZ																										
VM1224A0	TUBOLARE TERMORETR 65MY 220MM 2 COLORI	0.200	M																										
VM1750A	MORSETTO A PETTINE		KVM1750A	KIT MORSETTIERA A PETTINE	<table border="1"> <thead> <tr> <th>Codice</th> <th>Descrizione</th> <th>Qtà</th> <th>UM</th> </tr> </thead> <tbody> <tr> <td>VM1224A0</td> <td>TUBOLARE TERMORETR 65MY 220MM 2 COLORI</td> <td>0.150</td> <td>M</td> </tr> <tr> <td>VM1750A0</td> <td>MORSETTO A PETTINE</td> <td>1</td> <td>PZ</td> </tr> </tbody> </table>	Codice	Descrizione	Qtà	UM	VM1224A0	TUBOLARE TERMORETR 65MY 220MM 2 COLORI	0.150	M	VM1750A0	MORSETTO A PETTINE	1	PZ												
Codice	Descrizione	Qtà	UM																										
VM1224A0	TUBOLARE TERMORETR 65MY 220MM 2 COLORI	0.150	M																										
VM1750A0	MORSETTO A PETTINE	1	PZ																										
MR1004A	MORSETTIERA 7POLI 41A 450V		KMR1004A	KIT MORSETTIERA 7 POLI	<table border="1"> <thead> <tr> <th>Codice</th> <th>Descrizione</th> <th>Qtà</th> <th>UM</th> </tr> </thead> <tbody> <tr> <td>MR1004A1</td> <td>MORSETTIERA A 7POLI 41A 450V</td> <td>1</td> <td>PZ</td> </tr> <tr> <td>VM1224A0</td> <td>TUBOLARE TERMORETR 65MY 220MM 2 COLORI</td> <td>0.300</td> <td>M</td> </tr> </tbody> </table>	Codice	Descrizione	Qtà	UM	MR1004A1	MORSETTIERA A 7POLI 41A 450V	1	PZ	VM1224A0	TUBOLARE TERMORETR 65MY 220MM 2 COLORI	0.300	M												
Codice	Descrizione	Qtà	UM																										
MR1004A1	MORSETTIERA A 7POLI 41A 450V	1	PZ																										
VM1224A0	TUBOLARE TERMORETR 65MY 220MM 2 COLORI	0.300	M																										

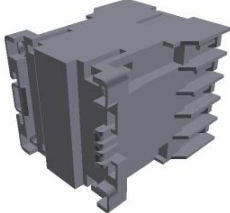
COMPONENTE			RICAMBIO																						
Codice	Descrizione	Immagine	Codice	Descrizione	Lista componenti																				
0H7293A	LAMIERINO MORSETTO TERRA		OUTOFPRODUCTIO	PRODOTTO OBSOLETO																					
VE1075A	PRESSACAVO DA PANNELLO PA6 UL94-V2		KVE1075A	KIT 10 PZ PRESSACAVO DA PANNELLO	<table border="1"> <thead> <tr> <th>Codice</th> <th>Descrizione</th> <th>Qtà</th> <th>UM</th> </tr> </thead> <tbody> <tr> <td>VE1075A0</td> <td>PRESSACAVO DA PANNELLO PA6 UL94-V2</td> <td>10</td> <td>PZ</td> </tr> <tr> <td>VM1224A0</td> <td>TUBOLARE TERMORETR 65MY 220MM 2 COLORI</td> <td>0.250</td> <td>M</td> </tr> </tbody> </table>	Codice	Descrizione	Qtà	UM	VE1075A0	PRESSACAVO DA PANNELLO PA6 UL94-V2	10	PZ	VM1224A0	TUBOLARE TERMORETR 65MY 220MM 2 COLORI	0.250	M								
Codice	Descrizione	Qtà	UM																						
VE1075A0	PRESSACAVO DA PANNELLO PA6 UL94-V2	10	PZ																						
VM1224A0	TUBOLARE TERMORETR 65MY 220MM 2 COLORI	0.250	M																						
CE1355A	CAVO 5X2,5MMQ H07RN-F L=1,5MT		KCE1355A	KIT CAVO 5X2.5 MMQ L1.5MT CE1355A1	<table border="1"> <thead> <tr> <th>Codice</th> <th>Descrizione</th> <th>Qtà</th> <th>UM</th> </tr> </thead> <tbody> <tr> <td>CE1355A1</td> <td>CAVO 5X2,5MMQ H07RN-F L=1,5MT</td> <td>1</td> <td>PZ</td> </tr> <tr> <td>VM1224A0</td> <td>TUBOLARE TERMORETR 65MY 220MM 2 COLORI</td> <td>0.350</td> <td>M</td> </tr> </tbody> </table>	Codice	Descrizione	Qtà	UM	CE1355A1	CAVO 5X2,5MMQ H07RN-F L=1,5MT	1	PZ	VM1224A0	TUBOLARE TERMORETR 65MY 220MM 2 COLORI	0.350	M								
Codice	Descrizione	Qtà	UM																						
CE1355A1	CAVO 5X2,5MMQ H07RN-F L=1,5MT	1	PZ																						
VM1224A0	TUBOLARE TERMORETR 65MY 220MM 2 COLORI	0.350	M																						
VM1310A	SCATOLA COPRI MORSETTIERA XB/XV/XVC/XG		VM1310A0	SCATOLA COPRI MORSETTIERA XB/XV/XVC/XG																					
VE1615A	INVERTITORE DI MARCIA		KVE1615A	KIT INVERTITORE MARCIA VE1615A	<table border="1"> <thead> <tr> <th>Codice</th> <th>Descrizione</th> <th>Qtà</th> <th>UM</th> </tr> </thead> <tbody> <tr> <td>0H1429A0</td> <td>LAMIERINO FISSAGGIO INVERTITORE VE1615A</td> <td>1</td> <td>PZ</td> </tr> <tr> <td>VE1615A0</td> <td>INVERTITORE DI MARCIA</td> <td>1</td> <td>PZ</td> </tr> <tr> <td>VI1960A0</td> <td>VITE AUTOFIL. 4.2X11 TCBS+ AISI410</td> <td>3</td> <td>PZ</td> </tr> <tr> <td>VI1960A1</td> <td>VITE AUTOFIL. 4.2X9.5 TCBS+ ZN-NI</td> <td>3</td> <td>PZ</td> </tr> </tbody> </table>	Codice	Descrizione	Qtà	UM	0H1429A0	LAMIERINO FISSAGGIO INVERTITORE VE1615A	1	PZ	VE1615A0	INVERTITORE DI MARCIA	1	PZ	VI1960A0	VITE AUTOFIL. 4.2X11 TCBS+ AISI410	3	PZ	VI1960A1	VITE AUTOFIL. 4.2X9.5 TCBS+ ZN-NI	3	PZ
Codice	Descrizione	Qtà	UM																						
0H1429A0	LAMIERINO FISSAGGIO INVERTITORE VE1615A	1	PZ																						
VE1615A0	INVERTITORE DI MARCIA	1	PZ																						
VI1960A0	VITE AUTOFIL. 4.2X11 TCBS+ AISI410	3	PZ																						
VI1960A1	VITE AUTOFIL. 4.2X9.5 TCBS+ ZN-NI	3	PZ																						

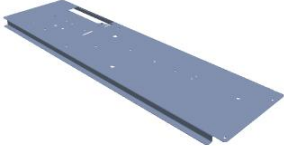
COMPONENTE			RICAMBIO																		
Codice	Descrizione	Immagine	Codice	Descrizione	Lista componenti																
0H6769A	LAMIERA FISSAGGIO CONNETTORI		0H6769B0	LAMIERA FISSAGGIO CONNETTORI																	
PE1782A	ALIMENTATORE 200-240VAC 12VCC 6VA		KPE1782A	KIT TRASF. 200-240VAC 12VCC BARRA LED	<table border="1"> <thead> <tr> <th>Codice</th> <th>Descrizione</th> <th>Qtà</th> <th>UM</th> </tr> </thead> <tbody> <tr> <td>PE1782A0</td> <td>ALIMENTATO RE 200-240VAC 12VCC 6VA</td> <td>1</td> <td>PZ</td> </tr> <tr> <td>VM1745A0</td> <td>SUPPORTO PER SCHEDA</td> <td>4</td> <td>PZ</td> </tr> <tr> <td>VM2147A0</td> <td>SPUGNA ESD ROSA LISCIA 410X343X15 M</td> <td>1</td> <td>PZ</td> </tr> </tbody> </table>	Codice	Descrizione	Qtà	UM	PE1782A0	ALIMENTATO RE 200-240VAC 12VCC 6VA	1	PZ	VM1745A0	SUPPORTO PER SCHEDA	4	PZ	VM2147A0	SPUGNA ESD ROSA LISCIA 410X343X15 M	1	PZ
Codice	Descrizione	Qtà	UM																		
PE1782A0	ALIMENTATO RE 200-240VAC 12VCC 6VA	1	PZ																		
VM1745A0	SUPPORTO PER SCHEDA	4	PZ																		
VM2147A0	SPUGNA ESD ROSA LISCIA 410X343X15 M	1	PZ																		
VE1115A	MINICONTATTORE QUADRIPOLORE 20 A 230V		KVE1115A	KIT MINICONTATTORE QUADRIPOLORE 20A 230V	<table border="1"> <thead> <tr> <th>Codice</th> <th>Descrizione</th> <th>Qtà</th> <th>UM</th> </tr> </thead> <tbody> <tr> <td>VE1115A0</td> <td>MINICONTATT ORE QUADRIPOLO RE 20 A 230V</td> <td>1</td> <td>PZ</td> </tr> <tr> <td>VM1075A1</td> <td>CLIP DI FISSAGGIO PER TELERUTTORI</td> <td>4</td> <td>PZ</td> </tr> <tr> <td>VM1224A0</td> <td>TUBOLARE TERMORETR 65MY 220MM 2 COLORI</td> <td>0.250</td> <td>M</td> </tr> </tbody> </table>	Codice	Descrizione	Qtà	UM	VE1115A0	MINICONTATT ORE QUADRIPOLO RE 20 A 230V	1	PZ	VM1075A1	CLIP DI FISSAGGIO PER TELERUTTORI	4	PZ	VM1224A0	TUBOLARE TERMORETR 65MY 220MM 2 COLORI	0.250	M
Codice	Descrizione	Qtà	UM																		
VE1115A0	MINICONTATT ORE QUADRIPOLO RE 20 A 230V	1	PZ																		
VM1075A1	CLIP DI FISSAGGIO PER TELERUTTORI	4	PZ																		
VM1224A0	TUBOLARE TERMORETR 65MY 220MM 2 COLORI	0.250	M																		
VM1056A	STAFFA TELERUTTORE PICCOLO VE1115A		VM1056A0	STAFFA TELERUTTORE PICCOLO VE1115A																	
0H7141B	PORTACOMPONEN TI CHEFLUX XV393		0H7141B0	PORTACOMPONEN TI CHEFLUX XV393																	