







Codice assieme	Descrizione assieme	Immagine assieme
ASM2749B/0.D00	Camera di cottura	
ASM2750A/0.D00	Copertura esterna	
ASM4098A/0.D00	Impianto elettrico	
ASM4079A/0.D00	Porta	

ASM2749B/0.D00 - Camera di cottura

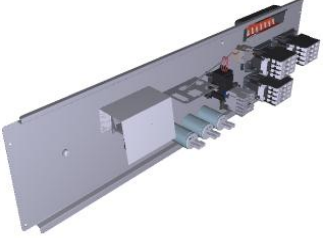
FRONTE

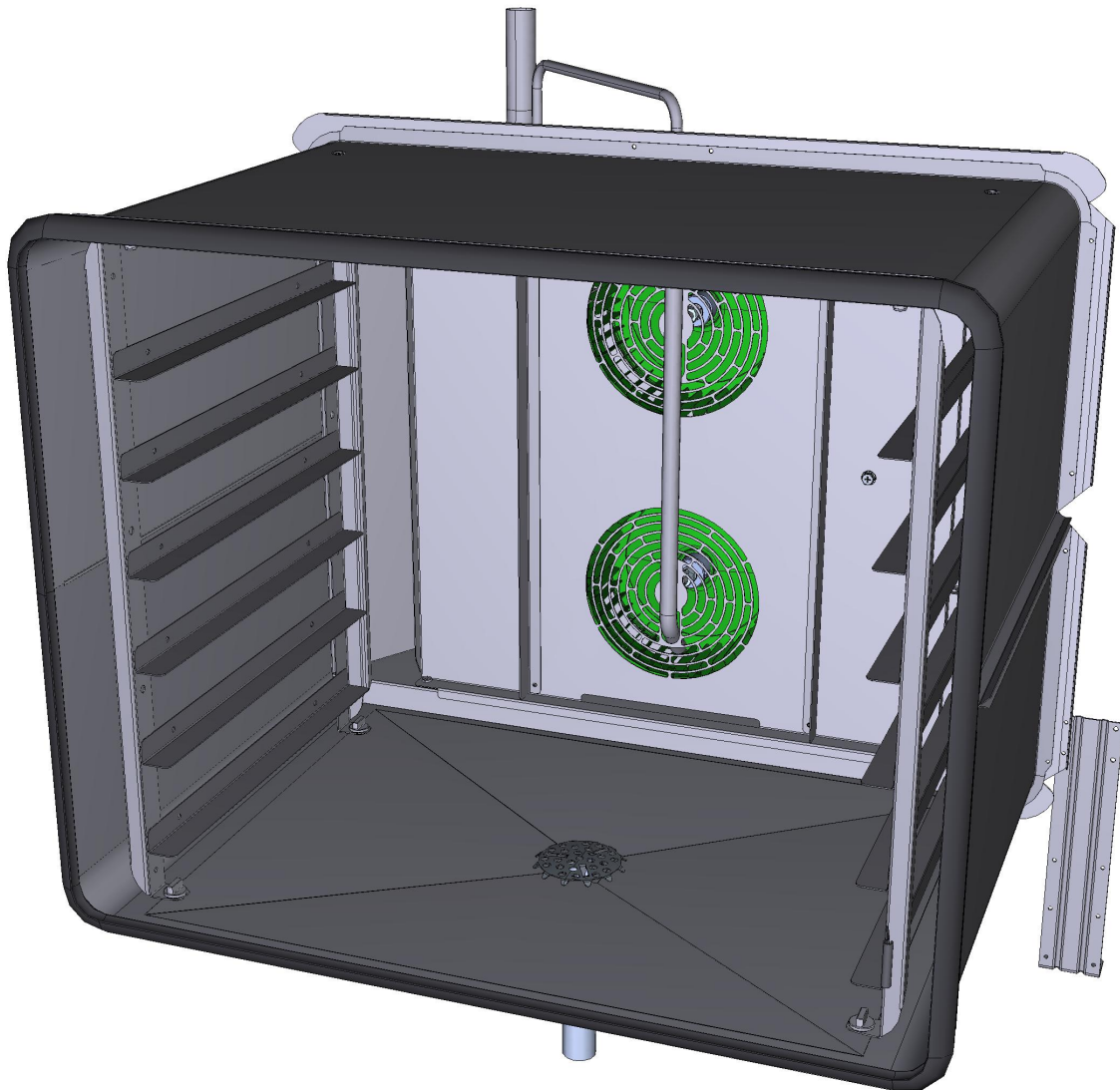

ASM2749B/0.D00 - Camera di cottura

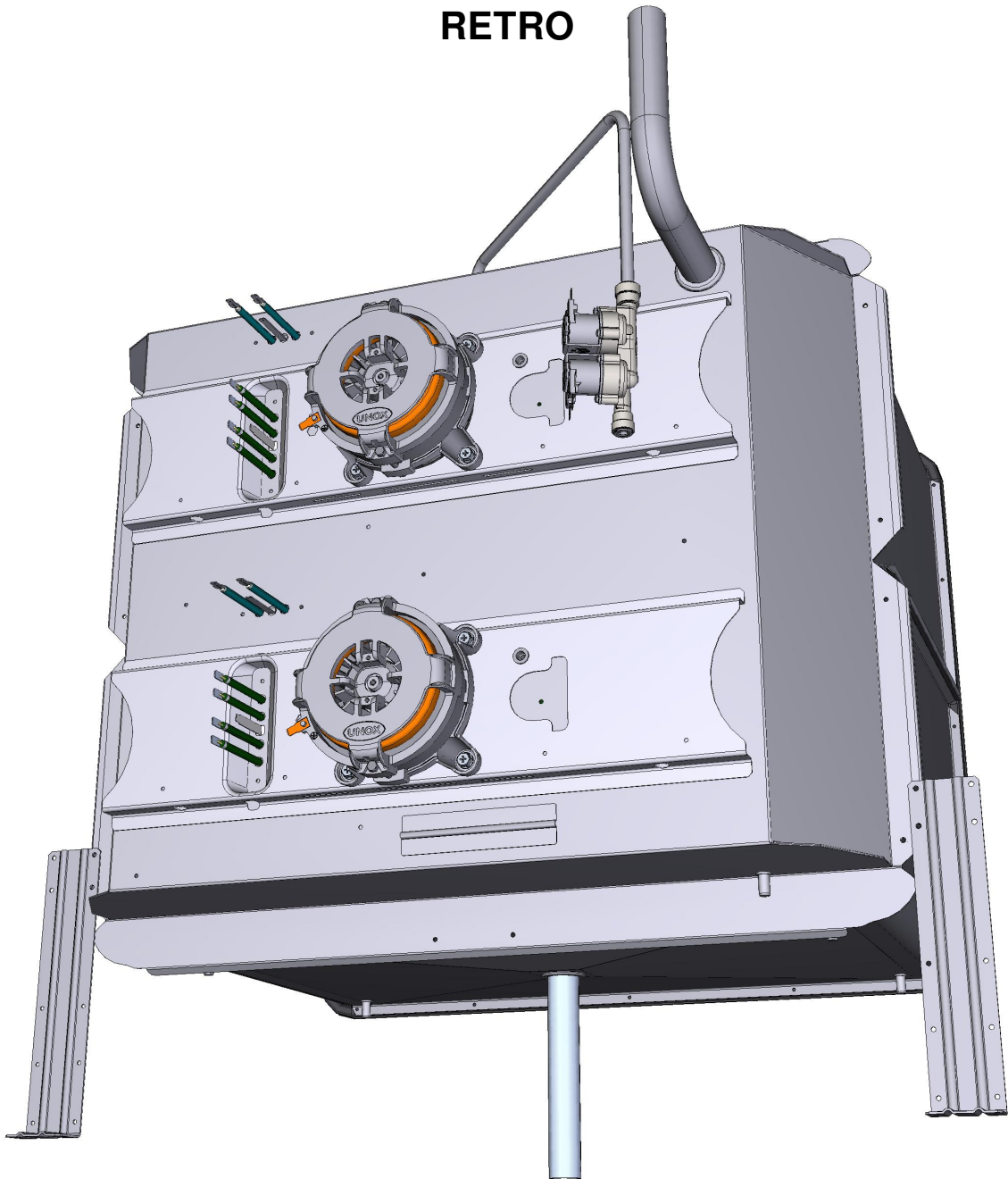

RETRO

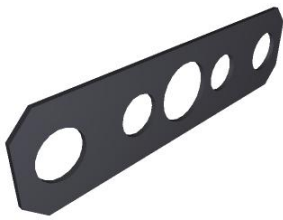

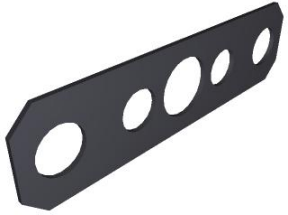

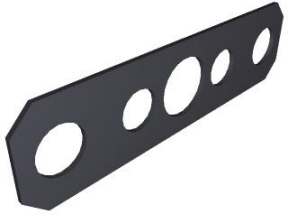
COMPONENTE			RICAMBIO																											
Codice	Descrizione	Immagine	Codice	Descrizione	Lista componenti																									
GN1326A	GUARNIZIONE RESISTENZA 71X19 G6.25		KRS1261A	KIT RESISTENZA FRENATA 122W	<table border="1"> <thead> <tr> <th>Codice</th> <th>Descrizione</th> <th>Qtà</th> <th>UM</th> </tr> </thead> <tbody> <tr> <td>SL1045A0</td> <td>SILICONE ANTRACITE S57 80 ML</td> <td>1</td> <td>PZ</td> </tr> <tr> <td>VI1220A1</td> <td>VITE AUTOFIILETTA NTE 4.2X11 TCS+ MARUTE</td> <td>2</td> <td>PZ</td> </tr> <tr> <td>VM2147A0</td> <td>SPUGNA ESD ROSA LISCIA 410X343X15 M</td> <td>1</td> <td>PZ</td> </tr> </tbody> </table>	Codice	Descrizione	Qtà	UM	SL1045A0	SILICONE ANTRACITE S57 80 ML	1	PZ	VI1220A1	VITE AUTOFIILETTA NTE 4.2X11 TCS+ MARUTE	2	PZ	VM2147A0	SPUGNA ESD ROSA LISCIA 410X343X15 M	1	PZ									
			Codice	Descrizione	Qtà	UM																								
			SL1045A0	SILICONE ANTRACITE S57 80 ML	1	PZ																								
			VI1220A1	VITE AUTOFIILETTA NTE 4.2X11 TCS+ MARUTE	2	PZ																								
VM2147A0	SPUGNA ESD ROSA LISCIA 410X343X15 M	1	PZ																											
KRS1215A	KIT RESISTENZA FRENATA 147W	<table border="1"> <thead> <tr> <th>Codice</th> <th>Descrizione</th> <th>Qtà</th> <th>UM</th> </tr> </thead> <tbody> <tr> <td>GN1326A1</td> <td>GUARNIZIONE RESISTENZA 71X19 G6.25</td> <td>1</td> <td>PZ</td> </tr> <tr> <td>RS1215A1</td> <td>RESISTENZA FRENATA 147W 105V 1 SPIRA</td> <td>1</td> <td>PZ</td> </tr> <tr> <td>SL1045A0</td> <td>SILICONE ANTRACITE S57 80 ML</td> <td>1</td> <td>PZ</td> </tr> <tr> <td>VI1220A1</td> <td>VITE AUTOFIILETTA NTE 4.2X11 TCS+ MARUTE</td> <td>2</td> <td>PZ</td> </tr> </tbody> </table>	Codice	Descrizione	Qtà	UM	GN1326A1	GUARNIZIONE RESISTENZA 71X19 G6.25	1	PZ	RS1215A1	RESISTENZA FRENATA 147W 105V 1 SPIRA	1	PZ	SL1045A0	SILICONE ANTRACITE S57 80 ML	1	PZ	VI1220A1	VITE AUTOFIILETTA NTE 4.2X11 TCS+ MARUTE	2	PZ								
Codice	Descrizione	Qtà	UM																											
GN1326A1	GUARNIZIONE RESISTENZA 71X19 G6.25	1	PZ																											
RS1215A1	RESISTENZA FRENATA 147W 105V 1 SPIRA	1	PZ																											
SL1045A0	SILICONE ANTRACITE S57 80 ML	1	PZ																											
VI1220A1	VITE AUTOFIILETTA NTE 4.2X11 TCS+ MARUTE	2	PZ																											
KRS1095A	KIT RESISTENZA 1.2KW	<table border="1"> <thead> <tr> <th>Codice</th> <th>Descrizione</th> <th>Qtà</th> <th>UM</th> </tr> </thead> <tbody> <tr> <td>GN1326A1</td> <td>GUARNIZIONE RESISTENZA 71X19 G6.25</td> <td>1</td> <td>PZ</td> </tr> <tr> <td>IP1385A1</td> <td>IMB POL ANGOLARE 110X80X2000 D30</td> <td>0.500</td> <td>M</td> </tr> <tr> <td>RS1095A1</td> <td>RESISTENZA PIANA 1200W 230V</td> <td>1</td> <td>PZ</td> </tr> <tr> <td>SL1045A0</td> <td>SILICONE ANTRACITE S57 80 ML</td> <td>1</td> <td>PZ</td> </tr> <tr> <td>VI1220A1</td> <td>VITE AUTOFIILETTA NTE 4.2X11 TCS+ MARUTE</td> <td>2</td> <td>PZ</td> </tr> <tr> <td>VM1059A1</td> <td>FILM TERMORETRA IBILE H800</td> <td>1.200</td> <td>M</td> </tr> </tbody> </table>	Codice	Descrizione	Qtà	UM	GN1326A1	GUARNIZIONE RESISTENZA 71X19 G6.25	1	PZ	IP1385A1	IMB POL ANGOLARE 110X80X2000 D30	0.500	M	RS1095A1	RESISTENZA PIANA 1200W 230V	1	PZ	SL1045A0	SILICONE ANTRACITE S57 80 ML	1	PZ	VI1220A1	VITE AUTOFIILETTA NTE 4.2X11 TCS+ MARUTE	2	PZ	VM1059A1	FILM TERMORETRA IBILE H800	1.200	M
Codice	Descrizione	Qtà	UM																											
GN1326A1	GUARNIZIONE RESISTENZA 71X19 G6.25	1	PZ																											
IP1385A1	IMB POL ANGOLARE 110X80X2000 D30	0.500	M																											
RS1095A1	RESISTENZA PIANA 1200W 230V	1	PZ																											
SL1045A0	SILICONE ANTRACITE S57 80 ML	1	PZ																											
VI1220A1	VITE AUTOFIILETTA NTE 4.2X11 TCS+ MARUTE	2	PZ																											
VM1059A1	FILM TERMORETRA IBILE H800	1.200	M																											
KRS1012A	KIT RESISTENZA 1365W 120V	<table border="1"> <thead> <tr> <th>Codice</th> <th>Descrizione</th> <th>Qtà</th> <th>UM</th> </tr> </thead> <tbody> <tr> <td>GN1326A1</td> <td>GUARNIZIONE RESISTENZA 71X19 G6.25</td> <td>1</td> <td>PZ</td> </tr> </tbody> </table>	Codice	Descrizione	Qtà	UM	GN1326A1	GUARNIZIONE RESISTENZA 71X19 G6.25	1	PZ																				
Codice	Descrizione	Qtà	UM																											
GN1326A1	GUARNIZIONE RESISTENZA 71X19 G6.25	1	PZ																											

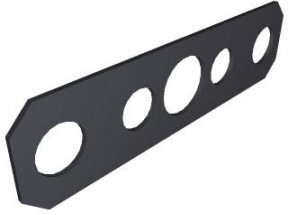

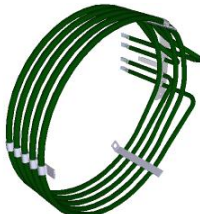
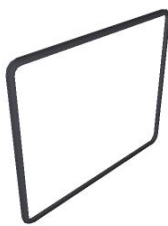

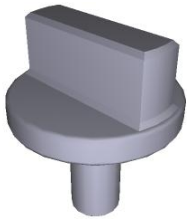
COMPONENTE			RICAMBIO																											
Codice	Descrizione	Immagine	Codice	Descrizione	Lista componenti																									
GN1326A	GUARNIZIONE RESISTENZA 71X19 G6.25		KRS1012A	KIT RESISTENZA 1365W 120V	<table border="1"> <thead> <tr> <th>Codice</th> <th>Descrizione</th> <th>Qtà</th> <th>UM</th> </tr> </thead> <tbody> <tr> <td>RS1012A0</td> <td>RESISTENZA CIRCOLARE 1365W 120V</td> <td>1</td> <td>PZ</td> </tr> <tr> <td>VI1220A1</td> <td>VITE AUTOFILETTA NTE 4.2X11 TCS+ MARUTE</td> <td>5</td> <td>PZ</td> </tr> <tr> <td>VM1794A0</td> <td>FASCETTA 430X4.8 PA66 NERA</td> <td>2</td> <td>PZ</td> </tr> <tr> <td>VM2103A0</td> <td>PIASTRINA FERMAFASCE TTA</td> <td>2</td> <td>PZ</td> </tr> </tbody> </table>	Codice	Descrizione	Qtà	UM	RS1012A0	RESISTENZA CIRCOLARE 1365W 120V	1	PZ	VI1220A1	VITE AUTOFILETTA NTE 4.2X11 TCS+ MARUTE	5	PZ	VM1794A0	FASCETTA 430X4.8 PA66 NERA	2	PZ	VM2103A0	PIASTRINA FERMAFASCE TTA	2	PZ					
			Codice	Descrizione	Qtà	UM																								
			RS1012A0	RESISTENZA CIRCOLARE 1365W 120V	1	PZ																								
VI1220A1	VITE AUTOFILETTA NTE 4.2X11 TCS+ MARUTE	5	PZ																											
VM1794A0	FASCETTA 430X4.8 PA66 NERA	2	PZ																											
VM2103A0	PIASTRINA FERMAFASCE TTA	2	PZ																											
KRS1011A	KIT RESISTENZA ROBERTA/LISA	<table border="1"> <thead> <tr> <th>Codice</th> <th>Descrizione</th> <th>Qtà</th> <th>UM</th> </tr> </thead> <tbody> <tr> <td>GN1326A1</td> <td>GUARNIZIONE RESISTENZA 71X19 G6.25</td> <td>1</td> <td>PZ</td> </tr> <tr> <td>RS1011A0</td> <td>RESISTENZA CIRCOLARE 2560W 220-230</td> <td>1</td> <td>PZ</td> </tr> <tr> <td>SL1045A0</td> <td>SILICONE ANTRACITE S57 80 ML</td> <td>1</td> <td>PZ</td> </tr> <tr> <td>VI1220A1</td> <td>VITE AUTOFILETTA NTE 4.2X11 TCS+ MARUTE</td> <td>5</td> <td>PZ</td> </tr> <tr> <td>VM1794A0</td> <td>FASCETTA 430X4.8 PA66 NERA</td> <td>2</td> <td>PZ</td> </tr> <tr> <td>VM2103A0</td> <td>PIASTRINA FERMAFASCE TTA</td> <td>2</td> <td>PZ</td> </tr> </tbody> </table>	Codice	Descrizione	Qtà	UM	GN1326A1	GUARNIZIONE RESISTENZA 71X19 G6.25	1	PZ	RS1011A0	RESISTENZA CIRCOLARE 2560W 220-230	1	PZ	SL1045A0	SILICONE ANTRACITE S57 80 ML	1	PZ	VI1220A1	VITE AUTOFILETTA NTE 4.2X11 TCS+ MARUTE	5	PZ	VM1794A0	FASCETTA 430X4.8 PA66 NERA	2	PZ	VM2103A0	PIASTRINA FERMAFASCE TTA	2	PZ
Codice	Descrizione	Qtà	UM																											
GN1326A1	GUARNIZIONE RESISTENZA 71X19 G6.25	1	PZ																											
RS1011A0	RESISTENZA CIRCOLARE 2560W 220-230	1	PZ																											
SL1045A0	SILICONE ANTRACITE S57 80 ML	1	PZ																											
VI1220A1	VITE AUTOFILETTA NTE 4.2X11 TCS+ MARUTE	5	PZ																											
VM1794A0	FASCETTA 430X4.8 PA66 NERA	2	PZ																											
VM2103A0	PIASTRINA FERMAFASCE TTA	2	PZ																											
KRS0090A	KIT RESISTENZA 1.26KW	<table border="1"> <thead> <tr> <th>Codice</th> <th>Descrizione</th> <th>Qtà</th> <th>UM</th> </tr> </thead> <tbody> <tr> <td>GN1326A1</td> <td>GUARNIZIONE RESISTENZA 71X19 G6.25</td> <td>1</td> <td>PZ</td> </tr> <tr> <td>RS0090A0</td> <td>RESISTENZA CIRCOLARE 1260W 220-230</td> <td>1</td> <td>PZ</td> </tr> <tr> <td>VI1220A1</td> <td>VITE AUTOFILETTA NTE 4.2X11 TCS+ MARUTE</td> <td>3</td> <td>PZ</td> </tr> <tr> <td>VM1794A0</td> <td>FASCETTA 430X4.8 PA66 NERA</td> <td>2</td> <td>PZ</td> </tr> <tr> <td>VM2103A0</td> <td>PIASTRINA FERMAFASCE TTA</td> <td>2</td> <td>PZ</td> </tr> </tbody> </table>	Codice	Descrizione	Qtà	UM	GN1326A1	GUARNIZIONE RESISTENZA 71X19 G6.25	1	PZ	RS0090A0	RESISTENZA CIRCOLARE 1260W 220-230	1	PZ	VI1220A1	VITE AUTOFILETTA NTE 4.2X11 TCS+ MARUTE	3	PZ	VM1794A0	FASCETTA 430X4.8 PA66 NERA	2	PZ	VM2103A0	PIASTRINA FERMAFASCE TTA	2	PZ				
Codice	Descrizione	Qtà	UM																											
GN1326A1	GUARNIZIONE RESISTENZA 71X19 G6.25	1	PZ																											
RS0090A0	RESISTENZA CIRCOLARE 1260W 220-230	1	PZ																											
VI1220A1	VITE AUTOFILETTA NTE 4.2X11 TCS+ MARUTE	3	PZ																											
VM1794A0	FASCETTA 430X4.8 PA66 NERA	2	PZ																											
VM2103A0	PIASTRINA FERMAFASCE TTA	2	PZ																											

COMPONENTE			RICAMBIO																										
Codice	Descrizione	Immagine	Codice	Descrizione	Lista componenti																								
GN1326A	GUARNIZIONE RESISTENZA 71X19 G6.25		KRS0050A	KIT RESISTENZA 0.5KW	<table border="1"> <thead> <tr> <th>Codice</th> <th>Descrizione</th> <th>Qtà</th> <th>UM</th> </tr> </thead> <tbody> <tr> <td>GN1326A1</td> <td>GUARNIZIONE RESISTENZA 71X19 G6.25</td> <td>1</td> <td>PZ</td> </tr> <tr> <td>IP1075A1</td> <td>IMB POL 70X150X765 D=10 CON PRETAGLIO</td> <td>1</td> <td>PZ</td> </tr> <tr> <td>IP1080A1</td> <td>IMB POL 280X255X10 D=10</td> <td>1</td> <td>PZ</td> </tr> <tr> <td>RS0050A0</td> <td>RESISTENZA PIANA 500W 220-230V</td> <td>1</td> <td>PZ</td> </tr> <tr> <td>VI1220A1</td> <td>VITE AUTOFILETTA NTE 4.2X11 TCS+ MARUTE</td> <td>2</td> <td>PZ</td> </tr> </tbody> </table>	Codice	Descrizione	Qtà	UM	GN1326A1	GUARNIZIONE RESISTENZA 71X19 G6.25	1	PZ	IP1075A1	IMB POL 70X150X765 D=10 CON PRETAGLIO	1	PZ	IP1080A1	IMB POL 280X255X10 D=10	1	PZ	RS0050A0	RESISTENZA PIANA 500W 220-230V	1	PZ	VI1220A1	VITE AUTOFILETTA NTE 4.2X11 TCS+ MARUTE	2	PZ
			Codice	Descrizione	Qtà	UM																							
			GN1326A1	GUARNIZIONE RESISTENZA 71X19 G6.25	1	PZ																							
IP1075A1	IMB POL 70X150X765 D=10 CON PRETAGLIO	1	PZ																										
IP1080A1	IMB POL 280X255X10 D=10	1	PZ																										
RS0050A0	RESISTENZA PIANA 500W 220-230V	1	PZ																										
VI1220A1	VITE AUTOFILETTA NTE 4.2X11 TCS+ MARUTE	2	PZ																										
KRS0011A	KIT RESISTENZA 1.465KW RS0011A	<table border="1"> <thead> <tr> <th>Codice</th> <th>Descrizione</th> <th>Qtà</th> <th>UM</th> </tr> </thead> <tbody> <tr> <td>GN1326A1</td> <td>GUARNIZIONE RESISTENZA 71X19 G6.25</td> <td>1</td> <td>PZ</td> </tr> <tr> <td>RS0011A0</td> <td>RESISTENZA CIRCOLARE 1465W 220-230</td> <td>1</td> <td>PZ</td> </tr> <tr> <td>VI1220A1</td> <td>VITE AUTOFILETTA NTE 4.2X11 TCS+ MARUTE</td> <td>3</td> <td>PZ</td> </tr> <tr> <td>VM1794A0</td> <td>FASCETTA 430X4.8 PA66 NERA</td> <td>2</td> <td>PZ</td> </tr> <tr> <td>VM2103A0</td> <td>PIASTRINA FERMAFASCE TTA</td> <td>2</td> <td>PZ</td> </tr> </tbody> </table>	Codice	Descrizione	Qtà	UM	GN1326A1	GUARNIZIONE RESISTENZA 71X19 G6.25	1	PZ	RS0011A0	RESISTENZA CIRCOLARE 1465W 220-230	1	PZ	VI1220A1	VITE AUTOFILETTA NTE 4.2X11 TCS+ MARUTE	3	PZ	VM1794A0	FASCETTA 430X4.8 PA66 NERA	2	PZ	VM2103A0	PIASTRINA FERMAFASCE TTA	2	PZ			
Codice	Descrizione	Qtà	UM																										
GN1326A1	GUARNIZIONE RESISTENZA 71X19 G6.25	1	PZ																										
RS0011A0	RESISTENZA CIRCOLARE 1465W 220-230	1	PZ																										
VI1220A1	VITE AUTOFILETTA NTE 4.2X11 TCS+ MARUTE	3	PZ																										
VM1794A0	FASCETTA 430X4.8 PA66 NERA	2	PZ																										
VM2103A0	PIASTRINA FERMAFASCE TTA	2	PZ																										
KRS0010A	KIT RESISTENZA RS0010A	<table border="1"> <thead> <tr> <th>Codice</th> <th>Descrizione</th> <th>Qtà</th> <th>UM</th> </tr> </thead> <tbody> <tr> <td>GN1326A1</td> <td>GUARNIZIONE RESISTENZA 71X19 G6.25</td> <td>1</td> <td>PZ</td> </tr> <tr> <td>IP1075A1</td> <td>IMB POL 70X150X765 D=10 CON PRETAGLIO</td> <td>1</td> <td>PZ</td> </tr> <tr> <td>IP1080A1</td> <td>IMB POL 280X255X10 D=10</td> <td>5</td> <td>PZ</td> </tr> <tr> <td>RS0010A0</td> <td>RESISTENZA CIRCOLARE 2560W 220-230</td> <td>1</td> <td>PZ</td> </tr> <tr> <td>VI1220A1</td> <td>VITE AUTOFILETTA NTE 4.2X11 TCS+ MARUTE</td> <td>3</td> <td>PZ</td> </tr> </tbody> </table>	Codice	Descrizione	Qtà	UM	GN1326A1	GUARNIZIONE RESISTENZA 71X19 G6.25	1	PZ	IP1075A1	IMB POL 70X150X765 D=10 CON PRETAGLIO	1	PZ	IP1080A1	IMB POL 280X255X10 D=10	5	PZ	RS0010A0	RESISTENZA CIRCOLARE 2560W 220-230	1	PZ	VI1220A1	VITE AUTOFILETTA NTE 4.2X11 TCS+ MARUTE	3	PZ			
Codice	Descrizione	Qtà	UM																										
GN1326A1	GUARNIZIONE RESISTENZA 71X19 G6.25	1	PZ																										
IP1075A1	IMB POL 70X150X765 D=10 CON PRETAGLIO	1	PZ																										
IP1080A1	IMB POL 280X255X10 D=10	5	PZ																										
RS0010A0	RESISTENZA CIRCOLARE 2560W 220-230	1	PZ																										
VI1220A1	VITE AUTOFILETTA NTE 4.2X11 TCS+ MARUTE	3	PZ																										

COMPONENTE			RICAMBIO																														
Codice	Descrizione	Immagine	Codice	Descrizione	Lista componenti																												
GN1326A	GUARNIZIONE RESISTENZA 71X19 G6.25		KG1326A	KIT 5 PZ GUARNIZIONE RESISTENZA	<table border="1"> <thead> <tr> <th>Codice</th> <th>Descrizione</th> <th>Qtà</th> <th>UM</th> </tr> </thead> <tbody> <tr> <td>GN1326A1</td> <td>GUARNIZIONE RESISTENZA 71X19 G6.25</td> <td>5</td> <td>PZ</td> </tr> <tr> <td>VM1224A0</td> <td>TUBOLARE TERMORETR 65MY 220MM 2 COLORI</td> <td>0.200</td> <td>M</td> </tr> </tbody> </table>	Codice	Descrizione	Qtà	UM	GN1326A1	GUARNIZIONE RESISTENZA 71X19 G6.25	5	PZ	VM1224A0	TUBOLARE TERMORETR 65MY 220MM 2 COLORI	0.200	M																
Codice	Descrizione	Qtà	UM																														
GN1326A1	GUARNIZIONE RESISTENZA 71X19 G6.25	5	PZ																														
VM1224A0	TUBOLARE TERMORETR 65MY 220MM 2 COLORI	0.200	M																														
EL1361A	ELETTROVALVOLA VAPORE J.G. D8-D10		KEL1361A	KIT ELETTROVALVOLA VAPORE D8-D10	<table border="1"> <thead> <tr> <th>Codice</th> <th>Descrizione</th> <th>Qtà</th> <th>UM</th> </tr> </thead> <tbody> <tr> <td>EL1361A0</td> <td>ELETTROVALV OLA VAPORE J.G. D8-D10</td> <td>1</td> <td>PZ</td> </tr> <tr> <td>VM1224A0</td> <td>TUBOLARE TERMORETR 65MY 220MM 2 COLORI</td> <td>0.250</td> <td>M</td> </tr> </tbody> </table>	Codice	Descrizione	Qtà	UM	EL1361A0	ELETTROVALV OLA VAPORE J.G. D8-D10	1	PZ	VM1224A0	TUBOLARE TERMORETR 65MY 220MM 2 COLORI	0.250	M																
Codice	Descrizione	Qtà	UM																														
EL1361A0	ELETTROVALV OLA VAPORE J.G. D8-D10	1	PZ																														
VM1224A0	TUBOLARE TERMORETR 65MY 220MM 2 COLORI	0.250	M																														
RS1150A	RESISTENZA CIRCOLARE 4,9KW D=230 5 SPIRE		KRS1150A	KIT RESISTENZA 4,9KW	<table border="1"> <thead> <tr> <th>Codice</th> <th>Descrizione</th> <th>Qtà</th> <th>UM</th> </tr> </thead> <tbody> <tr> <td>GN1327A0</td> <td>GUARNIZIONE RESISTENZA 100X22</td> <td>1</td> <td>PZ</td> </tr> <tr> <td>RS1150A0</td> <td>RESISTENZA CIRCOLARE 4,9KW D=230 5 SPIRE</td> <td>1</td> <td>PZ</td> </tr> <tr> <td>SL1045A0</td> <td>SILICONE ANTRACITE S57 80 ML</td> <td>1</td> <td>PZ</td> </tr> <tr> <td>VI1220A1</td> <td>VITE AUTOFILETTA NTE 4.2X11 TCS+ MARUTE</td> <td>5</td> <td>PZ</td> </tr> <tr> <td>VM1794A0</td> <td>FASCETTA 430X4.8 PA66 NERA</td> <td>2</td> <td>PZ</td> </tr> <tr> <td>VM2103A0</td> <td>PIASTRINA FERMAFASCE TTA</td> <td>2</td> <td>PZ</td> </tr> </tbody> </table>	Codice	Descrizione	Qtà	UM	GN1327A0	GUARNIZIONE RESISTENZA 100X22	1	PZ	RS1150A0	RESISTENZA CIRCOLARE 4,9KW D=230 5 SPIRE	1	PZ	SL1045A0	SILICONE ANTRACITE S57 80 ML	1	PZ	VI1220A1	VITE AUTOFILETTA NTE 4.2X11 TCS+ MARUTE	5	PZ	VM1794A0	FASCETTA 430X4.8 PA66 NERA	2	PZ	VM2103A0	PIASTRINA FERMAFASCE TTA	2	PZ
Codice	Descrizione	Qtà	UM																														
GN1327A0	GUARNIZIONE RESISTENZA 100X22	1	PZ																														
RS1150A0	RESISTENZA CIRCOLARE 4,9KW D=230 5 SPIRE	1	PZ																														
SL1045A0	SILICONE ANTRACITE S57 80 ML	1	PZ																														
VI1220A1	VITE AUTOFILETTA NTE 4.2X11 TCS+ MARUTE	5	PZ																														
VM1794A0	FASCETTA 430X4.8 PA66 NERA	2	PZ																														
VM2103A0	PIASTRINA FERMAFASCE TTA	2	PZ																														
GN1342C	GN1006A - GUARNIZIONE PORTA XBC605E		KG1663A	KIT GUARN. PORTA SERIE 600 TOP/LUX-XV500	<table border="1"> <thead> <tr> <th>Codice</th> <th>Descrizione</th> <th>Qtà</th> <th>UM</th> </tr> </thead> <tbody> <tr> <td>GN1626A0</td> <td>GUARNIZIONE FACCIATA DOPPIO LABBRO</td> <td>2.510</td> <td>M</td> </tr> <tr> <td>SL1025A0</td> <td>TUBETTO SIL.90ML DOW CORNING 734 CLEAR</td> <td>0.012</td> <td>PZ</td> </tr> <tr> <td>VM1224A0</td> <td>TUBOLARE TERMORETR 65MY 220MM 2 COLORI</td> <td>0.400</td> <td>M</td> </tr> <tr> <td>VM2277A0</td> <td>SPINA KIT GUARNIZIONE PORTA</td> <td>1</td> <td>PZ</td> </tr> </tbody> </table>	Codice	Descrizione	Qtà	UM	GN1626A0	GUARNIZIONE FACCIATA DOPPIO LABBRO	2.510	M	SL1025A0	TUBETTO SIL.90ML DOW CORNING 734 CLEAR	0.012	PZ	VM1224A0	TUBOLARE TERMORETR 65MY 220MM 2 COLORI	0.400	M	VM2277A0	SPINA KIT GUARNIZIONE PORTA	1	PZ								
Codice	Descrizione	Qtà	UM																														
GN1626A0	GUARNIZIONE FACCIATA DOPPIO LABBRO	2.510	M																														
SL1025A0	TUBETTO SIL.90ML DOW CORNING 734 CLEAR	0.012	PZ																														
VM1224A0	TUBOLARE TERMORETR 65MY 220MM 2 COLORI	0.400	M																														
VM2277A0	SPINA KIT GUARNIZIONE PORTA	1	PZ																														

COMPONENTE			RICAMBIO																										
Codice	Descrizione	Immagine	Codice	Descrizione	Lista componenti																								
VM1820A	NOTTOLINO M6 CROMATO FISS. SUPPORTI		KVM1820A	KIT 10 NOTTOLINI	<table border="1"> <thead> <tr> <th>Codice</th> <th>Descrizione</th> <th>Qtà</th> <th>UM</th> </tr> </thead> <tbody> <tr> <td>VM1224A0</td> <td>TUBOLARE TERMORETR 65MY 220MM 2 COLORI</td> <td>0.200</td> <td>M</td> </tr> <tr> <td>VM1820A0</td> <td>NOTTOLINO M6 CROMATO FISS. SUPPORTI</td> <td>10</td> <td>PZ</td> </tr> </tbody> </table>	Codice	Descrizione	Qtà	UM	VM1224A0	TUBOLARE TERMORETR 65MY 220MM 2 COLORI	0.200	M	VM1820A0	NOTTOLINO M6 CROMATO FISS. SUPPORTI	10	PZ												
Codice	Descrizione	Qtà	UM																										
VM1224A0	TUBOLARE TERMORETR 65MY 220MM 2 COLORI	0.200	M																										
VM1820A0	NOTTOLINO M6 CROMATO FISS. SUPPORTI	10	PZ																										
GRL1267A	SUPPORTO LAT. SX 6X600X400		KGRL1267A	KIT SUPPORTI LATERALI 6TG 600X400	<table border="1"> <thead> <tr> <th>Codice</th> <th>Descrizione</th> <th>Qtà</th> <th>UM</th> </tr> </thead> <tbody> <tr> <td>0H4215A0</td> <td>PROFILO GUIDA TEGLIE PAST.L372.5 B</td> <td>12</td> <td>PZ</td> </tr> <tr> <td>0H4420A0</td> <td>PIASTRINA SUPPORTO SONDA AL CUORE H35</td> <td>1</td> <td>PZ</td> </tr> <tr> <td>0H6585A1</td> <td>PROFILO PIANO PER SUPP 0H4380A 0H4381A</td> <td>2</td> <td>PZ</td> </tr> <tr> <td>0H6586A1</td> <td>PROFILO PIANO PER SUPP 0H4385A 0H4386A</td> <td>2</td> <td>PZ</td> </tr> <tr> <td>VM1059A1</td> <td>FILM TERMORETRA IBILE H800</td> <td>1.500</td> <td>M</td> </tr> </tbody> </table>	Codice	Descrizione	Qtà	UM	0H4215A0	PROFILO GUIDA TEGLIE PAST.L372.5 B	12	PZ	0H4420A0	PIASTRINA SUPPORTO SONDA AL CUORE H35	1	PZ	0H6585A1	PROFILO PIANO PER SUPP 0H4380A 0H4381A	2	PZ	0H6586A1	PROFILO PIANO PER SUPP 0H4385A 0H4386A	2	PZ	VM1059A1	FILM TERMORETRA IBILE H800	1.500	M
Codice	Descrizione	Qtà	UM																										
0H4215A0	PROFILO GUIDA TEGLIE PAST.L372.5 B	12	PZ																										
0H4420A0	PIASTRINA SUPPORTO SONDA AL CUORE H35	1	PZ																										
0H6585A1	PROFILO PIANO PER SUPP 0H4380A 0H4381A	2	PZ																										
0H6586A1	PROFILO PIANO PER SUPP 0H4385A 0H4386A	2	PZ																										
VM1059A1	FILM TERMORETRA IBILE H800	1.500	M																										
GRL1268A	SUPPORTO LAT. DX 6X600X400		KGRL1267A	KIT SUPPORTI LATERALI 6TG 600X400	<table border="1"> <thead> <tr> <th>Codice</th> <th>Descrizione</th> <th>Qtà</th> <th>UM</th> </tr> </thead> <tbody> <tr> <td>0H4215A0</td> <td>PROFILO GUIDA TEGLIE PAST.L372.5 B</td> <td>12</td> <td>PZ</td> </tr> <tr> <td>0H4420A0</td> <td>PIASTRINA SUPPORTO SONDA AL CUORE H35</td> <td>1</td> <td>PZ</td> </tr> <tr> <td>0H6585A1</td> <td>PROFILO PIANO PER SUPP 0H4380A 0H4381A</td> <td>2</td> <td>PZ</td> </tr> <tr> <td>0H6586A1</td> <td>PROFILO PIANO PER SUPP 0H4385A 0H4386A</td> <td>2</td> <td>PZ</td> </tr> <tr> <td>VM1059A1</td> <td>FILM TERMORETRA IBILE H800</td> <td>1.500</td> <td>M</td> </tr> </tbody> </table>	Codice	Descrizione	Qtà	UM	0H4215A0	PROFILO GUIDA TEGLIE PAST.L372.5 B	12	PZ	0H4420A0	PIASTRINA SUPPORTO SONDA AL CUORE H35	1	PZ	0H6585A1	PROFILO PIANO PER SUPP 0H4380A 0H4381A	2	PZ	0H6586A1	PROFILO PIANO PER SUPP 0H4385A 0H4386A	2	PZ	VM1059A1	FILM TERMORETRA IBILE H800	1.500	M
Codice	Descrizione	Qtà	UM																										
0H4215A0	PROFILO GUIDA TEGLIE PAST.L372.5 B	12	PZ																										
0H4420A0	PIASTRINA SUPPORTO SONDA AL CUORE H35	1	PZ																										
0H6585A1	PROFILO PIANO PER SUPP 0H4380A 0H4381A	2	PZ																										
0H6586A1	PROFILO PIANO PER SUPP 0H4385A 0H4386A	2	PZ																										
VM1059A1	FILM TERMORETRA IBILE H800	1.500	M																										

COMPONENTE			RICAMBIO																																																		
Codice	Descrizione	Immagine	Codice	Descrizione	Lista componenti																																																
0G1474A	CARTER PUNTATO XB69- XV59-		0G1474A0	CARTER PUNTATO XB69- XV59-																																																	
MT1012A	MOTORE SIMMETRICO 330W 230V ALBERO D12		KMT1012A	KIT MOTORE 330W 230V ALBERO D12	<table border="1"> <thead> <tr> <th>Codice</th> <th>Descrizione</th> <th>Qtà</th> <th>UM</th> </tr> </thead> <tbody> <tr> <td>0H4305A1</td> <td>DISCO TENUTA ALBERO MOTORE INOX STP</td> <td>1</td> <td>PZ</td> </tr> <tr> <td>GN1140A2</td> <td>GUARNIZIONE PORTAMOTO RE STAMPAT</td> <td>1</td> <td>PZ</td> </tr> <tr> <td>GN1140A3</td> <td>GUARNIZIONE PORTAMOTO RE STAMPAT</td> <td>1</td> <td>PZ</td> </tr> <tr> <td>MT1012A0</td> <td>MOTORE SIMMETRICO 330W 230V ALBERO D12</td> <td>1</td> <td>PZ</td> </tr> <tr> <td>VE1550A0</td> <td>MAGNETE NEODIMIO 5X3 MM</td> <td>1</td> <td>PZ</td> </tr> <tr> <td>VI1077A1</td> <td>VITE M6X12 TE INOX</td> <td>1</td> <td>PZ</td> </tr> <tr> <td>VI1521A0</td> <td>RONDELLA PIANA 6X12X1 INOX</td> <td>1</td> <td>PZ</td> </tr> <tr> <td>VI1966A0</td> <td>VITE M4X14 TSP+ ZN</td> <td>1</td> <td>PZ</td> </tr> <tr> <td>VM1635A0</td> <td>DISCO SUPPORTO MAGNETE</td> <td>1</td> <td>PZ</td> </tr> <tr> <td>VM1794A0</td> <td>FASCETTA 430X4.8 PA66 NERA</td> <td>4</td> <td>PZ</td> </tr> <tr> <td>VM2103A0</td> <td>PIASTRINA FERMAFASCE TTA</td> <td>4</td> <td>PZ</td> </tr> </tbody> </table>	Codice	Descrizione	Qtà	UM	0H4305A1	DISCO TENUTA ALBERO MOTORE INOX STP	1	PZ	GN1140A2	GUARNIZIONE PORTAMOTO RE STAMPAT	1	PZ	GN1140A3	GUARNIZIONE PORTAMOTO RE STAMPAT	1	PZ	MT1012A0	MOTORE SIMMETRICO 330W 230V ALBERO D12	1	PZ	VE1550A0	MAGNETE NEODIMIO 5X3 MM	1	PZ	VI1077A1	VITE M6X12 TE INOX	1	PZ	VI1521A0	RONDELLA PIANA 6X12X1 INOX	1	PZ	VI1966A0	VITE M4X14 TSP+ ZN	1	PZ	VM1635A0	DISCO SUPPORTO MAGNETE	1	PZ	VM1794A0	FASCETTA 430X4.8 PA66 NERA	4	PZ	VM2103A0	PIASTRINA FERMAFASCE TTA	4	PZ
Codice	Descrizione	Qtà	UM																																																		
0H4305A1	DISCO TENUTA ALBERO MOTORE INOX STP	1	PZ																																																		
GN1140A2	GUARNIZIONE PORTAMOTO RE STAMPAT	1	PZ																																																		
GN1140A3	GUARNIZIONE PORTAMOTO RE STAMPAT	1	PZ																																																		
MT1012A0	MOTORE SIMMETRICO 330W 230V ALBERO D12	1	PZ																																																		
VE1550A0	MAGNETE NEODIMIO 5X3 MM	1	PZ																																																		
VI1077A1	VITE M6X12 TE INOX	1	PZ																																																		
VI1521A0	RONDELLA PIANA 6X12X1 INOX	1	PZ																																																		
VI1966A0	VITE M4X14 TSP+ ZN	1	PZ																																																		
VM1635A0	DISCO SUPPORTO MAGNETE	1	PZ																																																		
VM1794A0	FASCETTA 430X4.8 PA66 NERA	4	PZ																																																		
VM2103A0	PIASTRINA FERMAFASCE TTA	4	PZ																																																		
GN1140A	GUARNIZIONE PORTAMOTORE STAMPATO		KG1140A	KIT 5 PZ. GUARNIZIONE PORTAMOTORE	<table border="1"> <thead> <tr> <th>Codice</th> <th>Descrizione</th> <th>Qtà</th> <th>UM</th> </tr> </thead> <tbody> <tr> <td>GN1140A2</td> <td>GUARNIZIONE PORTAMOTO RE STAMPAT</td> <td>5</td> <td>PZ</td> </tr> <tr> <td>GN1140A3</td> <td>GUARNIZIONE PORTAMOTO RE STAMPAT</td> <td>5</td> <td>PZ</td> </tr> <tr> <td>VM1224A0</td> <td>TUBOLARE TERMORETR 65MY 220MM 2 COLORI</td> <td>0.200</td> <td>M</td> </tr> </tbody> </table>	Codice	Descrizione	Qtà	UM	GN1140A2	GUARNIZIONE PORTAMOTO RE STAMPAT	5	PZ	GN1140A3	GUARNIZIONE PORTAMOTO RE STAMPAT	5	PZ	VM1224A0	TUBOLARE TERMORETR 65MY 220MM 2 COLORI	0.200	M																																
Codice	Descrizione	Qtà	UM																																																		
GN1140A2	GUARNIZIONE PORTAMOTO RE STAMPAT	5	PZ																																																		
GN1140A3	GUARNIZIONE PORTAMOTO RE STAMPAT	5	PZ																																																		
VM1224A0	TUBOLARE TERMORETR 65MY 220MM 2 COLORI	0.200	M																																																		

COMPONENTE			RICAMBIO																										
Codice	Descrizione	Immagine	Codice	Descrizione	Lista componenti																								
0H4305A	DISCO TENUTA ALBERO MOTORE INOX STP		K0H4305A	KIT DISCO TENUTA ALBERO MOTORE	<table border="1"> <thead> <tr> <th>Codice</th> <th>Descrizione</th> <th>Qtià</th> <th>UM</th> </tr> </thead> <tbody> <tr> <td>0H4305A1</td> <td>DISCO TENUTA ALBERO MOTORE INOX STP</td> <td>1</td> <td>PZ</td> </tr> <tr> <td>GN1140A2</td> <td>GUARNIZIONE PORTAMOTO RE STAMPAT</td> <td>1</td> <td>PZ</td> </tr> <tr> <td>GN1140A3</td> <td>GUARNIZIONE PORTAMOTO RE STAMPAT</td> <td>1</td> <td>PZ</td> </tr> <tr> <td>SL1045A0</td> <td>SILICONE ANTRACITE S57 80 ML</td> <td>1</td> <td>PZ</td> </tr> <tr> <td>VI1220A1</td> <td>VITE AUTOFILETTA NTE 4.2X11 TCS+ MARUTE</td> <td>3</td> <td>PZ</td> </tr> </tbody> </table>	Codice	Descrizione	Qtià	UM	0H4305A1	DISCO TENUTA ALBERO MOTORE INOX STP	1	PZ	GN1140A2	GUARNIZIONE PORTAMOTO RE STAMPAT	1	PZ	GN1140A3	GUARNIZIONE PORTAMOTO RE STAMPAT	1	PZ	SL1045A0	SILICONE ANTRACITE S57 80 ML	1	PZ	VI1220A1	VITE AUTOFILETTA NTE 4.2X11 TCS+ MARUTE	3	PZ
					Codice	Descrizione	Qtià	UM																					
					0H4305A1	DISCO TENUTA ALBERO MOTORE INOX STP	1	PZ																					
					GN1140A2	GUARNIZIONE PORTAMOTO RE STAMPAT	1	PZ																					
					GN1140A3	GUARNIZIONE PORTAMOTO RE STAMPAT	1	PZ																					
SL1045A0	SILICONE ANTRACITE S57 80 ML	1	PZ																										
VI1220A1	VITE AUTOFILETTA NTE 4.2X11 TCS+ MARUTE	3	PZ																										
VN1181A	VENTOLA D196 H81 39 PALE VITE M6		KVN1181A	KIT VENTOLA D196 H81 39 PALE VITE M	<table border="1"> <thead> <tr> <th>Codice</th> <th>Descrizione</th> <th>Qtià</th> <th>UM</th> </tr> </thead> <tbody> <tr> <td>VI1077A1</td> <td>VITE M6X12 TE INOX</td> <td>1</td> <td>PZ</td> </tr> <tr> <td>VI1521A0</td> <td>RONDELLA PIANA 6X12X1 INOX</td> <td>1</td> <td>PZ</td> </tr> <tr> <td>VN1181A0</td> <td>VENTOLA D196 H81 39 PALE VITE M6</td> <td>1</td> <td>PZ</td> </tr> <tr> <td>VN1181A0</td> <td>VENTOLA D196 H81 39 PALE VITE M6</td> <td>1</td> <td>PZ</td> </tr> </tbody> </table>	Codice	Descrizione	Qtià	UM	VI1077A1	VITE M6X12 TE INOX	1	PZ	VI1521A0	RONDELLA PIANA 6X12X1 INOX	1	PZ	VN1181A0	VENTOLA D196 H81 39 PALE VITE M6	1	PZ	VN1181A0	VENTOLA D196 H81 39 PALE VITE M6	1	PZ				
					Codice	Descrizione	Qtià	UM																					
					VI1077A1	VITE M6X12 TE INOX	1	PZ																					
					VI1521A0	RONDELLA PIANA 6X12X1 INOX	1	PZ																					
VN1181A0	VENTOLA D196 H81 39 PALE VITE M6	1	PZ																										
VN1181A0	VENTOLA D196 H81 39 PALE VITE M6	1	PZ																										
TB1515A	TUBO EST.UMIDITA' + RC1165A0		TB1515A1	TUBO EST.UMIDITA' + RC1165A0																									
0H6334A	STAFFA SOSTEGNO MUFFOLA BL CL		0H6334A0	STAFFA SOSTEGNO MUFFOLA BL CL																									

COMPONENTE			RICAMBIO																										
Codice	Descrizione	Immagine	Codice	Descrizione	Lista componenti																								
0G1476A	DISTANZIALE CARTER BL CL		0G1476A0	DISTANZIALE CARTER BL CL																									
RS1261A	RESISTENZA MOTORE BAKERLUX\CHEFLU		KRS1261A	KIT RESISTENZA FRENATA 122W	<table border="1"> <thead> <tr> <th>Codice</th> <th>Descrizione</th> <th>Qtà</th> <th>UM</th> </tr> </thead> <tbody> <tr> <td>GN1326A1</td> <td>GUARNIZIONE RESISTENZA 71X19 G6.25</td> <td>1</td> <td>PZ</td> </tr> <tr> <td>RS1261A0</td> <td>RESISTENZA MOTORE BAKERLUX\CH EFLUX</td> <td>1</td> <td>PZ</td> </tr> <tr> <td>SL1045A0</td> <td>SILICONE ANTRACITE S57 80 ML</td> <td>1</td> <td>PZ</td> </tr> <tr> <td>VI1220A1</td> <td>VITE AUTOFILETTA NTE 4.2X11 TCS+ MARUTE</td> <td>2</td> <td>PZ</td> </tr> <tr> <td>VM2147A0</td> <td>SPUGNA ESD ROSA LISCIA 410X343X15 M</td> <td>1</td> <td>PZ</td> </tr> </tbody> </table>	Codice	Descrizione	Qtà	UM	GN1326A1	GUARNIZIONE RESISTENZA 71X19 G6.25	1	PZ	RS1261A0	RESISTENZA MOTORE BAKERLUX\CH EFLUX	1	PZ	SL1045A0	SILICONE ANTRACITE S57 80 ML	1	PZ	VI1220A1	VITE AUTOFILETTA NTE 4.2X11 TCS+ MARUTE	2	PZ	VM2147A0	SPUGNA ESD ROSA LISCIA 410X343X15 M	1	PZ
Codice	Descrizione	Qtà	UM																										
GN1326A1	GUARNIZIONE RESISTENZA 71X19 G6.25	1	PZ																										
RS1261A0	RESISTENZA MOTORE BAKERLUX\CH EFLUX	1	PZ																										
SL1045A0	SILICONE ANTRACITE S57 80 ML	1	PZ																										
VI1220A1	VITE AUTOFILETTA NTE 4.2X11 TCS+ MARUTE	2	PZ																										
VM2147A0	SPUGNA ESD ROSA LISCIA 410X343X15 M	1	PZ																										

ASM2750A/0.D00 - Copertura esterna

FRONTE

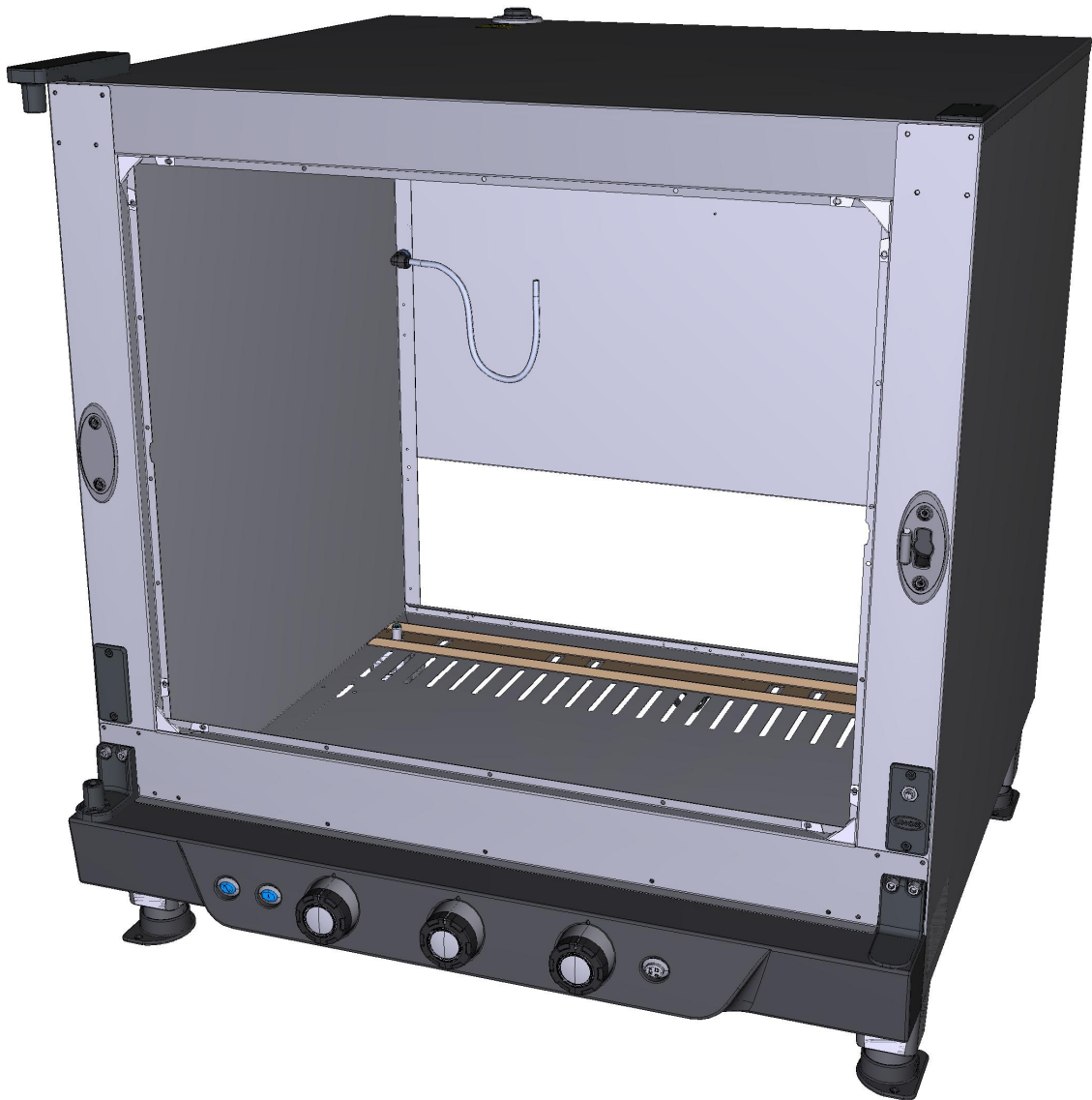

ASM2750A/0.D00 - Copertura esterna



RETRO



COMPONENTE			RICAMBIO																						
Codice	Descrizione	Immagine	Codice	Descrizione	Lista componenti																				
0H1450A	ANGOLO FACCIATA MUFFOLA INOX XB-XV-XG		0H1450A0	ANGOLO FACCIATA MUFFOLA INOX XB-XV-XG																					
VI1081A	VITE M6X25 TCEI INOX		KVI1081A	KIT 10 PZ VITE M6X25 TCEI INOX	<table border="1"> <thead> <tr> <th>Codice</th> <th>Descrizione</th> <th>Qtà</th> <th>UM</th> </tr> </thead> <tbody> <tr> <td>VI1081A0</td> <td>VITE M6X25 TCEI INOX</td> <td>10</td> <td>PZ</td> </tr> <tr> <td>VM1224A0</td> <td>TUBOLARE TERMORETR 65MY 220MM 2 COLORI</td> <td>0.200</td> <td>M</td> </tr> </tbody> </table>	Codice	Descrizione	Qtà	UM	VI1081A0	VITE M6X25 TCEI INOX	10	PZ	VM1224A0	TUBOLARE TERMORETR 65MY 220MM 2 COLORI	0.200	M								
Codice	Descrizione	Qtà	UM																						
VI1081A0	VITE M6X25 TCEI INOX	10	PZ																						
VM1224A0	TUBOLARE TERMORETR 65MY 220MM 2 COLORI	0.200	M																						
VL1026A	CURVA PER TUBO DI SCARICO		KVL1026A	KIT CURVA PER TUBO DI SCARICO	<table border="1"> <thead> <tr> <th>Codice</th> <th>Descrizione</th> <th>Qtà</th> <th>UM</th> </tr> </thead> <tbody> <tr> <td>GN1400A0</td> <td>GUARNIZIONE SIFONE</td> <td>1</td> <td>PZ</td> </tr> <tr> <td>VL1026A0</td> <td>CURVA PER TUBO DI SCARICO</td> <td>1</td> <td>PZ</td> </tr> <tr> <td>VM1224A0</td> <td>TUBOLARE TERMORETR 65MY 220MM 2 COLORI</td> <td>0.300</td> <td>M</td> </tr> <tr> <td>VM2039A0</td> <td>ANELLO FISSAGGIO CURVA DI SCARICO</td> <td>1</td> <td>PZ</td> </tr> </tbody> </table>	Codice	Descrizione	Qtà	UM	GN1400A0	GUARNIZIONE SIFONE	1	PZ	VL1026A0	CURVA PER TUBO DI SCARICO	1	PZ	VM1224A0	TUBOLARE TERMORETR 65MY 220MM 2 COLORI	0.300	M	VM2039A0	ANELLO FISSAGGIO CURVA DI SCARICO	1	PZ
Codice	Descrizione	Qtà	UM																						
GN1400A0	GUARNIZIONE SIFONE	1	PZ																						
VL1026A0	CURVA PER TUBO DI SCARICO	1	PZ																						
VM1224A0	TUBOLARE TERMORETR 65MY 220MM 2 COLORI	0.300	M																						
VM2039A0	ANELLO FISSAGGIO CURVA DI SCARICO	1	PZ																						
VM2039A	ANELLO FISSAGGIO CURVA DI SCARICO		KVL1026A	KIT CURVA PER TUBO DI SCARICO	<table border="1"> <thead> <tr> <th>Codice</th> <th>Descrizione</th> <th>Qtà</th> <th>UM</th> </tr> </thead> <tbody> <tr> <td>GN1400A0</td> <td>GUARNIZIONE SIFONE</td> <td>1</td> <td>PZ</td> </tr> <tr> <td>VL1026A0</td> <td>CURVA PER TUBO DI SCARICO</td> <td>1</td> <td>PZ</td> </tr> <tr> <td>VM1224A0</td> <td>TUBOLARE TERMORETR 65MY 220MM 2 COLORI</td> <td>0.300</td> <td>M</td> </tr> <tr> <td>VM2039A0</td> <td>ANELLO FISSAGGIO CURVA DI SCARICO</td> <td>1</td> <td>PZ</td> </tr> </tbody> </table>	Codice	Descrizione	Qtà	UM	GN1400A0	GUARNIZIONE SIFONE	1	PZ	VL1026A0	CURVA PER TUBO DI SCARICO	1	PZ	VM1224A0	TUBOLARE TERMORETR 65MY 220MM 2 COLORI	0.300	M	VM2039A0	ANELLO FISSAGGIO CURVA DI SCARICO	1	PZ
Codice	Descrizione	Qtà	UM																						
GN1400A0	GUARNIZIONE SIFONE	1	PZ																						
VL1026A0	CURVA PER TUBO DI SCARICO	1	PZ																						
VM1224A0	TUBOLARE TERMORETR 65MY 220MM 2 COLORI	0.300	M																						
VM2039A0	ANELLO FISSAGGIO CURVA DI SCARICO	1	PZ																						

COMPONENTE			RICAMBIO																														
Codice	Descrizione	Immagine	Codice	Descrizione	Lista componenti																												
VM2035A	SUPPORTO PER TUBO DI SCARICO		KVM2035A	KIT 2 PZ SUPPORTO PER TUBO DI SCARICO	<table border="1"> <thead> <tr> <th>Codice</th> <th>Descrizione</th> <th>Qtà</th> <th>UM</th> </tr> </thead> <tbody> <tr> <td>VM1224A0</td> <td>TUBOLARE TERMORETR 65MY 220MM 2 COLORI</td> <td>0.250</td> <td>M</td> </tr> <tr> <td>VM2035A0</td> <td>SUPPORTO PER TUBO DI SCARICO</td> <td>2</td> <td>PZ</td> </tr> </tbody> </table>	Codice	Descrizione	Qtà	UM	VM1224A0	TUBOLARE TERMORETR 65MY 220MM 2 COLORI	0.250	M	VM2035A0	SUPPORTO PER TUBO DI SCARICO	2	PZ																
Codice	Descrizione	Qtà	UM																														
VM1224A0	TUBOLARE TERMORETR 65MY 220MM 2 COLORI	0.250	M																														
VM2035A0	SUPPORTO PER TUBO DI SCARICO	2	PZ																														
VM1190A	SCROCCO MANIGLIA DX CT BT		KVM1190A	KIT SCROCCO MANIGLIA DX CT BT	<table border="1"> <thead> <tr> <th>Codice</th> <th>Descrizione</th> <th>Qtà</th> <th>UM</th> </tr> </thead> <tbody> <tr> <td>VI0239A1</td> <td>VITE AUTOFIL. 4.2X25 TCB+ INOX</td> <td>2</td> <td>PZ</td> </tr> <tr> <td>VI1220A1</td> <td>VITE AUTOFILETTA NTE 4.2X11 TCS+ MARUTE</td> <td>2</td> <td>PZ</td> </tr> <tr> <td>VM1190A2</td> <td>SCROCCO MANIGLIA DX CT BT</td> <td>1</td> <td>PZ</td> </tr> <tr> <td>VM1192A1</td> <td>COPERCHIO POST. SCROCCO MANIGLIA CT BT</td> <td>1</td> <td>PZ</td> </tr> <tr> <td>VM1224A0</td> <td>TUBOLARE TERMORETR 65MY 220MM 2 COLORI</td> <td>0.200</td> <td>M</td> </tr> <tr> <td>VM1460A0</td> <td>COPERCHIO DX SCROCCO PORTA XBC/XVC</td> <td>1</td> <td>PZ</td> </tr> </tbody> </table>	Codice	Descrizione	Qtà	UM	VI0239A1	VITE AUTOFIL. 4.2X25 TCB+ INOX	2	PZ	VI1220A1	VITE AUTOFILETTA NTE 4.2X11 TCS+ MARUTE	2	PZ	VM1190A2	SCROCCO MANIGLIA DX CT BT	1	PZ	VM1192A1	COPERCHIO POST. SCROCCO MANIGLIA CT BT	1	PZ	VM1224A0	TUBOLARE TERMORETR 65MY 220MM 2 COLORI	0.200	M	VM1460A0	COPERCHIO DX SCROCCO PORTA XBC/XVC	1	PZ
Codice	Descrizione	Qtà	UM																														
VI0239A1	VITE AUTOFIL. 4.2X25 TCB+ INOX	2	PZ																														
VI1220A1	VITE AUTOFILETTA NTE 4.2X11 TCS+ MARUTE	2	PZ																														
VM1190A2	SCROCCO MANIGLIA DX CT BT	1	PZ																														
VM1192A1	COPERCHIO POST. SCROCCO MANIGLIA CT BT	1	PZ																														
VM1224A0	TUBOLARE TERMORETR 65MY 220MM 2 COLORI	0.200	M																														
VM1460A0	COPERCHIO DX SCROCCO PORTA XBC/XVC	1	PZ																														
VM1240A	TAPPO NYLON SUPPORTO CONTROSTAFFA		KVM1240A	KIT TAPPO SUPPORTO CONTROSTAFFA 4P	<table border="1"> <thead> <tr> <th>Codice</th> <th>Descrizione</th> <th>Qtà</th> <th>UM</th> </tr> </thead> <tbody> <tr> <td>VM1224A0</td> <td>TUBOLARE TERMORETR 65MY 220MM 2 COLORI</td> <td>0.200</td> <td>M</td> </tr> <tr> <td>VM1240A0</td> <td>TAPPO NYLON SUPPORTO CONTROSTAFFA</td> <td>4</td> <td>PZ</td> </tr> </tbody> </table>	Codice	Descrizione	Qtà	UM	VM1224A0	TUBOLARE TERMORETR 65MY 220MM 2 COLORI	0.200	M	VM1240A0	TAPPO NYLON SUPPORTO CONTROSTAFFA	4	PZ																
Codice	Descrizione	Qtà	UM																														
VM1224A0	TUBOLARE TERMORETR 65MY 220MM 2 COLORI	0.200	M																														
VM1240A0	TAPPO NYLON SUPPORTO CONTROSTAFFA	4	PZ																														
VM1195A	PIASTRINA COPRIFORI XVC204/304/504/704		VM1195A0	PIASTRINA COPRIFORI XVC204/304/504/704																													

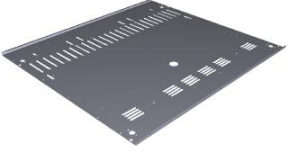
COMPONENTE			RICAMBIO																														
Codice	Descrizione	Immagine	Codice	Descrizione	Lista componenti																												
VM1192A	COPERCHIO POST. SCROCCO MANIGLIA CT BT		KVM1190A	KIT SCROCCO MANIGLIA DX CT BT	<table border="1"> <thead> <tr> <th>Codice</th> <th>Descrizione</th> <th>Qtà</th> <th>UM</th> </tr> </thead> <tbody> <tr> <td>VM1192A1</td> <td>COPERCHIO POST. SCROCCO MANIGLIA CT BT</td> <td>1</td> <td>PZ</td> </tr> <tr> <td>VM1224A0</td> <td>TUBOLARE TERMORETR 65MY 220MM 2 COLORI</td> <td>0.200</td> <td>M</td> </tr> <tr> <td>VM1460A0</td> <td>COPERCHIO DX SCROCCO PORTA XBC/XVC</td> <td>1</td> <td>PZ</td> </tr> </tbody> </table>	Codice	Descrizione	Qtà	UM	VM1192A1	COPERCHIO POST. SCROCCO MANIGLIA CT BT	1	PZ	VM1224A0	TUBOLARE TERMORETR 65MY 220MM 2 COLORI	0.200	M	VM1460A0	COPERCHIO DX SCROCCO PORTA XBC/XVC	1	PZ												
Codice	Descrizione	Qtà	UM																														
VM1192A1	COPERCHIO POST. SCROCCO MANIGLIA CT BT	1	PZ																														
VM1224A0	TUBOLARE TERMORETR 65MY 220MM 2 COLORI	0.200	M																														
VM1460A0	COPERCHIO DX SCROCCO PORTA XBC/XVC	1	PZ																														
VM1191A	SCROCCO MANIGLIA SX CT BT		KVM1191A	KIT SCROCCO MANIGLIA SX CT BT	<table border="1"> <thead> <tr> <th>Codice</th> <th>Descrizione</th> <th>Qtà</th> <th>UM</th> </tr> </thead> <tbody> <tr> <td>VI0239A1</td> <td>VITE AUTOFIL. 4.2X25 TCB+ INOX</td> <td>2</td> <td>PZ</td> </tr> <tr> <td>VI1220A1</td> <td>VITE AUTOFILETTA NTE 4.2X11 TCS+ MARUTE</td> <td>2</td> <td>PZ</td> </tr> <tr> <td>VM1191A2</td> <td>SCROCCO MANIGLIA SX CT BT</td> <td>1</td> <td>PZ</td> </tr> <tr> <td>VM1192A1</td> <td>COPERCHIO POST. SCROCCO MANIGLIA CT BT</td> <td>1</td> <td>PZ</td> </tr> <tr> <td>VM1224A0</td> <td>TUBOLARE TERMORETR 65MY 220MM 2 COLORI</td> <td>0.200</td> <td>M</td> </tr> <tr> <td>VM1460A0</td> <td>COPERCHIO DX SCROCCO PORTA XBC/XVC</td> <td>1</td> <td>PZ</td> </tr> </tbody> </table>	Codice	Descrizione	Qtà	UM	VI0239A1	VITE AUTOFIL. 4.2X25 TCB+ INOX	2	PZ	VI1220A1	VITE AUTOFILETTA NTE 4.2X11 TCS+ MARUTE	2	PZ	VM1191A2	SCROCCO MANIGLIA SX CT BT	1	PZ	VM1192A1	COPERCHIO POST. SCROCCO MANIGLIA CT BT	1	PZ	VM1224A0	TUBOLARE TERMORETR 65MY 220MM 2 COLORI	0.200	M	VM1460A0	COPERCHIO DX SCROCCO PORTA XBC/XVC	1	PZ
Codice	Descrizione	Qtà	UM																														
VI0239A1	VITE AUTOFIL. 4.2X25 TCB+ INOX	2	PZ																														
VI1220A1	VITE AUTOFILETTA NTE 4.2X11 TCS+ MARUTE	2	PZ																														
VM1191A2	SCROCCO MANIGLIA SX CT BT	1	PZ																														
VM1192A1	COPERCHIO POST. SCROCCO MANIGLIA CT BT	1	PZ																														
VM1224A0	TUBOLARE TERMORETR 65MY 220MM 2 COLORI	0.200	M																														
VM1460A0	COPERCHIO DX SCROCCO PORTA XBC/XVC	1	PZ																														
VM1165B	STAFFA SUPERIORE PORTA CT BT		KVM1165B	KIT STAFFA SUPERIORE PORTA CT BT CL BL	<table border="1"> <thead> <tr> <th>Codice</th> <th>Descrizione</th> <th>Qtà</th> <th>UM</th> </tr> </thead> <tbody> <tr> <td>VM1165B0</td> <td>STAFFA SUPERIORE PORTA CT BT</td> <td>1</td> <td>PZ</td> </tr> <tr> <td>VM1224A0</td> <td>TUBOLARE TERMORETR 65MY 220MM 2 COLORI</td> <td>0.250</td> <td>M</td> </tr> </tbody> </table>	Codice	Descrizione	Qtà	UM	VM1165B0	STAFFA SUPERIORE PORTA CT BT	1	PZ	VM1224A0	TUBOLARE TERMORETR 65MY 220MM 2 COLORI	0.250	M																
Codice	Descrizione	Qtà	UM																														
VM1165B0	STAFFA SUPERIORE PORTA CT BT	1	PZ																														
VM1224A0	TUBOLARE TERMORETR 65MY 220MM 2 COLORI	0.250	M																														

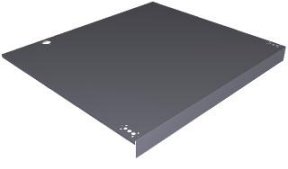

COMPONENTE			RICAMBIO														
Codice	Descrizione	Immagine	Codice	Descrizione	Lista componenti												
VM1166A	COPERCHIO STAFFA SUPERIORE PORTA		KVM1166A	KIT COPERCHIO STAFFA SUPERIORE PORTA	<table border="1"> <thead> <tr> <th>Codice</th> <th>Descrizione</th> <th>Qtà</th> <th>UM</th> </tr> </thead> <tbody> <tr> <td>VM1166A0</td> <td>COPERCHIO STAFFA SUPERIORE PORTA</td> <td>1</td> <td>PZ</td> </tr> <tr> <td>VM1224A0</td> <td>TUBOLARE TERMORETR 65MY 220MM 2 COLORI</td> <td>0.200</td> <td>M</td> </tr> </tbody> </table>	Codice	Descrizione	Qtà	UM	VM1166A0	COPERCHIO STAFFA SUPERIORE PORTA	1	PZ	VM1224A0	TUBOLARE TERMORETR 65MY 220MM 2 COLORI	0.200	M
Codice	Descrizione	Qtà	UM														
VM1166A0	COPERCHIO STAFFA SUPERIORE PORTA	1	PZ														
VM1224A0	TUBOLARE TERMORETR 65MY 220MM 2 COLORI	0.200	M														
0E1331B	FONDO ZINCATO BAKERLUX CHEFLU		0E1331B0	FONDO ZINCATO BAKERLUX CHEFLU													
0D2207A	FIANCO SX LUX		0D2207A0	FIANCO SX LUX													
0D2208A	FIANCO DX LUX		0D2208A0	FIANCO DX LUX													
0D2125A	COPERCHIO BAKERLUX CHEFLU		0D2125A0	COPERCHIO BAKERLUX CHEFLU													

COMPONENTE			RICAMBIO																						
Codice	Descrizione	Immagine	Codice	Descrizione	Lista componenti																				
0F1468A	SCHIENA ZINCATA XB69- XV59-		0F1468A0	SCHIENA ZINCATA XB69- XV59-																					
PD1066B	PIEDE H100 PLASTICA BICOMPONENTE		KPD1066B	KIT PIEDINO SERIE E H100	<table border="1"> <thead> <tr> <th>Codice</th> <th>Descrizione</th> <th>Qtà</th> <th>UM</th> </tr> </thead> <tbody> <tr> <td>PD1063A0</td> <td>STAFFA BLOCCAGGIO PIEDE CT BT</td> <td>1</td> <td>PZ</td> </tr> <tr> <td>PD1066B0</td> <td>PIEDE H100 PLASTICA BICOMPONENTE</td> <td>1</td> <td>PZ</td> </tr> <tr> <td>VI1220A1</td> <td>VITE AUTOFILETTA NTE 4.2X11 TCS+ MARUTE</td> <td>5</td> <td>PZ</td> </tr> <tr> <td>VM1224A0</td> <td>TUBOLARE TERMORETR 65MY 220MM 2 COLORI</td> <td>0.300</td> <td>M</td> </tr> </tbody> </table>	Codice	Descrizione	Qtà	UM	PD1063A0	STAFFA BLOCCAGGIO PIEDE CT BT	1	PZ	PD1066B0	PIEDE H100 PLASTICA BICOMPONENTE	1	PZ	VI1220A1	VITE AUTOFILETTA NTE 4.2X11 TCS+ MARUTE	5	PZ	VM1224A0	TUBOLARE TERMORETR 65MY 220MM 2 COLORI	0.300	M
Codice	Descrizione	Qtà	UM																						
PD1063A0	STAFFA BLOCCAGGIO PIEDE CT BT	1	PZ																						
PD1066B0	PIEDE H100 PLASTICA BICOMPONENTE	1	PZ																						
VI1220A1	VITE AUTOFILETTA NTE 4.2X11 TCS+ MARUTE	5	PZ																						
VM1224A0	TUBOLARE TERMORETR 65MY 220MM 2 COLORI	0.300	M																						
PD1063A	STAFFA BLOCCAGGIO PIEDE CT BT		KPD1063A	KIT STAFFA BLOCCAGGIO PIEDE	<table border="1"> <thead> <tr> <th>Codice</th> <th>Descrizione</th> <th>Qtà</th> <th>UM</th> </tr> </thead> <tbody> <tr> <td>PD1063A0</td> <td>STAFFA BLOCCAGGIO PIEDE CT BT</td> <td>4</td> <td>PZ</td> </tr> <tr> <td>VI1950A0</td> <td>VITE AUTOFORANT E 4,2X13 TCB INOX</td> <td>8</td> <td>PZ</td> </tr> <tr> <td>VM1224A0</td> <td>TUBOLARE TERMORETR 65MY 220MM 2 COLORI</td> <td>0.300</td> <td>M</td> </tr> </tbody> </table>	Codice	Descrizione	Qtà	UM	PD1063A0	STAFFA BLOCCAGGIO PIEDE CT BT	4	PZ	VI1950A0	VITE AUTOFORANT E 4,2X13 TCB INOX	8	PZ	VM1224A0	TUBOLARE TERMORETR 65MY 220MM 2 COLORI	0.300	M				
Codice	Descrizione	Qtà	UM																						
PD1063A0	STAFFA BLOCCAGGIO PIEDE CT BT	4	PZ																						
VI1950A0	VITE AUTOFORANT E 4,2X13 TCB INOX	8	PZ																						
VM1224A0	TUBOLARE TERMORETR 65MY 220MM 2 COLORI	0.300	M																						
0H2560A	CONTROSTAFFA ZINCATA PORTA C.T		0H2560A0	CONTROSTAFFA ZINCATA PORTA C.T																					

COMPONENTE			RICAMBIO																						
Codice	Descrizione	Immagine	Codice	Descrizione	Lista componenti																				
VM1460A	COPERCHIO DX SCROCCO PORTA XBC/XVC		KVM1460A	KIT COPERCHIO DX SCROCCO PORTA XBC/XVC	<table border="1"> <thead> <tr> <th>Codice</th> <th>Descrizione</th> <th>Qtà</th> <th>UM</th> </tr> </thead> <tbody> <tr> <td>VI0239A1</td> <td>VITE AUTOFIL. 4.2X25 TCB+ INOX</td> <td>2</td> <td>PZ</td> </tr> <tr> <td>VM1224A0</td> <td>TUBOLARE TERMORETR 65MY 220MM 2 COLORI</td> <td>0.200</td> <td>M</td> </tr> <tr> <td>VM1460A0</td> <td>COPERCHIO DX SCROCCO PORTA XBC/XVC</td> <td>1</td> <td>PZ</td> </tr> </tbody> </table>	Codice	Descrizione	Qtà	UM	VI0239A1	VITE AUTOFIL. 4.2X25 TCB+ INOX	2	PZ	VM1224A0	TUBOLARE TERMORETR 65MY 220MM 2 COLORI	0.200	M	VM1460A0	COPERCHIO DX SCROCCO PORTA XBC/XVC	1	PZ				
Codice	Descrizione	Qtà	UM																						
VI0239A1	VITE AUTOFIL. 4.2X25 TCB+ INOX	2	PZ																						
VM1224A0	TUBOLARE TERMORETR 65MY 220MM 2 COLORI	0.200	M																						
VM1460A0	COPERCHIO DX SCROCCO PORTA XBC/XVC	1	PZ																						
VM1461A	COPERCHIO SX SCROCCO PORTA XBC/XVC		VM1461A0	COPERCHIO SX SCROCCO PORTA XBC/XVC																					
VN1165A	VENTOLA RAFFREDDAMENTO 230VAC 50/60HZ 12		KVN1165A	KIT VENTOLA RAFFR. 230V S.5E ADV/MM	<table border="1"> <thead> <tr> <th>Codice</th> <th>Descrizione</th> <th>Qtà</th> <th>UM</th> </tr> </thead> <tbody> <tr> <td>VI1099A0</td> <td>VITE AUTOFORANT E 4.8X13 TCB+ ZN</td> <td>4</td> <td>PZ</td> </tr> <tr> <td>VM1555A2</td> <td>SUPPORTO VENTOLA RAFFREDDAM ENTO CT BT</td> <td>1</td> <td>PZ</td> </tr> <tr> <td>VN1165A0</td> <td>VENTOLA RAFFREDDAM ENTO 230VAC 50/60HZ 12</td> <td>1</td> <td>PZ</td> </tr> <tr> <td>VN1165A0</td> <td>VENTOLA RAFFREDDAM ENTO 230VAC 50/60HZ 12</td> <td>1</td> <td>PZ</td> </tr> </tbody> </table>	Codice	Descrizione	Qtà	UM	VI1099A0	VITE AUTOFORANT E 4.8X13 TCB+ ZN	4	PZ	VM1555A2	SUPPORTO VENTOLA RAFFREDDAM ENTO CT BT	1	PZ	VN1165A0	VENTOLA RAFFREDDAM ENTO 230VAC 50/60HZ 12	1	PZ	VN1165A0	VENTOLA RAFFREDDAM ENTO 230VAC 50/60HZ 12	1	PZ
Codice	Descrizione	Qtà	UM																						
VI1099A0	VITE AUTOFORANT E 4.8X13 TCB+ ZN	4	PZ																						
VM1555A2	SUPPORTO VENTOLA RAFFREDDAM ENTO CT BT	1	PZ																						
VN1165A0	VENTOLA RAFFREDDAM ENTO 230VAC 50/60HZ 12	1	PZ																						
VN1165A0	VENTOLA RAFFREDDAM ENTO 230VAC 50/60HZ 12	1	PZ																						
VM1556A	PROTEZIONE VENTOLA RAFFREDAMENTO CT BT		KVM1556A	KIT PROTEZIONE VENTOLA RAFFREDDAMENTO	<table border="1"> <thead> <tr> <th>Codice</th> <th>Descrizione</th> <th>Qtà</th> <th>UM</th> </tr> </thead> <tbody> <tr> <td>VM1556A0</td> <td>PROTEZIONE VENTOLA RAFFREDAME NTO CT BT</td> <td>1</td> <td>PZ</td> </tr> </tbody> </table>	Codice	Descrizione	Qtà	UM	VM1556A0	PROTEZIONE VENTOLA RAFFREDAME NTO CT BT	1	PZ												
Codice	Descrizione	Qtà	UM																						
VM1556A0	PROTEZIONE VENTOLA RAFFREDAME NTO CT BT	1	PZ																						

COMPONENTE			RICAMBIO																						
Codice	Descrizione	Immagine	Codice	Descrizione	Lista componenti																				
VM1555A	SUPPORTO VENTOLA RAFFREDDAMENTO CT BT		KVN1165A	KIT VENTOLA RAFFR. 230V S.5E ADV/MM	<table border="1"> <thead> <tr> <th>Codice</th> <th>Descrizione</th> <th>Qtà</th> <th>UM</th> </tr> </thead> <tbody> <tr> <td>VI1099A0</td> <td>VITE AUTOFORANT E 4.8X13 TCB+ ZN</td> <td>4</td> <td>PZ</td> </tr> <tr> <td>VM1555A2</td> <td>SUPPORTO VENTOLA RAFFREDDAM ENTO CT BT</td> <td>1</td> <td>PZ</td> </tr> <tr> <td>VN1165A0</td> <td>VENTOLA RAFFREDDAM ENTO 230VAC 50/60HZ 12</td> <td>1</td> <td>PZ</td> </tr> <tr> <td>VN1165A0</td> <td>VENTOLA RAFFREDDAM ENTO 230VAC 50/60HZ 12</td> <td>1</td> <td>PZ</td> </tr> </tbody> </table>	Codice	Descrizione	Qtà	UM	VI1099A0	VITE AUTOFORANT E 4.8X13 TCB+ ZN	4	PZ	VM1555A2	SUPPORTO VENTOLA RAFFREDDAM ENTO CT BT	1	PZ	VN1165A0	VENTOLA RAFFREDDAM ENTO 230VAC 50/60HZ 12	1	PZ	VN1165A0	VENTOLA RAFFREDDAM ENTO 230VAC 50/60HZ 12	1	PZ
			Codice	Descrizione	Qtà	UM																			
VI1099A0	VITE AUTOFORANT E 4.8X13 TCB+ ZN	4	PZ																						
VM1555A2	SUPPORTO VENTOLA RAFFREDDAM ENTO CT BT	1	PZ																						
VN1165A0	VENTOLA RAFFREDDAM ENTO 230VAC 50/60HZ 12	1	PZ																						
VN1165A0	VENTOLA RAFFREDDAM ENTO 230VAC 50/60HZ 12	1	PZ																						
KVN1164A	KIT VENTOLA RAFFREDDAMENTO 12VDC S.5/5E	<table border="1"> <thead> <tr> <th>Codice</th> <th>Descrizione</th> <th>Qtà</th> <th>UM</th> </tr> </thead> <tbody> <tr> <td>VI1099A0</td> <td>VITE AUTOFORANT E 4.8X13 TCB+ ZN</td> <td>4</td> <td>PZ</td> </tr> <tr> <td>VM1555A2</td> <td>SUPPORTO VENTOLA RAFFREDDAM ENTO CT BT</td> <td>1</td> <td>PZ</td> </tr> <tr> <td>VN1164A0</td> <td>VENTOLA RAFFREDDAM ENTO 12VDC</td> <td>1</td> <td>PZ</td> </tr> <tr> <td>VN1164A0</td> <td>VENTOLA RAFFREDDAM ENTO 12VDC</td> <td>1</td> <td>PZ</td> </tr> </tbody> </table>	Codice	Descrizione	Qtà	UM	VI1099A0	VITE AUTOFORANT E 4.8X13 TCB+ ZN	4	PZ	VM1555A2	SUPPORTO VENTOLA RAFFREDDAM ENTO CT BT	1	PZ	VN1164A0	VENTOLA RAFFREDDAM ENTO 12VDC	1	PZ	VN1164A0	VENTOLA RAFFREDDAM ENTO 12VDC	1	PZ			
Codice	Descrizione	Qtà	UM																						
VI1099A0	VITE AUTOFORANT E 4.8X13 TCB+ ZN	4	PZ																						
VM1555A2	SUPPORTO VENTOLA RAFFREDDAM ENTO CT BT	1	PZ																						
VN1164A0	VENTOLA RAFFREDDAM ENTO 12VDC	1	PZ																						
VN1164A0	VENTOLA RAFFREDDAM ENTO 12VDC	1	PZ																						
0H6240A	LAMIERA CRUSCOTTO BAKERLUX CHEFLU		0H6240A0	LAMIERA CRUSCOTTO BAKERLUX CHEFLU																					
VM1975A	STAFFA INFERIORE SOSTEGNO PORTA		KVM1975A	KIT STAFFA INFERIORE PORTA CL BL	<table border="1"> <thead> <tr> <th>Codice</th> <th>Descrizione</th> <th>Qtà</th> <th>UM</th> </tr> </thead> <tbody> <tr> <td>VM1224A0</td> <td>TUBOLARE TERMORETR 65MY 220MM 2 COLORI</td> <td>0.250</td> <td>M</td> </tr> <tr> <td>VM1975A0</td> <td>STAFFA INFERIORE SOSTEGNO PORTA</td> <td>1</td> <td>PZ</td> </tr> </tbody> </table>	Codice	Descrizione	Qtà	UM	VM1224A0	TUBOLARE TERMORETR 65MY 220MM 2 COLORI	0.250	M	VM1975A0	STAFFA INFERIORE SOSTEGNO PORTA	1	PZ								
					Codice	Descrizione	Qtà	UM																	
VM1224A0	TUBOLARE TERMORETR 65MY 220MM 2 COLORI	0.250	M																						
VM1975A0	STAFFA INFERIORE SOSTEGNO PORTA	1	PZ																						

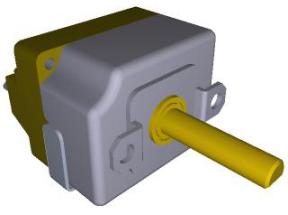
COMPONENTE			RICAMBIO																						
Codice	Descrizione	Immagine	Codice	Descrizione	Lista componenti																				
VM1974A	PIASTRINA CHIUSURA CRUSCOTTO		VM1974A0	PIASTRINA CHIUSURA CRUSCOTTO																					
VM1762A	SUPPORTO LAMPADA INTERNO		KVM1762A	KIT SUPPORTO INTERNO LAMPADA	<table border="1"> <thead> <tr> <th>Codice</th> <th>Descrizione</th> <th>Qtà</th> <th>UM</th> </tr> </thead> <tbody> <tr> <td>VM1224A0</td> <td>TUBOLARE TERMORETR 65MY 220MM 2 COLORI</td> <td>0.150</td> <td>M</td> </tr> <tr> <td>VM1762A0</td> <td>SUPPORTO LAMPADA INTERNO</td> <td>1</td> <td>PZ</td> </tr> </tbody> </table>	Codice	Descrizione	Qtà	UM	VM1224A0	TUBOLARE TERMORETR 65MY 220MM 2 COLORI	0.150	M	VM1762A0	SUPPORTO LAMPADA INTERNO	1	PZ								
Codice	Descrizione	Qtà	UM																						
VM1224A0	TUBOLARE TERMORETR 65MY 220MM 2 COLORI	0.150	M																						
VM1762A0	SUPPORTO LAMPADA INTERNO	1	PZ																						
VE1530A	GEMMA ELLITTICA AZZURRA TERMOMETRO ORO		KVE1530A	KIT GEMMA AZZURRA TERMOMETRO ORO	<table border="1"> <thead> <tr> <th>Codice</th> <th>Descrizione</th> <th>Qtà</th> <th>UM</th> </tr> </thead> <tbody> <tr> <td>VE1530A0</td> <td>GEMMA ELLITTICA AZZURRA TERMOMETR O ORO</td> <td>1</td> <td>PZ</td> </tr> <tr> <td>VM1224A0</td> <td>TUBOLARE TERMORETR 65MY 220MM 2 COLORI</td> <td>0.150</td> <td>M</td> </tr> <tr> <td>VM1762A0</td> <td>SUPPORTO LAMPADA INTERNO</td> <td>1</td> <td>PZ</td> </tr> <tr> <td>VM2009A0</td> <td>SUPPORTO ELLITTICO D16 ARGENTO</td> <td>1</td> <td>PZ</td> </tr> </tbody> </table>	Codice	Descrizione	Qtà	UM	VE1530A0	GEMMA ELLITTICA AZZURRA TERMOMETR O ORO	1	PZ	VM1224A0	TUBOLARE TERMORETR 65MY 220MM 2 COLORI	0.150	M	VM1762A0	SUPPORTO LAMPADA INTERNO	1	PZ	VM2009A0	SUPPORTO ELLITTICO D16 ARGENTO	1	PZ
Codice	Descrizione	Qtà	UM																						
VE1530A0	GEMMA ELLITTICA AZZURRA TERMOMETR O ORO	1	PZ																						
VM1224A0	TUBOLARE TERMORETR 65MY 220MM 2 COLORI	0.150	M																						
VM1762A0	SUPPORTO LAMPADA INTERNO	1	PZ																						
VM2009A0	SUPPORTO ELLITTICO D16 ARGENTO	1	PZ																						
TM1005A	TIMER MI2 60 MIN 250V 16A		KTM1005A	KIT TIMER 60 MIN	<table border="1"> <thead> <tr> <th>Codice</th> <th>Descrizione</th> <th>Qtà</th> <th>UM</th> </tr> </thead> <tbody> <tr> <td>TM1005A0</td> <td>TIMER MI2 60 MIN 250V 16A</td> <td>1</td> <td>PZ</td> </tr> <tr> <td>VI1850A0</td> <td>VITE M4X6 TCB+ NICHELATA</td> <td>2</td> <td>PZ</td> </tr> <tr> <td>VM1224A0</td> <td>TUBOLARE TERMORETR 65MY 220MM 2 COLORI</td> <td>0.250</td> <td>M</td> </tr> </tbody> </table>	Codice	Descrizione	Qtà	UM	TM1005A0	TIMER MI2 60 MIN 250V 16A	1	PZ	VI1850A0	VITE M4X6 TCB+ NICHELATA	2	PZ	VM1224A0	TUBOLARE TERMORETR 65MY 220MM 2 COLORI	0.250	M				
Codice	Descrizione	Qtà	UM																						
TM1005A0	TIMER MI2 60 MIN 250V 16A	1	PZ																						
VI1850A0	VITE M4X6 TCB+ NICHELATA	2	PZ																						
VM1224A0	TUBOLARE TERMORETR 65MY 220MM 2 COLORI	0.250	M																						

COMPONENTE			RICAMBIO																						
Codice	Descrizione	Immagine	Codice	Descrizione	Lista componenti																				
TR1100A	TERMOSTATO REG. 269°C 55.19052.80		KTR1100A	KIT TERMOSTATO REGOLAZ. 269°C	<table border="1"> <thead> <tr> <th>Codice</th> <th>Descrizione</th> <th>Qtà</th> <th>UM</th> </tr> </thead> <tbody> <tr> <td>TR1100A0</td> <td>TERMOSTATO REG. 269°C 55.19052.80</td> <td>1</td> <td>PZ</td> </tr> <tr> <td>VI1850A0</td> <td>VITE M4X6 TCB+ NICHELATA</td> <td>2</td> <td>PZ</td> </tr> </tbody> </table>	Codice	Descrizione	Qtà	UM	TR1100A0	TERMOSTATO REG. 269°C 55.19052.80	1	PZ	VI1850A0	VITE M4X6 TCB+ NICHELATA	2	PZ								
Codice	Descrizione	Qtà	UM																						
TR1100A0	TERMOSTATO REG. 269°C 55.19052.80	1	PZ																						
VI1850A0	VITE M4X6 TCB+ NICHELATA	2	PZ																						
TM1001C	BUZZER ELETTRONICO 15S 120V		KTM1001C	KIT BUZZER 15 SEC	<table border="1"> <thead> <tr> <th>Codice</th> <th>Descrizione</th> <th>Qtà</th> <th>UM</th> </tr> </thead> <tbody> <tr> <td>TM1001C2</td> <td>BUZZER ELETTRONICO 15S 120V</td> <td>1</td> <td>PZ</td> </tr> <tr> <td>VI1220A1</td> <td>VITE AUTOFILETTA NTE 4.2X11 TCS+ MARUTE</td> <td>3</td> <td>PZ</td> </tr> <tr> <td>VI1850A0</td> <td>VITE M4X6 TCB+ NICHELATA</td> <td>3</td> <td>PZ</td> </tr> <tr> <td>VM1745A0</td> <td>SUPPORTO PER SCHEDA</td> <td>3</td> <td>PZ</td> </tr> </tbody> </table>	Codice	Descrizione	Qtà	UM	TM1001C2	BUZZER ELETTRONICO 15S 120V	1	PZ	VI1220A1	VITE AUTOFILETTA NTE 4.2X11 TCS+ MARUTE	3	PZ	VI1850A0	VITE M4X6 TCB+ NICHELATA	3	PZ	VM1745A0	SUPPORTO PER SCHEDA	3	PZ
Codice	Descrizione	Qtà	UM																						
TM1001C2	BUZZER ELETTRONICO 15S 120V	1	PZ																						
VI1220A1	VITE AUTOFILETTA NTE 4.2X11 TCS+ MARUTE	3	PZ																						
VI1850A0	VITE M4X6 TCB+ NICHELATA	3	PZ																						
VM1745A0	SUPPORTO PER SCHEDA	3	PZ																						
VE1535A	LUCE SPIA LED BIANCO 230V		KVE1535A	KIT 1 PZ.LUCE SPIA LED	<table border="1"> <thead> <tr> <th>Codice</th> <th>Descrizione</th> <th>Qtà</th> <th>UM</th> </tr> </thead> <tbody> <tr> <td>VE1535A1</td> <td>LUCE SPIA LED BIANCO 230V</td> <td>1</td> <td>PZ</td> </tr> <tr> <td>VM1224A0</td> <td>TUBOLARE TERMORETR 65MY 220MM 2 COLORI</td> <td>0.200</td> <td>M</td> </tr> </tbody> </table>	Codice	Descrizione	Qtà	UM	VE1535A1	LUCE SPIA LED BIANCO 230V	1	PZ	VM1224A0	TUBOLARE TERMORETR 65MY 220MM 2 COLORI	0.200	M								
Codice	Descrizione	Qtà	UM																						
VE1535A1	LUCE SPIA LED BIANCO 230V	1	PZ																						
VM1224A0	TUBOLARE TERMORETR 65MY 220MM 2 COLORI	0.200	M																						
			KVE0105A	KIT RICAMBIO SPIA VERDE NUVOLETTA	<table border="1"> <thead> <tr> <th>Codice</th> <th>Descrizione</th> <th>Qtà</th> <th>UM</th> </tr> </thead> <tbody> <tr> <td>VE1535A1</td> <td>LUCE SPIA LED BIANCO 230V</td> <td>1</td> <td>PZ</td> </tr> <tr> <td>VM1761A0</td> <td>SUPPORTO ELLITTICO NERO</td> <td>1</td> <td>PZ</td> </tr> <tr> <td>VM1762A0</td> <td>SUPPORTO LAMPADA INTERNO</td> <td>1</td> <td>PZ</td> </tr> <tr> <td>VM1903A0</td> <td>GEMMA VERDE NUVOLETTA ORO</td> <td>1</td> <td>PZ</td> </tr> </tbody> </table>	Codice	Descrizione	Qtà	UM	VE1535A1	LUCE SPIA LED BIANCO 230V	1	PZ	VM1761A0	SUPPORTO ELLITTICO NERO	1	PZ	VM1762A0	SUPPORTO LAMPADA INTERNO	1	PZ	VM1903A0	GEMMA VERDE NUVOLETTA ORO	1	PZ
Codice	Descrizione	Qtà	UM																						
VE1535A1	LUCE SPIA LED BIANCO 230V	1	PZ																						
VM1761A0	SUPPORTO ELLITTICO NERO	1	PZ																						
VM1762A0	SUPPORTO LAMPADA INTERNO	1	PZ																						
VM1903A0	GEMMA VERDE NUVOLETTA ORO	1	PZ																						
			KVE0104A	KIT SPIA VERDE NEUTRA	<table border="1"> <thead> <tr> <th>Codice</th> <th>Descrizione</th> <th>Qtà</th> <th>UM</th> </tr> </thead> <tbody> <tr> <td>VE1535A1</td> <td>LUCE SPIA LED BIANCO 230V</td> <td>1</td> <td>PZ</td> </tr> </tbody> </table>	Codice	Descrizione	Qtà	UM	VE1535A1	LUCE SPIA LED BIANCO 230V	1	PZ												
Codice	Descrizione	Qtà	UM																						
VE1535A1	LUCE SPIA LED BIANCO 230V	1	PZ																						

COMPONENTE			RICAMBIO																						
Codice	Descrizione	Immagine	Codice	Descrizione	Lista componenti																				
VE1535A	LUCE SPIA LED BIANCO 230V		KVE0104A	KIT SPIA VERDE NEUTRA	<table border="1"> <thead> <tr> <th>Codice</th> <th>Descrizione</th> <th>Qtà</th> <th>UM</th> </tr> </thead> <tbody> <tr> <td>VM1224A0</td> <td>TUBOLARE TERMOMETR 65MY 220MM 2 COLORI</td> <td>0.200</td> <td>M</td> </tr> <tr> <td>VM1761A0</td> <td>SUPPORTO ELLITTICO NERO</td> <td>1</td> <td>PZ</td> </tr> <tr> <td>VM1762A0</td> <td>SUPPORTO LAMPADA INTERNO</td> <td>1</td> <td>PZ</td> </tr> <tr> <td>VM1902A0</td> <td>GEMMA VERDE NEUTR</td> <td>1</td> <td>PZ</td> </tr> </tbody> </table>	Codice	Descrizione	Qtà	UM	VM1224A0	TUBOLARE TERMOMETR 65MY 220MM 2 COLORI	0.200	M	VM1761A0	SUPPORTO ELLITTICO NERO	1	PZ	VM1762A0	SUPPORTO LAMPADA INTERNO	1	PZ	VM1902A0	GEMMA VERDE NEUTR	1	PZ
			Codice	Descrizione	Qtà	UM																			
			VM1224A0	TUBOLARE TERMOMETR 65MY 220MM 2 COLORI	0.200	M																			
			VM1761A0	SUPPORTO ELLITTICO NERO	1	PZ																			
			VM1762A0	SUPPORTO LAMPADA INTERNO	1	PZ																			
			VM1902A0	GEMMA VERDE NEUTR	1	PZ																			
			KVE0102A	KIT GEMMA FIAMMA	<table border="1"> <thead> <tr> <th>Codice</th> <th>Descrizione</th> <th>Qtà</th> <th>UM</th> </tr> </thead> <tbody> <tr> <td>VE1535A1</td> <td>LUCE SPIA LED BIANCO 230V</td> <td>1</td> <td>PZ</td> </tr> <tr> <td>VM1761A0</td> <td>SUPPORTO ELLITTICO NERO</td> <td>1</td> <td>PZ</td> </tr> <tr> <td>VM1762A0</td> <td>SUPPORTO LAMPADA INTERNO</td> <td>1</td> <td>PZ</td> </tr> <tr> <td>VM1767A0</td> <td>GEMMA VERDE FIAMMA ORO</td> <td>1</td> <td>PZ</td> </tr> </tbody> </table>	Codice	Descrizione	Qtà	UM	VE1535A1	LUCE SPIA LED BIANCO 230V	1	PZ	VM1761A0	SUPPORTO ELLITTICO NERO	1	PZ	VM1762A0	SUPPORTO LAMPADA INTERNO	1	PZ	VM1767A0	GEMMA VERDE FIAMMA ORO	1	PZ
			Codice	Descrizione	Qtà	UM																			
			VE1535A1	LUCE SPIA LED BIANCO 230V	1	PZ																			
			VM1761A0	SUPPORTO ELLITTICO NERO	1	PZ																			
			VM1762A0	SUPPORTO LAMPADA INTERNO	1	PZ																			
			VM1767A0	GEMMA VERDE FIAMMA ORO	1	PZ																			
KVE0101A	KIT GEMMA VERDE SINUSOIDE	<table border="1"> <thead> <tr> <th>Codice</th> <th>Descrizione</th> <th>Qtà</th> <th>UM</th> </tr> </thead> <tbody> <tr> <td>VE1535A1</td> <td>LUCE SPIA LED BIANCO 230V</td> <td>1</td> <td>PZ</td> </tr> <tr> <td>VM1761A0</td> <td>SUPPORTO ELLITTICO NERO</td> <td>1</td> <td>PZ</td> </tr> <tr> <td>VM1762A0</td> <td>SUPPORTO LAMPADA INTERNO</td> <td>1</td> <td>PZ</td> </tr> <tr> <td>VM1765A0</td> <td>GEMMA VERDE SINUSOIDE ORO</td> <td>1</td> <td>PZ</td> </tr> </tbody> </table>	Codice	Descrizione	Qtà	UM	VE1535A1	LUCE SPIA LED BIANCO 230V	1	PZ	VM1761A0	SUPPORTO ELLITTICO NERO	1	PZ	VM1762A0	SUPPORTO LAMPADA INTERNO	1	PZ	VM1765A0	GEMMA VERDE SINUSOIDE ORO	1	PZ			
Codice	Descrizione	Qtà	UM																						
VE1535A1	LUCE SPIA LED BIANCO 230V	1	PZ																						
VM1761A0	SUPPORTO ELLITTICO NERO	1	PZ																						
VM1762A0	SUPPORTO LAMPADA INTERNO	1	PZ																						
VM1765A0	GEMMA VERDE SINUSOIDE ORO	1	PZ																						
KVE0100A	KIT GEMMA TERMOMETRO	<table border="1"> <thead> <tr> <th>Codice</th> <th>Descrizione</th> <th>Qtà</th> <th>UM</th> </tr> </thead> <tbody> <tr> <td>VE1530A0</td> <td>GEMMA ELLITTICA AZZURRA TERMOMETR O ORO</td> <td>1</td> <td>PZ</td> </tr> <tr> <td>VE1535A1</td> <td>LUCE SPIA LED BIANCO 230V</td> <td>1</td> <td>PZ</td> </tr> </tbody> </table>	Codice	Descrizione	Qtà	UM	VE1530A0	GEMMA ELLITTICA AZZURRA TERMOMETR O ORO	1	PZ	VE1535A1	LUCE SPIA LED BIANCO 230V	1	PZ											
Codice	Descrizione	Qtà	UM																						
VE1530A0	GEMMA ELLITTICA AZZURRA TERMOMETR O ORO	1	PZ																						
VE1535A1	LUCE SPIA LED BIANCO 230V	1	PZ																						

COMPONENTE			RICAMBIO																																			
Codice	Descrizione	Immagine	Codice	Descrizione	Lista componenti																																	
VE1535A	LUCE SPIA LED BIANCO 230V		KVE0100A	KIT GEMMA TERMOMETRO	<table border="1"> <thead> <tr> <th>Codice</th> <th>Descrizione</th> <th>Qtà</th> <th>UM</th> </tr> </thead> <tbody> <tr> <td>VM1224A0</td> <td>TUBOLARE TERMOMETR 65MY 220MM 2 COLORI</td> <td>0.200</td> <td>M</td> </tr> <tr> <td>VM1761A0</td> <td>SUPPORTO ELLITTICO NERO</td> <td>1</td> <td>PZ</td> </tr> <tr> <td>VM1762A0</td> <td>SUPPORTO LAMPADA INTERNO</td> <td>1</td> <td>PZ</td> </tr> </tbody> </table>	Codice	Descrizione	Qtà	UM	VM1224A0	TUBOLARE TERMOMETR 65MY 220MM 2 COLORI	0.200	M	VM1761A0	SUPPORTO ELLITTICO NERO	1	PZ	VM1762A0	SUPPORTO LAMPADA INTERNO	1	PZ																	
			Codice	Descrizione	Qtà	UM																																
			VM1224A0	TUBOLARE TERMOMETR 65MY 220MM 2 COLORI	0.200	M																																
VM1761A0	SUPPORTO ELLITTICO NERO	1	PZ																																			
VM1762A0	SUPPORTO LAMPADA INTERNO	1	PZ																																			
KVE0011A	KIT MANOPOLE - GEMME SP	<table border="1"> <thead> <tr> <th>Codice</th> <th>Descrizione</th> <th>Qtà</th> <th>UM</th> </tr> </thead> <tbody> <tr> <td>MN1105A0</td> <td>MANOPOLA TERMOSTATO 120-400C XP</td> <td>1</td> <td>PZ</td> </tr> <tr> <td>MN1110A0</td> <td>GHIERA CON INDICE STAMPATO XP</td> <td>1</td> <td>PZ</td> </tr> <tr> <td>VE1530A0</td> <td>GEMMA ELLITTICA AZZURRA TERMOMETR O ORO</td> <td>1</td> <td>PZ</td> </tr> <tr> <td>VE1535A1</td> <td>LUCE SPIA LED BIANCO 230V</td> <td>1</td> <td>PZ</td> </tr> <tr> <td>VE1561A0</td> <td>INTERRUTTO RE BIPOLARE NA/NA</td> <td>1</td> <td>PZ</td> </tr> <tr> <td>VM1761A0</td> <td>SUPPORTO ELLITTICO NERO</td> <td>2</td> <td>PZ</td> </tr> <tr> <td>VM1762A0</td> <td>SUPPORTO LAMPADA INTERNO</td> <td>1</td> <td>PZ</td> </tr> <tr> <td>VM1776A0</td> <td>TASTO ARGENTO OPACO "0-1" ORO</td> <td>1</td> <td>PZ</td> </tr> </tbody> </table>	Codice	Descrizione	Qtà	UM	MN1105A0	MANOPOLA TERMOSTATO 120-400C XP	1	PZ	MN1110A0	GHIERA CON INDICE STAMPATO XP	1	PZ	VE1530A0	GEMMA ELLITTICA AZZURRA TERMOMETR O ORO	1	PZ	VE1535A1	LUCE SPIA LED BIANCO 230V	1	PZ	VE1561A0	INTERRUTTO RE BIPOLARE NA/NA	1	PZ	VM1761A0	SUPPORTO ELLITTICO NERO	2	PZ	VM1762A0	SUPPORTO LAMPADA INTERNO	1	PZ	VM1776A0	TASTO ARGENTO OPACO "0-1" ORO	1	PZ
Codice	Descrizione	Qtà	UM																																			
MN1105A0	MANOPOLA TERMOSTATO 120-400C XP	1	PZ																																			
MN1110A0	GHIERA CON INDICE STAMPATO XP	1	PZ																																			
VE1530A0	GEMMA ELLITTICA AZZURRA TERMOMETR O ORO	1	PZ																																			
VE1535A1	LUCE SPIA LED BIANCO 230V	1	PZ																																			
VE1561A0	INTERRUTTO RE BIPOLARE NA/NA	1	PZ																																			
VM1761A0	SUPPORTO ELLITTICO NERO	2	PZ																																			
VM1762A0	SUPPORTO LAMPADA INTERNO	1	PZ																																			
VM1776A0	TASTO ARGENTO OPACO "0-1" ORO	1	PZ																																			
KVE0008A	KIT GEMME AZZURRE XL	<table border="1"> <thead> <tr> <th>Codice</th> <th>Descrizione</th> <th>Qtà</th> <th>UM</th> </tr> </thead> <tbody> <tr> <td>VE1530A0</td> <td>GEMMA ELLITTICA AZZURRA TERMOMETR O ORO</td> <td>1</td> <td>PZ</td> </tr> <tr> <td>VE1535A1</td> <td>LUCE SPIA LED BIANCO 230V</td> <td>1</td> <td>PZ</td> </tr> <tr> <td>VE1561A0</td> <td>INTERRUTTO RE BIPOLARE NA/NA</td> <td>1</td> <td>PZ</td> </tr> <tr> <td>VE1562A0</td> <td>PULSANTE UNIPOLORE N</td> <td>1</td> <td>PZ</td> </tr> </tbody> </table>	Codice	Descrizione	Qtà	UM	VE1530A0	GEMMA ELLITTICA AZZURRA TERMOMETR O ORO	1	PZ	VE1535A1	LUCE SPIA LED BIANCO 230V	1	PZ	VE1561A0	INTERRUTTO RE BIPOLARE NA/NA	1	PZ	VE1562A0	PULSANTE UNIPOLORE N	1	PZ																
Codice	Descrizione	Qtà	UM																																			
VE1530A0	GEMMA ELLITTICA AZZURRA TERMOMETR O ORO	1	PZ																																			
VE1535A1	LUCE SPIA LED BIANCO 230V	1	PZ																																			
VE1561A0	INTERRUTTO RE BIPOLARE NA/NA	1	PZ																																			
VE1562A0	PULSANTE UNIPOLORE N	1	PZ																																			





COMPONENTE			RICAMBIO																																							
Codice	Descrizione	Immagine	Codice	Descrizione	Lista componenti																																					
VE1535A	LUCE SPIA LED BIANCO 230V		KVE0008A	KIT GEMME AZZURRE XL	<table border="1"> <thead> <tr> <th>Codice</th> <th>Descrizione</th> <th>Qtà</th> <th>UM</th> </tr> </thead> <tbody> <tr> <td>VM1224A0</td> <td>TUBOLARE TERMORETR 65MY 220MM 2 COLORI</td> <td>0.200</td> <td>M</td> </tr> <tr> <td>VM1761A0</td> <td>SUPPORTO ELLITTICO NERO</td> <td>3</td> <td>PZ</td> </tr> <tr> <td>VM1762A0</td> <td>SUPPORTO LAMPADA INTERNO</td> <td>1</td> <td>PZ</td> </tr> <tr> <td>VM1775A0</td> <td>TASTO ARGENTO OPACO NUVOLETTA ORO</td> <td>1</td> <td>PZ</td> </tr> <tr> <td>VM1776A0</td> <td>TASTO ARGENTO OPACO "0-1" ORO</td> <td>1</td> <td>PZ</td> </tr> </tbody> </table>	Codice	Descrizione	Qtà	UM	VM1224A0	TUBOLARE TERMORETR 65MY 220MM 2 COLORI	0.200	M	VM1761A0	SUPPORTO ELLITTICO NERO	3	PZ	VM1762A0	SUPPORTO LAMPADA INTERNO	1	PZ	VM1775A0	TASTO ARGENTO OPACO NUVOLETTA ORO	1	PZ	VM1776A0	TASTO ARGENTO OPACO "0-1" ORO	1	PZ													
			Codice	Descrizione	Qtà	UM																																				
VM1224A0	TUBOLARE TERMORETR 65MY 220MM 2 COLORI	0.200	M																																							
VM1761A0	SUPPORTO ELLITTICO NERO	3	PZ																																							
VM1762A0	SUPPORTO LAMPADA INTERNO	1	PZ																																							
VM1775A0	TASTO ARGENTO OPACO NUVOLETTA ORO	1	PZ																																							
VM1776A0	TASTO ARGENTO OPACO "0-1" ORO	1	PZ																																							
KVE0007A	KIT GEMME XF-XG	<table border="1"> <thead> <tr> <th>Codice</th> <th>Descrizione</th> <th>Qtà</th> <th>UM</th> </tr> </thead> <tbody> <tr> <td>VE1530A0</td> <td>GEMMA ELLITTICA AZZURRA TERMOMETR O ORO</td> <td>1</td> <td>PZ</td> </tr> <tr> <td>VE1535A1</td> <td>LUCE SPIA LED BIANCO 230V</td> <td>1</td> <td>PZ</td> </tr> <tr> <td>VE1562A0</td> <td>PULSANTE UNIPOLARE N</td> <td>1</td> <td>PZ</td> </tr> <tr> <td>VE1585A0</td> <td>GEMMA ELLITTICA AZZURRA SINUSOIDE ORO</td> <td>1</td> <td>PZ</td> </tr> <tr> <td>VM1224A0</td> <td>TUBOLARE TERMORETR 65MY 220MM 2 COLORI</td> <td>0.200</td> <td>M</td> </tr> <tr> <td>VM1761A0</td> <td>SUPPORTO ELLITTICO NERO</td> <td>5</td> <td>PZ</td> </tr> <tr> <td>VM1762A0</td> <td>SUPPORTO LAMPADA INTERNO</td> <td>4</td> <td>PZ</td> </tr> <tr> <td>VM1767A0</td> <td>GEMMA VERDE FIAMMA ORO</td> <td>1</td> <td>PZ</td> </tr> <tr> <td>VM1774A0</td> <td>TASTO ARGENTO OPACO FIAMMA ORO</td> <td>1</td> <td>PZ</td> </tr> </tbody> </table>	Codice	Descrizione	Qtà	UM	VE1530A0	GEMMA ELLITTICA AZZURRA TERMOMETR O ORO	1	PZ	VE1535A1	LUCE SPIA LED BIANCO 230V	1	PZ	VE1562A0	PULSANTE UNIPOLARE N	1	PZ	VE1585A0	GEMMA ELLITTICA AZZURRA SINUSOIDE ORO	1	PZ	VM1224A0	TUBOLARE TERMORETR 65MY 220MM 2 COLORI	0.200	M	VM1761A0	SUPPORTO ELLITTICO NERO	5	PZ	VM1762A0	SUPPORTO LAMPADA INTERNO	4	PZ	VM1767A0	GEMMA VERDE FIAMMA ORO	1	PZ	VM1774A0	TASTO ARGENTO OPACO FIAMMA ORO	1	PZ
Codice	Descrizione	Qtà	UM																																							
VE1530A0	GEMMA ELLITTICA AZZURRA TERMOMETR O ORO	1	PZ																																							
VE1535A1	LUCE SPIA LED BIANCO 230V	1	PZ																																							
VE1562A0	PULSANTE UNIPOLARE N	1	PZ																																							
VE1585A0	GEMMA ELLITTICA AZZURRA SINUSOIDE ORO	1	PZ																																							
VM1224A0	TUBOLARE TERMORETR 65MY 220MM 2 COLORI	0.200	M																																							
VM1761A0	SUPPORTO ELLITTICO NERO	5	PZ																																							
VM1762A0	SUPPORTO LAMPADA INTERNO	4	PZ																																							
VM1767A0	GEMMA VERDE FIAMMA ORO	1	PZ																																							
VM1774A0	TASTO ARGENTO OPACO FIAMMA ORO	1	PZ																																							

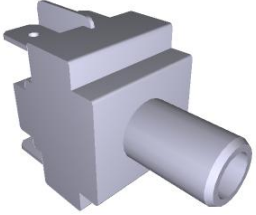



COMPONENTE			RICAMBIO																											
Codice	Descrizione	Immagine	Codice	Descrizione	Lista componenti																									
VE1535A	LUCE SPIA LED BIANCO 230V		KVE0007A	KIT GEMME XF-XG	<table border="1"> <thead> <tr> <th>Codice</th> <th>Descrizione</th> <th>Qtà</th> <th>UM</th> </tr> </thead> <tbody> <tr> <td>VM1775A0</td> <td>TASTO ARGENTO OPACO NUVOLETTA ORO</td> <td>1</td> <td>PZ</td> </tr> <tr> <td>VM1902A0</td> <td>GEMMA VERDE NEUTR</td> <td>1</td> <td>PZ</td> </tr> <tr> <td>VM1903A0</td> <td>GEMMA VERDE NUVOLETTA ORO</td> <td>1</td> <td>PZ</td> </tr> </tbody> </table>	Codice	Descrizione	Qtà	UM	VM1775A0	TASTO ARGENTO OPACO NUVOLETTA ORO	1	PZ	VM1902A0	GEMMA VERDE NEUTR	1	PZ	VM1903A0	GEMMA VERDE NUVOLETTA ORO	1	PZ									
			Codice	Descrizione	Qtà	UM																								
			VM1775A0	TASTO ARGENTO OPACO NUVOLETTA ORO	1	PZ																								
VM1902A0	GEMMA VERDE NEUTR	1	PZ																											
VM1903A0	GEMMA VERDE NUVOLETTA ORO	1	PZ																											
KLP1014A	KIT RICAMBIO SPIA AZZURRA SINUSOID	<table border="1"> <thead> <tr> <th>Codice</th> <th>Descrizione</th> <th>Qtà</th> <th>UM</th> </tr> </thead> <tbody> <tr> <td>VE1170A0</td> <td>SUPPORTO D16 ELLITTICO NICHEL OPAC</td> <td>2</td> <td>PZ</td> </tr> <tr> <td>VE1535A1</td> <td>LUCE SPIA LED BIANCO 230V</td> <td>2</td> <td>PZ</td> </tr> <tr> <td>VE1585A0</td> <td>GEMMA ELLITTICA AZZURRA SINUSOIDE ORO</td> <td>2</td> <td>PZ</td> </tr> <tr> <td>VM1224A0</td> <td>TUBOLARE TERMORETR 65MY 220MM 2 COLORI</td> <td>0.200</td> <td>M</td> </tr> <tr> <td>VM1762A0</td> <td>SUPPORTO LAMPADA INTERNO</td> <td>2</td> <td>PZ</td> </tr> <tr> <td>VM2009A0</td> <td>SUPPORTO ELLITTICO D16 ARGENTO</td> <td>1</td> <td>PZ</td> </tr> </tbody> </table>	Codice	Descrizione	Qtà	UM	VE1170A0	SUPPORTO D16 ELLITTICO NICHEL OPAC	2	PZ	VE1535A1	LUCE SPIA LED BIANCO 230V	2	PZ	VE1585A0	GEMMA ELLITTICA AZZURRA SINUSOIDE ORO	2	PZ	VM1224A0	TUBOLARE TERMORETR 65MY 220MM 2 COLORI	0.200	M	VM1762A0	SUPPORTO LAMPADA INTERNO	2	PZ	VM2009A0	SUPPORTO ELLITTICO D16 ARGENTO	1	PZ
Codice	Descrizione	Qtà	UM																											
VE1170A0	SUPPORTO D16 ELLITTICO NICHEL OPAC	2	PZ																											
VE1535A1	LUCE SPIA LED BIANCO 230V	2	PZ																											
VE1585A0	GEMMA ELLITTICA AZZURRA SINUSOIDE ORO	2	PZ																											
VM1224A0	TUBOLARE TERMORETR 65MY 220MM 2 COLORI	0.200	M																											
VM1762A0	SUPPORTO LAMPADA INTERNO	2	PZ																											
VM2009A0	SUPPORTO ELLITTICO D16 ARGENTO	1	PZ																											
KLP1012A	KIT SPIA AZZURRA TERMOSTATO	<table border="1"> <thead> <tr> <th>Codice</th> <th>Descrizione</th> <th>Qtà</th> <th>UM</th> </tr> </thead> <tbody> <tr> <td>VE1170A0</td> <td>SUPPORTO D16 ELLITTICO NICHEL OPAC</td> <td>1</td> <td>PZ</td> </tr> <tr> <td>VE1530A0</td> <td>GEMMA ELLITTICA AZZURRA TERMOMETR O ORO</td> <td>1</td> <td>PZ</td> </tr> <tr> <td>VE1535A1</td> <td>LUCE SPIA LED BIANCO 230V</td> <td>1</td> <td>PZ</td> </tr> <tr> <td>VM1224A0</td> <td>TUBOLARE TERMORETR 65MY 220MM 2 COLORI</td> <td>0.200</td> <td>M</td> </tr> <tr> <td>VM1762A0</td> <td>SUPPORTO LAMPADA INTERNO</td> <td>1</td> <td>PZ</td> </tr> </tbody> </table>	Codice	Descrizione	Qtà	UM	VE1170A0	SUPPORTO D16 ELLITTICO NICHEL OPAC	1	PZ	VE1530A0	GEMMA ELLITTICA AZZURRA TERMOMETR O ORO	1	PZ	VE1535A1	LUCE SPIA LED BIANCO 230V	1	PZ	VM1224A0	TUBOLARE TERMORETR 65MY 220MM 2 COLORI	0.200	M	VM1762A0	SUPPORTO LAMPADA INTERNO	1	PZ				
Codice	Descrizione	Qtà	UM																											
VE1170A0	SUPPORTO D16 ELLITTICO NICHEL OPAC	1	PZ																											
VE1530A0	GEMMA ELLITTICA AZZURRA TERMOMETR O ORO	1	PZ																											
VE1535A1	LUCE SPIA LED BIANCO 230V	1	PZ																											
VM1224A0	TUBOLARE TERMORETR 65MY 220MM 2 COLORI	0.200	M																											
VM1762A0	SUPPORTO LAMPADA INTERNO	1	PZ																											

COMPONENTE			RICAMBIO																														
Codice	Descrizione	Immagine	Codice	Descrizione	Lista componenti																												
VE1535A	LUCE SPIA LED BIANCO 230V		KLP1010A	KIT SPIA VERDE TERMOSTATO	<table border="1"> <thead> <tr> <th>Codice</th> <th>Descrizione</th> <th>Qtà</th> <th>UM</th> </tr> </thead> <tbody> <tr> <td>VE1170A0</td> <td>SUPPORTO D16 ELLITTICO NICHEL OPAC</td> <td>1</td> <td>PZ</td> </tr> <tr> <td>VE1535A1</td> <td>LUCE SPIA LED BIANCO 230V</td> <td>1</td> <td>PZ</td> </tr> <tr> <td>VM1762A0</td> <td>SUPPORTO LAMPADA INTERNO</td> <td>1</td> <td>PZ</td> </tr> <tr> <td>VM1764A0</td> <td>GEMMA VERDE TERMOMETR O ORO</td> <td>1</td> <td>PZ</td> </tr> </tbody> </table>	Codice	Descrizione	Qtà	UM	VE1170A0	SUPPORTO D16 ELLITTICO NICHEL OPAC	1	PZ	VE1535A1	LUCE SPIA LED BIANCO 230V	1	PZ	VM1762A0	SUPPORTO LAMPADA INTERNO	1	PZ	VM1764A0	GEMMA VERDE TERMOMETR O ORO	1	PZ								
Codice	Descrizione	Qtà	UM																														
VE1170A0	SUPPORTO D16 ELLITTICO NICHEL OPAC	1	PZ																														
VE1535A1	LUCE SPIA LED BIANCO 230V	1	PZ																														
VM1762A0	SUPPORTO LAMPADA INTERNO	1	PZ																														
VM1764A0	GEMMA VERDE TERMOMETR O ORO	1	PZ																														
VE1585A	GEMMA ELLITTICA AZZURRA SINUSOIDE ORO		KLP1014A	KIT RICAMBIO SPIA AZZURRA SINUSOID	<table border="1"> <thead> <tr> <th>Codice</th> <th>Descrizione</th> <th>Qtà</th> <th>UM</th> </tr> </thead> <tbody> <tr> <td>VE1170A0</td> <td>SUPPORTO D16 ELLITTICO NICHEL OPAC</td> <td>2</td> <td>PZ</td> </tr> <tr> <td>VE1535A1</td> <td>LUCE SPIA LED BIANCO 230V</td> <td>2</td> <td>PZ</td> </tr> <tr> <td>VE1585A0</td> <td>GEMMA ELLITTICA AZZURRA SINUSOIDE ORO</td> <td>2</td> <td>PZ</td> </tr> <tr> <td>VM1224A0</td> <td>TUBOLARE TERMORETR 65MY 220MM 2 COLORI</td> <td>0.200</td> <td>M</td> </tr> <tr> <td>VM1762A0</td> <td>SUPPORTO LAMPADA INTERNO</td> <td>2</td> <td>PZ</td> </tr> <tr> <td>VM2009A0</td> <td>SUPPORTO ELLITTICO D16 ARGENTO</td> <td>1</td> <td>PZ</td> </tr> </tbody> </table>	Codice	Descrizione	Qtà	UM	VE1170A0	SUPPORTO D16 ELLITTICO NICHEL OPAC	2	PZ	VE1535A1	LUCE SPIA LED BIANCO 230V	2	PZ	VE1585A0	GEMMA ELLITTICA AZZURRA SINUSOIDE ORO	2	PZ	VM1224A0	TUBOLARE TERMORETR 65MY 220MM 2 COLORI	0.200	M	VM1762A0	SUPPORTO LAMPADA INTERNO	2	PZ	VM2009A0	SUPPORTO ELLITTICO D16 ARGENTO	1	PZ
Codice	Descrizione	Qtà	UM																														
VE1170A0	SUPPORTO D16 ELLITTICO NICHEL OPAC	2	PZ																														
VE1535A1	LUCE SPIA LED BIANCO 230V	2	PZ																														
VE1585A0	GEMMA ELLITTICA AZZURRA SINUSOIDE ORO	2	PZ																														
VM1224A0	TUBOLARE TERMORETR 65MY 220MM 2 COLORI	0.200	M																														
VM1762A0	SUPPORTO LAMPADA INTERNO	2	PZ																														
VM2009A0	SUPPORTO ELLITTICO D16 ARGENTO	1	PZ																														
VM2009A	SUPPORTO ELLITTICO D16 ARGENTO		KVM2009A	KIT SUPPORTO ELLITTICO D16 ARGENTO	<table border="1"> <thead> <tr> <th>Codice</th> <th>Descrizione</th> <th>Qtà</th> <th>UM</th> </tr> </thead> <tbody> <tr> <td>VM1224A0</td> <td>TUBOLARE TERMORETR 65MY 220MM 2 COLORI</td> <td>0.150</td> <td>M</td> </tr> <tr> <td>VM2009A0</td> <td>SUPPORTO ELLITTICO D16 ARGENTO</td> <td>1</td> <td>PZ</td> </tr> </tbody> </table>	Codice	Descrizione	Qtà	UM	VM1224A0	TUBOLARE TERMORETR 65MY 220MM 2 COLORI	0.150	M	VM2009A0	SUPPORTO ELLITTICO D16 ARGENTO	1	PZ																
Codice	Descrizione	Qtà	UM																														
VM1224A0	TUBOLARE TERMORETR 65MY 220MM 2 COLORI	0.150	M																														
VM2009A0	SUPPORTO ELLITTICO D16 ARGENTO	1	PZ																														

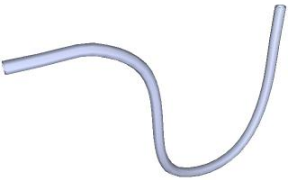
COMPONENTE			RICAMBIO																																														
Codice	Descrizione	Immagine	Codice	Descrizione	Lista componenti																																												
VE1561A	INTERRUTTORE BIPOLARE NA/NA		KVE0108A	KIT TASTO 0 - 1 ARGENTO OPACO	<table border="1"> <thead> <tr> <th>Codice</th> <th>Descrizione</th> <th>Qtà</th> <th>UM</th> </tr> </thead> <tbody> <tr> <td>VE1170A0</td> <td>SUPPORTO D16 ELLITTICO NICHEL OPAC</td> <td>1</td> <td>PZ</td> </tr> <tr> <td>VE1561A0</td> <td>INTERRUTTO RE BIPOLARE NA/NA</td> <td>1</td> <td>PZ</td> </tr> <tr> <td>VM1224A0</td> <td>TUBOLARE TERMORETR 65MY 220MM 2 COLORI</td> <td>0.200</td> <td>M</td> </tr> <tr> <td>VM1761A0</td> <td>SUPPORTO ELLITTICO NERO</td> <td>1</td> <td>PZ</td> </tr> <tr> <td>VM1776A0</td> <td>TASTO ARGENTO OPACO "0-1" ORO</td> <td>1</td> <td>PZ</td> </tr> </tbody> </table>	Codice	Descrizione	Qtà	UM	VE1170A0	SUPPORTO D16 ELLITTICO NICHEL OPAC	1	PZ	VE1561A0	INTERRUTTO RE BIPOLARE NA/NA	1	PZ	VM1224A0	TUBOLARE TERMORETR 65MY 220MM 2 COLORI	0.200	M	VM1761A0	SUPPORTO ELLITTICO NERO	1	PZ	VM1776A0	TASTO ARGENTO OPACO "0-1" ORO	1	PZ																				
Codice	Descrizione	Qtà	UM																																														
VE1170A0	SUPPORTO D16 ELLITTICO NICHEL OPAC	1	PZ																																														
VE1561A0	INTERRUTTO RE BIPOLARE NA/NA	1	PZ																																														
VM1224A0	TUBOLARE TERMORETR 65MY 220MM 2 COLORI	0.200	M																																														
VM1761A0	SUPPORTO ELLITTICO NERO	1	PZ																																														
VM1776A0	TASTO ARGENTO OPACO "0-1" ORO	1	PZ																																														
VM1972A	CRUSCOTTO BAKERLUX/CHEFLU X MECCANICO		KVM1972A	KIT CRUSCOTTO MANUALE LUX	<table border="1"> <thead> <tr> <th>Codice</th> <th>Descrizione</th> <th>Qtà</th> <th>UM</th> </tr> </thead> <tbody> <tr> <td>VE1530A0</td> <td>GEMMA ELLITTICA AZZURRA TERMOMETR O ORO</td> <td>1</td> <td>PZ</td> </tr> <tr> <td>VE1535A1</td> <td>LUCE SPIA LED BIANCO 230V</td> <td>2</td> <td>PZ</td> </tr> <tr> <td>VE1561A0</td> <td>INTERRUTTO RE BIPOLARE NA/NA</td> <td>1</td> <td>PZ</td> </tr> <tr> <td>VE1585A0</td> <td>GEMMA ELLITTICA AZZURRA SINUSOIDE ORO</td> <td>1</td> <td>PZ</td> </tr> <tr> <td>VM1782A0</td> <td>SUPPORTO LAMPADA INTERNO</td> <td>2</td> <td>PZ</td> </tr> <tr> <td>VM1794A0</td> <td>FASCETTA 430X4.8 PA66 NERA</td> <td>2</td> <td>PZ</td> </tr> <tr> <td>VM1972A0</td> <td>CRUSCOTTO BAKERLUX/CH EFLUX MECCANICO</td> <td>1</td> <td>PZ</td> </tr> <tr> <td>VM2007A0</td> <td>TASTO ARGENTO OPACO VELOCITA VENTOLA</td> <td>1</td> <td>PZ</td> </tr> <tr> <td>VM2009A0</td> <td>SUPPORTO ELLITTICO D16 ARGENTO</td> <td>3</td> <td>PZ</td> </tr> <tr> <td>VM2103A0</td> <td>PIASTRINA FERMAFASCE TTA</td> <td>2</td> <td>PZ</td> </tr> </tbody> </table>	Codice	Descrizione	Qtà	UM	VE1530A0	GEMMA ELLITTICA AZZURRA TERMOMETR O ORO	1	PZ	VE1535A1	LUCE SPIA LED BIANCO 230V	2	PZ	VE1561A0	INTERRUTTO RE BIPOLARE NA/NA	1	PZ	VE1585A0	GEMMA ELLITTICA AZZURRA SINUSOIDE ORO	1	PZ	VM1782A0	SUPPORTO LAMPADA INTERNO	2	PZ	VM1794A0	FASCETTA 430X4.8 PA66 NERA	2	PZ	VM1972A0	CRUSCOTTO BAKERLUX/CH EFLUX MECCANICO	1	PZ	VM2007A0	TASTO ARGENTO OPACO VELOCITA VENTOLA	1	PZ	VM2009A0	SUPPORTO ELLITTICO D16 ARGENTO	3	PZ	VM2103A0	PIASTRINA FERMAFASCE TTA	2	PZ
Codice	Descrizione	Qtà	UM																																														
VE1530A0	GEMMA ELLITTICA AZZURRA TERMOMETR O ORO	1	PZ																																														
VE1535A1	LUCE SPIA LED BIANCO 230V	2	PZ																																														
VE1561A0	INTERRUTTO RE BIPOLARE NA/NA	1	PZ																																														
VE1585A0	GEMMA ELLITTICA AZZURRA SINUSOIDE ORO	1	PZ																																														
VM1782A0	SUPPORTO LAMPADA INTERNO	2	PZ																																														
VM1794A0	FASCETTA 430X4.8 PA66 NERA	2	PZ																																														
VM1972A0	CRUSCOTTO BAKERLUX/CH EFLUX MECCANICO	1	PZ																																														
VM2007A0	TASTO ARGENTO OPACO VELOCITA VENTOLA	1	PZ																																														
VM2009A0	SUPPORTO ELLITTICO D16 ARGENTO	3	PZ																																														
VM2103A0	PIASTRINA FERMAFASCE TTA	2	PZ																																														

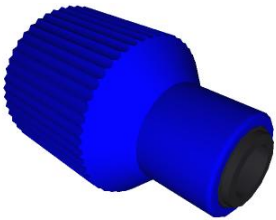
COMPONENTE			RICAMBIO														
Codice	Descrizione	Immagine	Codice	Descrizione	Lista componenti												
MN1112A	MANOPOLA TIMER CHEFLUX BAKERLU		KMN1112A	KIT MANOPOLA TIMER CL BL	<table border="1"> <thead> <tr> <th>Codice</th> <th>Descrizione</th> <th>Qtà</th> <th>UM</th> </tr> </thead> <tbody> <tr> <td>MN1112A1</td> <td>MANOPOLA TIMER CHEFLUX BAKERLUX</td> <td>1</td> <td>PZ</td> </tr> <tr> <td>VM1224A0</td> <td>TUBOLARE TERMORETR 65MY 220MM 2 COLORI</td> <td>0.200</td> <td>M</td> </tr> </tbody> </table>	Codice	Descrizione	Qtà	UM	MN1112A1	MANOPOLA TIMER CHEFLUX BAKERLUX	1	PZ	VM1224A0	TUBOLARE TERMORETR 65MY 220MM 2 COLORI	0.200	M
Codice	Descrizione	Qtà	UM														
MN1112A1	MANOPOLA TIMER CHEFLUX BAKERLUX	1	PZ														
VM1224A0	TUBOLARE TERMORETR 65MY 220MM 2 COLORI	0.200	M														
MN1111A	MANOPOLA LUX TERMOSTATO GRADI CELSIUS		KMN1111A	MANOPOLA TERMOSTATO LUX GRADI CELSIUS	<table border="1"> <thead> <tr> <th>Codice</th> <th>Descrizione</th> <th>Qtà</th> <th>UM</th> </tr> </thead> <tbody> <tr> <td>MN1111A1</td> <td>MANOPOLA LUX TERMOSTATO GRADI CELSIUS</td> <td>1</td> <td>PZ</td> </tr> <tr> <td>VM1224A0</td> <td>TUBOLARE TERMORETR 65MY 220MM 2 COLORI</td> <td>0.200</td> <td>M</td> </tr> </tbody> </table>	Codice	Descrizione	Qtà	UM	MN1111A1	MANOPOLA LUX TERMOSTATO GRADI CELSIUS	1	PZ	VM1224A0	TUBOLARE TERMORETR 65MY 220MM 2 COLORI	0.200	M
Codice	Descrizione	Qtà	UM														
MN1111A1	MANOPOLA LUX TERMOSTATO GRADI CELSIUS	1	PZ														
VM1224A0	TUBOLARE TERMORETR 65MY 220MM 2 COLORI	0.200	M														
MN1113A	MANOPOLA UMIDITA CHEFLUX BAKERLUX		KMN1113A	KIT MANOPOLA UMIDITA CL BL	<table border="1"> <thead> <tr> <th>Codice</th> <th>Descrizione</th> <th>Qtà</th> <th>UM</th> </tr> </thead> <tbody> <tr> <td>MN1113A2</td> <td>MANOPOLA UMIDITA CHEFLUX BAKERLUX</td> <td>1</td> <td>PZ</td> </tr> <tr> <td>VM1224A0</td> <td>TUBOLARE TERMORETR 65MY 220MM 2 COLORI</td> <td>0.200</td> <td>M</td> </tr> </tbody> </table>	Codice	Descrizione	Qtà	UM	MN1113A2	MANOPOLA UMIDITA CHEFLUX BAKERLUX	1	PZ	VM1224A0	TUBOLARE TERMORETR 65MY 220MM 2 COLORI	0.200	M
Codice	Descrizione	Qtà	UM														
MN1113A2	MANOPOLA UMIDITA CHEFLUX BAKERLUX	1	PZ														
VM1224A0	TUBOLARE TERMORETR 65MY 220MM 2 COLORI	0.200	M														
VE1295A	MICROINTERRUTTO RE PORTA MK 16A 230V UL		KVE1295A	KIT MICROINTERRUTTO RE PORTA 16A 230V	<table border="1"> <thead> <tr> <th>Codice</th> <th>Descrizione</th> <th>Qtà</th> <th>UM</th> </tr> </thead> <tbody> <tr> <td>VE1295A0</td> <td>MICROINTERR UTTORE PORTA MK 16A 230V UL</td> <td>1</td> <td>PZ</td> </tr> <tr> <td>VM1224A0</td> <td>TUBOLARE TERMORETR 65MY 220MM 2 COLORI</td> <td>0.300</td> <td>M</td> </tr> </tbody> </table>	Codice	Descrizione	Qtà	UM	VE1295A0	MICROINTERR UTTORE PORTA MK 16A 230V UL	1	PZ	VM1224A0	TUBOLARE TERMORETR 65MY 220MM 2 COLORI	0.300	M
Codice	Descrizione	Qtà	UM														
VE1295A0	MICROINTERR UTTORE PORTA MK 16A 230V UL	1	PZ														
VM1224A0	TUBOLARE TERMORETR 65MY 220MM 2 COLORI	0.300	M														
VM1200A	PIASTRINA SUPPORTO MICROPORTA MECCANICO		VM1200A0	PIASTRINA SUPPORTO MICROPORTA MECCANICO													

COMPONENTE			RICAMBIO														
Codice	Descrizione	Immagine	Codice	Descrizione	Lista componenti												
0H6333A	CONTROSTAFFA PORTA FILETTATA BL CL		0H6333A0	CONTROSTAFFA PORTA FILETTATA BL CL													
EL1195B	RACCORDO GOMITO Ø8F-Ø8M		KEL1195A	KIT 10 PZ RACCORDO GOMITO JG Ø8F-Ø8	<table border="1"> <thead> <tr> <th>Codice</th> <th>Descrizione</th> <th>Qtà</th> <th>UM</th> </tr> </thead> <tbody> <tr> <td>EL1195A0</td> <td>RACCORDO A GOMITO Ø8F-Ø8M</td> <td>10</td> <td>PZ</td> </tr> <tr> <td>VM1224A0</td> <td>TUBOLARE TERMORETR 65MY 220MM 2 COLORI</td> <td>0.200</td> <td>M</td> </tr> </tbody> </table>	Codice	Descrizione	Qtà	UM	EL1195A0	RACCORDO A GOMITO Ø8F-Ø8M	10	PZ	VM1224A0	TUBOLARE TERMORETR 65MY 220MM 2 COLORI	0.200	M
Codice	Descrizione	Qtà	UM														
EL1195A0	RACCORDO A GOMITO Ø8F-Ø8M	10	PZ														
VM1224A0	TUBOLARE TERMORETR 65MY 220MM 2 COLORI	0.200	M														
RC1002A	RACCORDO RIDUZIONE CODOLO 10M-8F		KRC1002A	KIT 10 PZ RIDUZIONE CODOLO JG Ø10M-Ø8F	<table border="1"> <thead> <tr> <th>Codice</th> <th>Descrizione</th> <th>Qtà</th> <th>UM</th> </tr> </thead> <tbody> <tr> <td>RC1002A0</td> <td>RACCORDO RIDUZIONE CODOLO 10M-8F</td> <td>10</td> <td>PZ</td> </tr> <tr> <td>VM1224A0</td> <td>TUBOLARE TERMORETR 65MY 220MM 2 COLORI</td> <td>0.200</td> <td>M</td> </tr> </tbody> </table>	Codice	Descrizione	Qtà	UM	RC1002A0	RACCORDO RIDUZIONE CODOLO 10M-8F	10	PZ	VM1224A0	TUBOLARE TERMORETR 65MY 220MM 2 COLORI	0.200	M
Codice	Descrizione	Qtà	UM														
RC1002A0	RACCORDO RIDUZIONE CODOLO 10M-8F	10	PZ														
VM1224A0	TUBOLARE TERMORETR 65MY 220MM 2 COLORI	0.200	M														
VM2028A	RONDELLA GOMMA 20X10X4		KVM2028A	KIT 5 PZ. RONDELLA GOMMA 20X10X4	<table border="1"> <thead> <tr> <th>Codice</th> <th>Descrizione</th> <th>Qtà</th> <th>UM</th> </tr> </thead> <tbody> <tr> <td>VM1224A0</td> <td>TUBOLARE TERMORETR 65MY 220MM 2 COLORI</td> <td>0.200</td> <td>M</td> </tr> <tr> <td>VM2028A0</td> <td>RONDELLA GOMMA 20X10X4</td> <td>5</td> <td>PZ</td> </tr> </tbody> </table>	Codice	Descrizione	Qtà	UM	VM1224A0	TUBOLARE TERMORETR 65MY 220MM 2 COLORI	0.200	M	VM2028A0	RONDELLA GOMMA 20X10X4	5	PZ
Codice	Descrizione	Qtà	UM														
VM1224A0	TUBOLARE TERMORETR 65MY 220MM 2 COLORI	0.200	M														
VM2028A0	RONDELLA GOMMA 20X10X4	5	PZ														
TB2808A	TB1815A0-D8 ACQUA ELETTROV. LUX 0,5M		TB2808A0	TB1815A0-D8 ACQUA ELETTROV. LUX 0,5M													

COMPONENTE			RICAMBIO																						
Codice	Descrizione	Immagine	Codice	Descrizione	Lista componenti																				
RC1365A	RACCORDO JG FEMMINA 3/4"-10		KRC1365A	KIT ATTACCO ACQUA DI RETE 3/4"-10 O 8 JG	<table border="1"> <thead> <tr> <th>Codice</th> <th>Descrizione</th> <th>Qtà</th> <th>UM</th> </tr> </thead> <tbody> <tr> <td>GN1200A1</td> <td>GUARNIZIONE D24 RACCORDO 3/4 SILICONE</td> <td>1</td> <td>PZ</td> </tr> <tr> <td>RC1002A0</td> <td>RACCORDO RIDUZIONE CODOLO 10M-8F</td> <td>1</td> <td>PZ</td> </tr> <tr> <td>RC1365A0</td> <td>RACCORDO JG FEMMINA 3/4"-10</td> <td>1</td> <td>PZ</td> </tr> <tr> <td>VM1224A0</td> <td>TUBOLARE TERMORETR 65MY 220MM 2 COLORI</td> <td>0.150</td> <td>M</td> </tr> </tbody> </table>	Codice	Descrizione	Qtà	UM	GN1200A1	GUARNIZIONE D24 RACCORDO 3/4 SILICONE	1	PZ	RC1002A0	RACCORDO RIDUZIONE CODOLO 10M-8F	1	PZ	RC1365A0	RACCORDO JG FEMMINA 3/4"-10	1	PZ	VM1224A0	TUBOLARE TERMORETR 65MY 220MM 2 COLORI	0.150	M
Codice	Descrizione	Qtà	UM																						
GN1200A1	GUARNIZIONE D24 RACCORDO 3/4 SILICONE	1	PZ																						
RC1002A0	RACCORDO RIDUZIONE CODOLO 10M-8F	1	PZ																						
RC1365A0	RACCORDO JG FEMMINA 3/4"-10	1	PZ																						
VM1224A0	TUBOLARE TERMORETR 65MY 220MM 2 COLORI	0.150	M																						
VL1034B	FILTRO ACQUA D10 MESH100		KVL1034C	KIT RICAMBIO FILTRO ACQUA MESH100 Ø8-Ø10	<table border="1"> <thead> <tr> <th>Codice</th> <th>Descrizione</th> <th>Qtà</th> <th>UM</th> </tr> </thead> <tbody> <tr> <td>RC1002A0</td> <td>RACCORDO RIDUZIONE CODOLO 10M-8F</td> <td>2</td> <td>PZ</td> </tr> <tr> <td>VL1034C0</td> <td>FILTRO ACQUA D10 MESH100</td> <td>1</td> <td>PZ</td> </tr> <tr> <td>VL1062C0</td> <td>FORCELLA BLOCCA FILTRO-RIDUTTORE PRES.</td> <td>1</td> <td>PZ</td> </tr> <tr> <td>VM1224A0</td> <td>TUBOLARE TERMORETR 65MY 220MM 2 COLORI</td> <td>0.300</td> <td>M</td> </tr> </tbody> </table>	Codice	Descrizione	Qtà	UM	RC1002A0	RACCORDO RIDUZIONE CODOLO 10M-8F	2	PZ	VL1034C0	FILTRO ACQUA D10 MESH100	1	PZ	VL1062C0	FORCELLA BLOCCA FILTRO-RIDUTTORE PRES.	1	PZ	VM1224A0	TUBOLARE TERMORETR 65MY 220MM 2 COLORI	0.300	M
Codice	Descrizione	Qtà	UM																						
RC1002A0	RACCORDO RIDUZIONE CODOLO 10M-8F	2	PZ																						
VL1034C0	FILTRO ACQUA D10 MESH100	1	PZ																						
VL1062C0	FORCELLA BLOCCA FILTRO-RIDUTTORE PRES.	1	PZ																						
VM1224A0	TUBOLARE TERMORETR 65MY 220MM 2 COLORI	0.300	M																						
TB2237A	TB2243A - Ø10 ALLACCIAMENTO RETE 1,5M		KTB2599A KTB2598A	KIT TUBO PET Ø10 L=100M TB2243A KIT TUBO PET Ø10 L=3M TB2243A0	<table border="1"> <thead> <tr> <th>Codice</th> <th>Descrizione</th> <th>Qtà</th> <th>UM</th> </tr> </thead> <tbody> <tr> <td>TB2243A0</td> <td>TUBO D10 PE TRASPARENT</td> <td>100</td> <td>M</td> </tr> <tr> <td>VM1059A1</td> <td>FILM TERMORETRA IBILE H800</td> <td>1.500</td> <td>M</td> </tr> <tr> <td>TB2243A0</td> <td>TUBO D10 PE TRASPARENT</td> <td>3</td> <td>M</td> </tr> </tbody> </table>	Codice	Descrizione	Qtà	UM	TB2243A0	TUBO D10 PE TRASPARENT	100	M	VM1059A1	FILM TERMORETRA IBILE H800	1.500	M	TB2243A0	TUBO D10 PE TRASPARENT	3	M				
Codice	Descrizione	Qtà	UM																						
TB2243A0	TUBO D10 PE TRASPARENT	100	M																						
VM1059A1	FILM TERMORETRA IBILE H800	1.500	M																						
TB2243A0	TUBO D10 PE TRASPARENT	3	M																						
RC1360A	RACCORDO GOMITO JG 10-10		KRC1360A	KIT 10 PZ RACCORDO GOMITO JG Ø10-Ø1	<table border="1"> <thead> <tr> <th>Codice</th> <th>Descrizione</th> <th>Qtà</th> <th>UM</th> </tr> </thead> <tbody> <tr> <td>RC1360A0</td> <td>RACCORDO GOMITO JG 10-10</td> <td>10</td> <td>PZ</td> </tr> <tr> <td>VM1224A0</td> <td>TUBOLARE TERMORETR 65MY 220MM 2 COLORI</td> <td>0.250</td> <td>M</td> </tr> </tbody> </table>	Codice	Descrizione	Qtà	UM	RC1360A0	RACCORDO GOMITO JG 10-10	10	PZ	VM1224A0	TUBOLARE TERMORETR 65MY 220MM 2 COLORI	0.250	M								
Codice	Descrizione	Qtà	UM																						
RC1360A0	RACCORDO GOMITO JG 10-10	10	PZ																						
VM1224A0	TUBOLARE TERMORETR 65MY 220MM 2 COLORI	0.250	M																						



COMPONENTE			RICAMBIO														
Codice	Descrizione	Immagine	Codice	Descrizione	Lista componenti												
EL1349A	CLIP BLOCCA PINZETTA RACCORDI D10		KEL1349A	KIT 10 PZ BLOCCA PINZETTA RACCORDI Ø10	<table border="1"><thead><tr><th>Codice</th><th>Descrizione</th><th>Qtà</th><th>UM</th></tr></thead><tbody><tr><td>EL1349A0</td><td>CLIP BLOCCA PINZETTA RACCORDI D1</td><td>10</td><td>PZ</td></tr><tr><td>VM1224A0</td><td>TUBOLARE TERMORETR 65MY 220MM 2 COLORI</td><td>0.200</td><td>M</td></tr></tbody></table>	Codice	Descrizione	Qtà	UM	EL1349A0	CLIP BLOCCA PINZETTA RACCORDI D1	10	PZ	VM1224A0	TUBOLARE TERMORETR 65MY 220MM 2 COLORI	0.200	M
Codice	Descrizione	Qtà	UM														
EL1349A0	CLIP BLOCCA PINZETTA RACCORDI D1	10	PZ														
VM1224A0	TUBOLARE TERMORETR 65MY 220MM 2 COLORI	0.200	M														

ASM4098A/0.D00 - Impianto elettrico

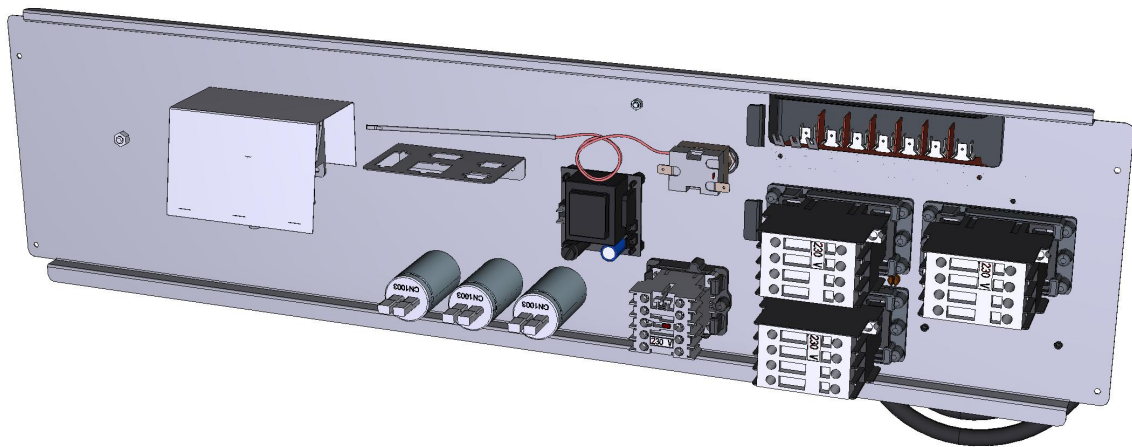

FRONTE





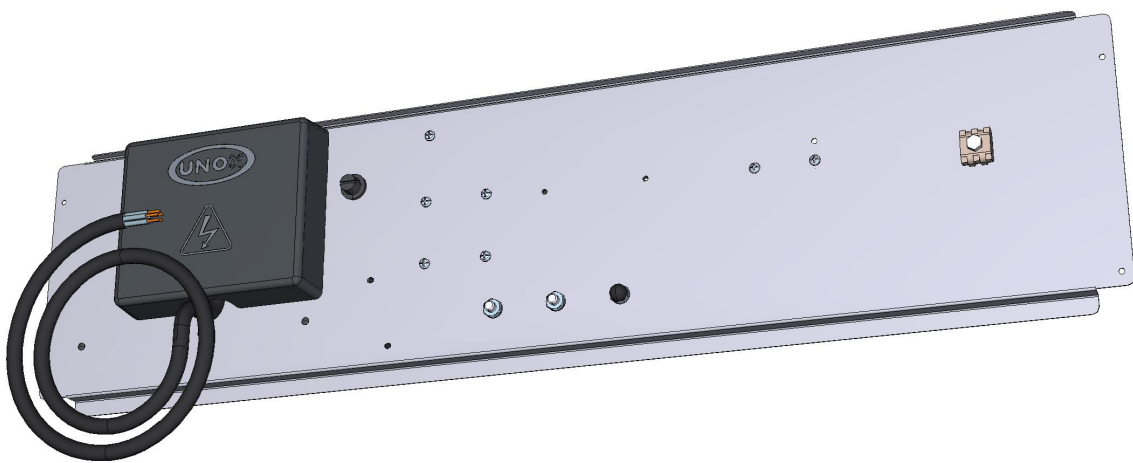

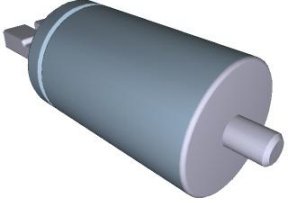

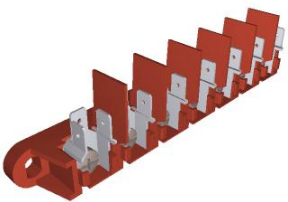
ASM4098A/0.D00 - Impianto elettrico

RETRO

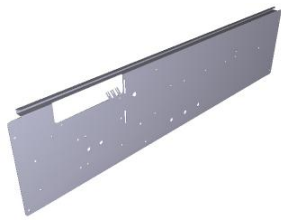
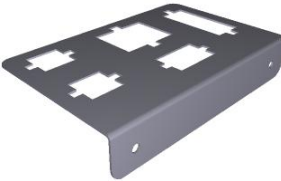

COMPONENTE			RICAMBIO																										
Codice	Descrizione	Immagine	Codice	Descrizione	Lista componenti																								
TR1136A	TERMOSTATO SIC. UNIP. 330°C		KTR1136A	KIT TERMOSTATO SICUREZZA 330°C	<table border="1"> <thead> <tr> <th>Codice</th> <th>Descrizione</th> <th>Qtà</th> <th>UM</th> </tr> </thead> <tbody> <tr> <td>0H7030A0</td> <td>COPERCHIO INGRESSO BULBO</td> <td>1</td> <td>PZ</td> </tr> <tr> <td>GN1531A0</td> <td>GUARNIZIONE TENUTA INGRESSO BULBO</td> <td>1</td> <td>PZ</td> </tr> <tr> <td>SL1045A0</td> <td>SILICONE ANTRACITE S57 80 ML</td> <td>1</td> <td>PZ</td> </tr> <tr> <td>TR1136A0</td> <td>TERMOSTATO SIC. UNIP. 330°C</td> <td>1</td> <td>PZ</td> </tr> <tr> <td>VI1220A1</td> <td>VITE AUTOFILETTA NTE 4.2X11 TCS+ MARUTE</td> <td>3</td> <td>PZ</td> </tr> </tbody> </table>	Codice	Descrizione	Qtà	UM	0H7030A0	COPERCHIO INGRESSO BULBO	1	PZ	GN1531A0	GUARNIZIONE TENUTA INGRESSO BULBO	1	PZ	SL1045A0	SILICONE ANTRACITE S57 80 ML	1	PZ	TR1136A0	TERMOSTATO SIC. UNIP. 330°C	1	PZ	VI1220A1	VITE AUTOFILETTA NTE 4.2X11 TCS+ MARUTE	3	PZ
Codice	Descrizione	Qtà	UM																										
0H7030A0	COPERCHIO INGRESSO BULBO	1	PZ																										
GN1531A0	GUARNIZIONE TENUTA INGRESSO BULBO	1	PZ																										
SL1045A0	SILICONE ANTRACITE S57 80 ML	1	PZ																										
TR1136A0	TERMOSTATO SIC. UNIP. 330°C	1	PZ																										
VI1220A1	VITE AUTOFILETTA NTE 4.2X11 TCS+ MARUTE	3	PZ																										
CN1003A	CONDENSATORE CORAZZATO 6,3 UF		KCN1003A	KIT CONDENSATORE MOTORE 6,3 UF	<table border="1"> <thead> <tr> <th>Codice</th> <th>Descrizione</th> <th>Qtà</th> <th>UM</th> </tr> </thead> <tbody> <tr> <td>CN1003A0</td> <td>CONDENSATO RE CORAZZATO 6,3 UF</td> <td>1</td> <td>PZ</td> </tr> <tr> <td>VI1931A0</td> <td>DADO M8X1.65 H4 CH13 ZINCATO</td> <td>1</td> <td>PZ</td> </tr> <tr> <td>VI1932A0</td> <td>RONDELLA DENTELLATA D8 ZINCATA</td> <td>1</td> <td>PZ</td> </tr> <tr> <td>VM1224A0</td> <td>TUBOLARE TERMORETR 65MY 220MM 2 COLORI</td> <td>0.200</td> <td>M</td> </tr> </tbody> </table>	Codice	Descrizione	Qtà	UM	CN1003A0	CONDENSATO RE CORAZZATO 6,3 UF	1	PZ	VI1931A0	DADO M8X1.65 H4 CH13 ZINCATO	1	PZ	VI1932A0	RONDELLA DENTELLATA D8 ZINCATA	1	PZ	VM1224A0	TUBOLARE TERMORETR 65MY 220MM 2 COLORI	0.200	M				
Codice	Descrizione	Qtà	UM																										
CN1003A0	CONDENSATO RE CORAZZATO 6,3 UF	1	PZ																										
VI1931A0	DADO M8X1.65 H4 CH13 ZINCATO	1	PZ																										
VI1932A0	RONDELLA DENTELLATA D8 ZINCATA	1	PZ																										
VM1224A0	TUBOLARE TERMORETR 65MY 220MM 2 COLORI	0.200	M																										
VM1750A	MORSETTO A PETTINE		KVM1750A	KIT MORSETTIERA A PETTINE	<table border="1"> <thead> <tr> <th>Codice</th> <th>Descrizione</th> <th>Qtà</th> <th>UM</th> </tr> </thead> <tbody> <tr> <td>VM1224A0</td> <td>TUBOLARE TERMORETR 65MY 220MM 2 COLORI</td> <td>0.150</td> <td>M</td> </tr> <tr> <td>VM1750A0</td> <td>MORSETTO A PETTINE</td> <td>1</td> <td>PZ</td> </tr> </tbody> </table>	Codice	Descrizione	Qtà	UM	VM1224A0	TUBOLARE TERMORETR 65MY 220MM 2 COLORI	0.150	M	VM1750A0	MORSETTO A PETTINE	1	PZ												
Codice	Descrizione	Qtà	UM																										
VM1224A0	TUBOLARE TERMORETR 65MY 220MM 2 COLORI	0.150	M																										
VM1750A0	MORSETTO A PETTINE	1	PZ																										
MR1004A	MORSETTIERA 7POLI 41A 450V		KMR1004A	KIT MORSETTIERA 7 POLI	<table border="1"> <thead> <tr> <th>Codice</th> <th>Descrizione</th> <th>Qtà</th> <th>UM</th> </tr> </thead> <tbody> <tr> <td>MR1004A1</td> <td>MORSETTIERA A 7POLI 41A 450V</td> <td>1</td> <td>PZ</td> </tr> <tr> <td>VM1224A0</td> <td>TUBOLARE TERMORETR 65MY 220MM 2 COLORI</td> <td>0.300</td> <td>M</td> </tr> </tbody> </table>	Codice	Descrizione	Qtà	UM	MR1004A1	MORSETTIERA A 7POLI 41A 450V	1	PZ	VM1224A0	TUBOLARE TERMORETR 65MY 220MM 2 COLORI	0.300	M												
Codice	Descrizione	Qtà	UM																										
MR1004A1	MORSETTIERA A 7POLI 41A 450V	1	PZ																										
VM1224A0	TUBOLARE TERMORETR 65MY 220MM 2 COLORI	0.300	M																										

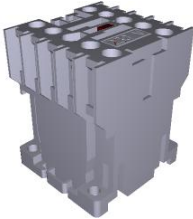
COMPONENTE			RICAMBIO																						
Codice	Descrizione	Immagine	Codice	Descrizione	Lista componenti																				
VM2191A	STAFFA TELERUTTORE GRANDE VE1095		VM2191A0	STAFFA TELERUTTORE GRANDE VE1095																					
VE1095A	TELERUTTORE GE 25A 230V 50/60		KVE1095A	KIT TELERUTTORE GE 25A 230V 50/60H	<table border="1"> <thead> <tr> <th>Codice</th> <th>Descrizione</th> <th>Qtà</th> <th>UM</th> </tr> </thead> <tbody> <tr> <td>VE1095A0</td> <td>TELERUTTORE E GE 25A 230V 50/60</td> <td>1</td> <td>PZ</td> </tr> <tr> <td>VM1075A1</td> <td>CLIP DI FISSAGGIO PER TELERUTTORI</td> <td>4</td> <td>PZ</td> </tr> <tr> <td>VM1224A0</td> <td>TUBOLARE TERMORETR 65MY 220MM 2 COLORI</td> <td>0.250</td> <td>M</td> </tr> </tbody> </table>	Codice	Descrizione	Qtà	UM	VE1095A0	TELERUTTORE E GE 25A 230V 50/60	1	PZ	VM1075A1	CLIP DI FISSAGGIO PER TELERUTTORI	4	PZ	VM1224A0	TUBOLARE TERMORETR 65MY 220MM 2 COLORI	0.250	M				
Codice	Descrizione	Qtà	UM																						
VE1095A0	TELERUTTORE E GE 25A 230V 50/60	1	PZ																						
VM1075A1	CLIP DI FISSAGGIO PER TELERUTTORI	4	PZ																						
VM1224A0	TUBOLARE TERMORETR 65MY 220MM 2 COLORI	0.250	M																						
VE1075A	PRESSACAVO DA PANNELLO PA6 UL94-V2		KVE1075A	KIT 10 PZ PRESSACAVO DA PANNELLO	<table border="1"> <thead> <tr> <th>Codice</th> <th>Descrizione</th> <th>Qtà</th> <th>UM</th> </tr> </thead> <tbody> <tr> <td>VE1075A0</td> <td>PRESSACAVO DA PANNELLO PA6 UL94-V2</td> <td>10</td> <td>PZ</td> </tr> <tr> <td>VM1224A0</td> <td>TUBOLARE TERMORETR 65MY 220MM 2 COLORI</td> <td>0.250</td> <td>M</td> </tr> </tbody> </table>	Codice	Descrizione	Qtà	UM	VE1075A0	PRESSACAVO DA PANNELLO PA6 UL94-V2	10	PZ	VM1224A0	TUBOLARE TERMORETR 65MY 220MM 2 COLORI	0.250	M								
Codice	Descrizione	Qtà	UM																						
VE1075A0	PRESSACAVO DA PANNELLO PA6 UL94-V2	10	PZ																						
VM1224A0	TUBOLARE TERMORETR 65MY 220MM 2 COLORI	0.250	M																						
VM1310A	SCATOLA COPRI MORSETTIERA XB/XV/XVC/XG		VM1310A0	SCATOLA COPRI MORSETTIERA XB/XV/XVC/XG																					
VE1615A	INVERTITORE DI MARCIA		KVE1615A	KIT INVERTITORE MARCIA VE1615A	<table border="1"> <thead> <tr> <th>Codice</th> <th>Descrizione</th> <th>Qtà</th> <th>UM</th> </tr> </thead> <tbody> <tr> <td>0H1429A0</td> <td>LAMIERINO FISSAGGIO INVERTITORE VE1615A</td> <td>1</td> <td>PZ</td> </tr> <tr> <td>VE1615A0</td> <td>INVERTITORE DI MARCIA</td> <td>1</td> <td>PZ</td> </tr> <tr> <td>VI1960A0</td> <td>VITE AUTOFIL. 4.2X11 TCBS+ AISI410</td> <td>3</td> <td>PZ</td> </tr> <tr> <td>VI1960A1</td> <td>VITE AUTOFIL. 4.2X9.5 TCBS+ ZN-NI</td> <td>3</td> <td>PZ</td> </tr> </tbody> </table>	Codice	Descrizione	Qtà	UM	0H1429A0	LAMIERINO FISSAGGIO INVERTITORE VE1615A	1	PZ	VE1615A0	INVERTITORE DI MARCIA	1	PZ	VI1960A0	VITE AUTOFIL. 4.2X11 TCBS+ AISI410	3	PZ	VI1960A1	VITE AUTOFIL. 4.2X9.5 TCBS+ ZN-NI	3	PZ
Codice	Descrizione	Qtà	UM																						
0H1429A0	LAMIERINO FISSAGGIO INVERTITORE VE1615A	1	PZ																						
VE1615A0	INVERTITORE DI MARCIA	1	PZ																						
VI1960A0	VITE AUTOFIL. 4.2X11 TCBS+ AISI410	3	PZ																						
VI1960A1	VITE AUTOFIL. 4.2X9.5 TCBS+ ZN-NI	3	PZ																						

COMPONENTE			RICAMBIO																		
Codice	Descrizione	Immagine	Codice	Descrizione	Lista componenti																
0H6770B	SUPPORTO COMPONENTI BL CL MANUAL		0H6770B0	SUPPORTO COMPONENTI BL CL MANUAL																	
0H6769A	LAMIERA FISSAGGIO CONNETTORI		0H6769B0	LAMIERA FISSAGGIO CONNETTORI																	
PE1782A	ALIMENTATORE 200-240VAC 12VCC 6VA		KPE1782A	KIT TRASF. 200-240VAC 12VCC BARRA LED	<table border="1"> <thead> <tr> <th>Codice</th> <th>Descrizione</th> <th>Qta</th> <th>UM</th> </tr> </thead> <tbody> <tr> <td>PE1782A0</td> <td>ALIMENTATO RE 200-240VAC 12VCC 6VA</td> <td>1</td> <td>PZ</td> </tr> <tr> <td>VM1745A0</td> <td>SUPPORTO PER SCHEDA</td> <td>4</td> <td>PZ</td> </tr> <tr> <td>VM2147A0</td> <td>SPUGNA ESD ROSA LISCIA 410X343X15 M</td> <td>1</td> <td>PZ</td> </tr> </tbody> </table>	Codice	Descrizione	Qta	UM	PE1782A0	ALIMENTATO RE 200-240VAC 12VCC 6VA	1	PZ	VM1745A0	SUPPORTO PER SCHEDA	4	PZ	VM2147A0	SPUGNA ESD ROSA LISCIA 410X343X15 M	1	PZ
Codice	Descrizione	Qta	UM																		
PE1782A0	ALIMENTATO RE 200-240VAC 12VCC 6VA	1	PZ																		
VM1745A0	SUPPORTO PER SCHEDA	4	PZ																		
VM2147A0	SPUGNA ESD ROSA LISCIA 410X343X15 M	1	PZ																		
VE1115A	MINICONTATTORE QUADRIPOLORE 20 A 230V		KVE1115A	KIT MINICONTATTORE QUADRIPOLORE 20A 230V	<table border="1"> <thead> <tr> <th>Codice</th> <th>Descrizione</th> <th>Qta</th> <th>UM</th> </tr> </thead> <tbody> <tr> <td>VE1115A0</td> <td>MINICONTATT ORE QUADRIPOLORE RE 20 A 230V</td> <td>1</td> <td>PZ</td> </tr> <tr> <td>VM1075A1</td> <td>CLIP DI FISSAGGIO PER TELERUTTORI</td> <td>4</td> <td>PZ</td> </tr> <tr> <td>VM1224A0</td> <td>TUBOLARE TERMORETR 65MY 220MM 2 COLORI</td> <td>0.250</td> <td>M</td> </tr> </tbody> </table>	Codice	Descrizione	Qta	UM	VE1115A0	MINICONTATT ORE QUADRIPOLORE RE 20 A 230V	1	PZ	VM1075A1	CLIP DI FISSAGGIO PER TELERUTTORI	4	PZ	VM1224A0	TUBOLARE TERMORETR 65MY 220MM 2 COLORI	0.250	M
Codice	Descrizione	Qta	UM																		
VE1115A0	MINICONTATT ORE QUADRIPOLORE RE 20 A 230V	1	PZ																		
VM1075A1	CLIP DI FISSAGGIO PER TELERUTTORI	4	PZ																		
VM1224A0	TUBOLARE TERMORETR 65MY 220MM 2 COLORI	0.250	M																		
VM1056A	STAFFA TELERUTTORE PICCOLO VE1115A		VM1056A0	STAFFA TELERUTTORE PICCOLO VE1115A																	

ASM4079A/0.D00 - Porta



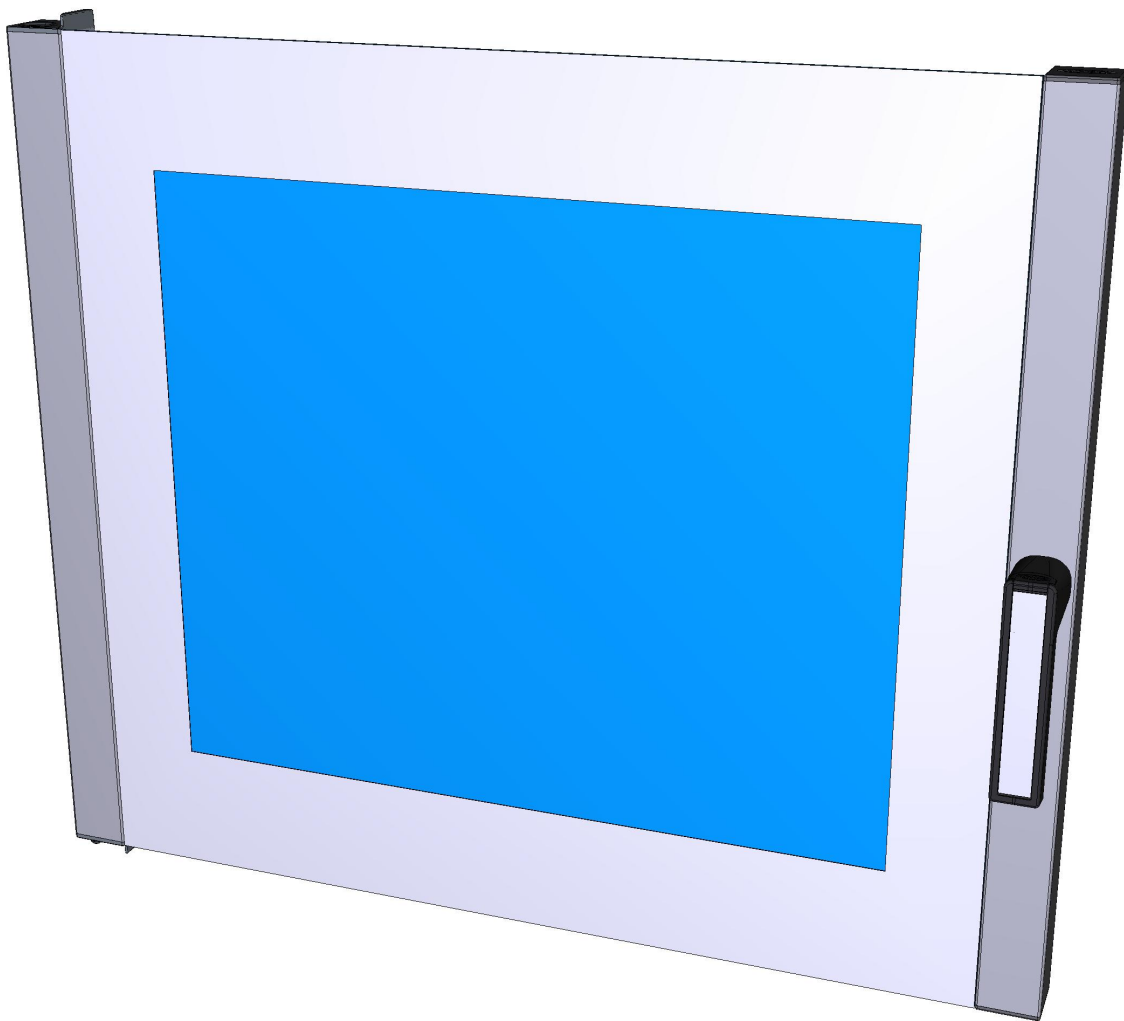

FRONTE



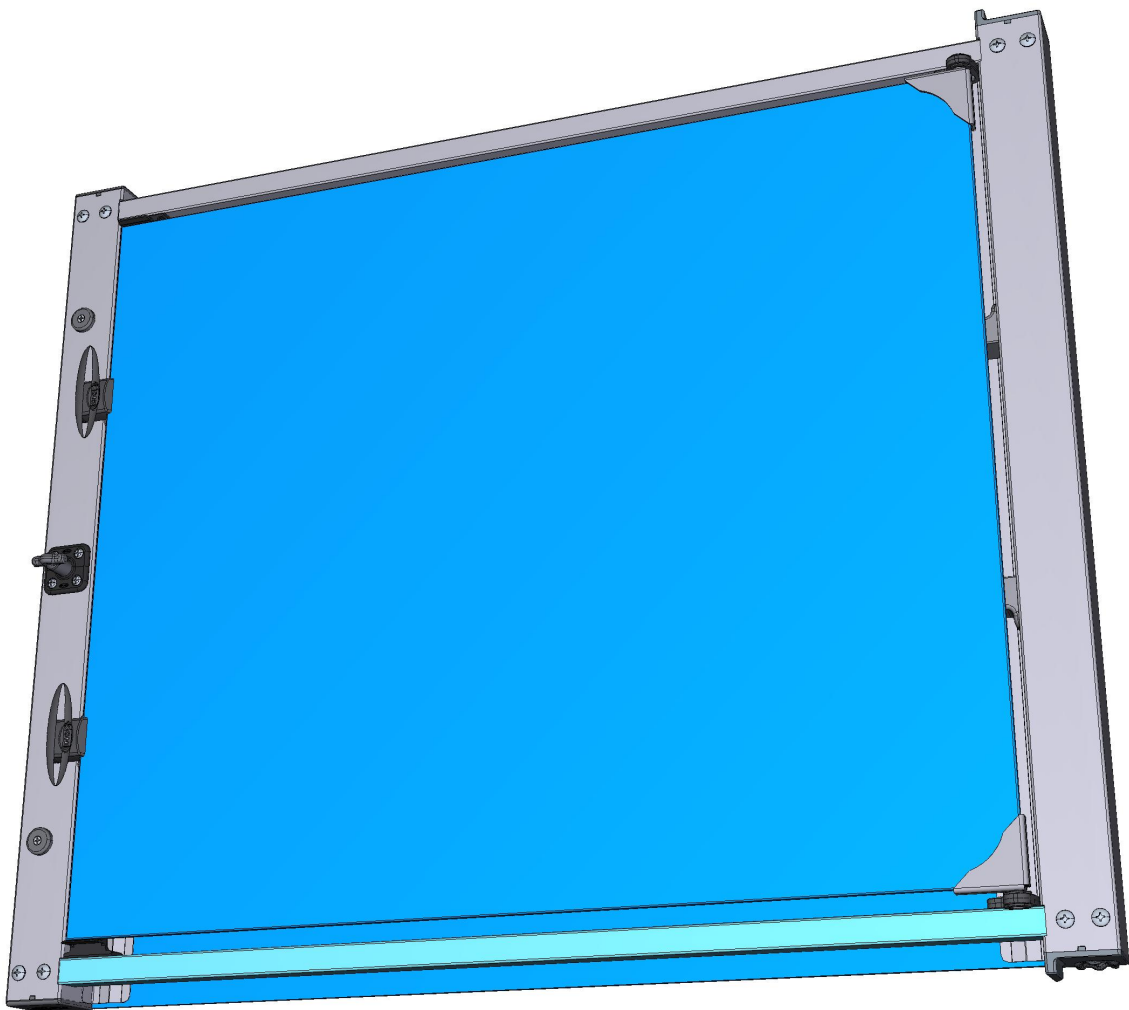



ASM4079A/0.D00 - Porta

RETRO

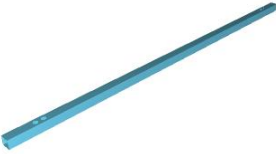







COMPONENTE			RICAMBIO														
Codice	Descrizione	Immagine	Codice	Descrizione	Lista componenti												
VM1511A	BOCCOLA LISCIA LUNGA PORTA CHEFFTOP		KVM1511A	KIT BOCCOLA VM1511A0 5PZ	<table border="1"> <thead> <tr> <th>Codice</th> <th>Descrizione</th> <th>Qtà</th> <th>UM</th> </tr> </thead> <tbody> <tr> <td>VM1224A0</td> <td>TUBOLARE TERMORETR 65MY 220MM 2 COLORI</td> <td>0.200</td> <td>M</td> </tr> <tr> <td>VM1511A0</td> <td>BOCCOLA LISCIA LUNGA PORTA CHEFFTOP</td> <td>5</td> <td>PZ</td> </tr> </tbody> </table>	Codice	Descrizione	Qtà	UM	VM1224A0	TUBOLARE TERMORETR 65MY 220MM 2 COLORI	0.200	M	VM1511A0	BOCCOLA LISCIA LUNGA PORTA CHEFFTOP	5	PZ
Codice	Descrizione	Qtà	UM														
VM1224A0	TUBOLARE TERMORETR 65MY 220MM 2 COLORI	0.200	M														
VM1511A0	BOCCOLA LISCIA LUNGA PORTA CHEFFTOP	5	PZ														
VM1510A	BOCCOLA SCANALATA LUNGA PORTA XBC/XVC		KVM1510A	KIT BOCCOLA VM1510A0 5 PZ	<table border="1"> <thead> <tr> <th>Codice</th> <th>Descrizione</th> <th>Qtà</th> <th>UM</th> </tr> </thead> <tbody> <tr> <td>VM1224A0</td> <td>TUBOLARE TERMORETR 65MY 220MM 2 COLORI</td> <td>0.150</td> <td>M</td> </tr> <tr> <td>VM1510A0</td> <td>BOCCOLA SCANALATA LUNGA PORTA XBC/XVC</td> <td>5</td> <td>PZ</td> </tr> </tbody> </table>	Codice	Descrizione	Qtà	UM	VM1224A0	TUBOLARE TERMORETR 65MY 220MM 2 COLORI	0.150	M	VM1510A0	BOCCOLA SCANALATA LUNGA PORTA XBC/XVC	5	PZ
Codice	Descrizione	Qtà	UM														
VM1224A0	TUBOLARE TERMORETR 65MY 220MM 2 COLORI	0.150	M														
VM1510A0	BOCCOLA SCANALATA LUNGA PORTA XBC/XVC	5	PZ														
TB3096A	COLONNINA DX PORTA BAKERLUX 6TG		TB3096A0	COLONNINA DX PORTA BAKERLUX 6TG													
TB3092A	COLONNINA SX PORTA BAKERLUX 6TG		TB3092A0	COLONNINA SX PORTA BAKERLUX 6TG													
TB2384B	LISTELLO SUPERIORE BL CL 20X20X1		TB2384B0	LISTELLO SUPERIORE BL CL 20X20X1													



COMPONENTE			RICAMBIO																																		
Codice	Descrizione	Immagine	Codice	Descrizione	Lista componenti																																
TB2404A	LISTELLO INFERIORE BL CL 20X20X1		TB2404A0	LISTELLO INFERIORE BL CL 20X20X1																																	
VT1255A	VETRO ESTERNO XB69- XC59-		KVT1255AR	KIT VETRO ESTERNO XB69-XV593 LED	<table border="1"> <thead> <tr> <th>Codice</th> <th>Descrizione</th> <th>Qtà</th> <th>UM</th> </tr> </thead> <tbody> <tr> <td>0H7529A0</td> <td>PROFILO INOX SUPPORTO VETRO EST XB69- XV</td> <td>2</td> <td>PZ</td> </tr> <tr> <td>IP1385A1</td> <td>IMB POL ANGOLARE 110X80X2000 D30</td> <td>1.540</td> <td>M</td> </tr> <tr> <td>IP1508A1</td> <td>POLISTIROLO PROFILO AD U 2000X60X60</td> <td>4.970</td> <td>M</td> </tr> <tr> <td>SL1156A0</td> <td>PUNTALE PER PISTOLA SILICONE BICOMPONEN</td> <td>1</td> <td>PZ</td> </tr> <tr> <td>VM1059A1</td> <td>FILM TERMORETRA IBILE H800</td> <td>1.800</td> <td>M</td> </tr> <tr> <td>VT1255A0</td> <td>VETRO ESTERNO XB69- XC59-</td> <td>1</td> <td>PZ</td> </tr> <tr> <td>VT1255A0</td> <td>VETRO ESTERNO XB69- XC59-</td> <td>1</td> <td>PZ</td> </tr> </tbody> </table>	Codice	Descrizione	Qtà	UM	0H7529A0	PROFILO INOX SUPPORTO VETRO EST XB69- XV	2	PZ	IP1385A1	IMB POL ANGOLARE 110X80X2000 D30	1.540	M	IP1508A1	POLISTIROLO PROFILO AD U 2000X60X60	4.970	M	SL1156A0	PUNTALE PER PISTOLA SILICONE BICOMPONEN	1	PZ	VM1059A1	FILM TERMORETRA IBILE H800	1.800	M	VT1255A0	VETRO ESTERNO XB69- XC59-	1	PZ	VT1255A0	VETRO ESTERNO XB69- XC59-	1	PZ
Codice	Descrizione	Qtà	UM																																		
0H7529A0	PROFILO INOX SUPPORTO VETRO EST XB69- XV	2	PZ																																		
IP1385A1	IMB POL ANGOLARE 110X80X2000 D30	1.540	M																																		
IP1508A1	POLISTIROLO PROFILO AD U 2000X60X60	4.970	M																																		
SL1156A0	PUNTALE PER PISTOLA SILICONE BICOMPONEN	1	PZ																																		
VM1059A1	FILM TERMORETRA IBILE H800	1.800	M																																		
VT1255A0	VETRO ESTERNO XB69- XC59-	1	PZ																																		
VT1255A0	VETRO ESTERNO XB69- XC59-	1	PZ																																		
			KVT1255A	KIT VETRO ESTERNO XB69- XV593	<table border="1"> <thead> <tr> <th>Codice</th> <th>Descrizione</th> <th>Qtà</th> <th>UM</th> </tr> </thead> <tbody> <tr> <td>0H6571A1</td> <td>PROFILO INOX SUPPORTO VETRO EST XB69- XV</td> <td>2</td> <td>PZ</td> </tr> <tr> <td>IP1385A1</td> <td>IMB POL ANGOLARE 110X80X2000 D30</td> <td>1.540</td> <td>M</td> </tr> <tr> <td>IP1508A1</td> <td>POLISTIROLO PROFILO AD U 2000X60X60</td> <td>1.270</td> <td>M</td> </tr> <tr> <td>SL1156A0</td> <td>PUNTALE PER PISTOLA SILICONE BICOMPONEN</td> <td>1</td> <td>PZ</td> </tr> <tr> <td>VT1255A0</td> <td>VETRO ESTERNO XB69- XC59-</td> <td>1</td> <td>PZ</td> </tr> <tr> <td>VT1255A0</td> <td>VETRO ESTERNO XB69- XC59-</td> <td>1</td> <td>PZ</td> </tr> </tbody> </table>	Codice	Descrizione	Qtà	UM	0H6571A1	PROFILO INOX SUPPORTO VETRO EST XB69- XV	2	PZ	IP1385A1	IMB POL ANGOLARE 110X80X2000 D30	1.540	M	IP1508A1	POLISTIROLO PROFILO AD U 2000X60X60	1.270	M	SL1156A0	PUNTALE PER PISTOLA SILICONE BICOMPONEN	1	PZ	VT1255A0	VETRO ESTERNO XB69- XC59-	1	PZ	VT1255A0	VETRO ESTERNO XB69- XC59-	1	PZ				
Codice	Descrizione	Qtà	UM																																		
0H6571A1	PROFILO INOX SUPPORTO VETRO EST XB69- XV	2	PZ																																		
IP1385A1	IMB POL ANGOLARE 110X80X2000 D30	1.540	M																																		
IP1508A1	POLISTIROLO PROFILO AD U 2000X60X60	1.270	M																																		
SL1156A0	PUNTALE PER PISTOLA SILICONE BICOMPONEN	1	PZ																																		
VT1255A0	VETRO ESTERNO XB69- XC59-	1	PZ																																		
VT1255A0	VETRO ESTERNO XB69- XC59-	1	PZ																																		



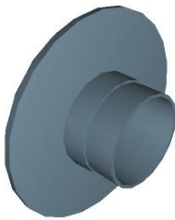

COMPONENTE			RICAMBIO																																																														
Codice	Descrizione	Immagine	Codice	Descrizione	Lista componenti																																																												
VM1977A	TAPPO FULCRO SUPERIORE PORTA CL BL		KVM1977A	KIT TAPPO FULCRO SUPERIORE PORTA CL BL	<table border="1"> <thead> <tr> <th>Codice</th> <th>Descrizione</th> <th>Qtà</th> <th>UM</th> </tr> </thead> <tbody> <tr> <td>VM1224A0</td> <td>TUBOLARE TERMORETR 65MY 220MM 2 COLORI</td> <td>0.250</td> <td>M</td> </tr> <tr> <td>VM1977A0</td> <td>TAPPO FULCRO SUPERIORE PORTA CL BL</td> <td>1</td> <td>PZ</td> </tr> </tbody> </table>	Codice	Descrizione	Qtà	UM	VM1224A0	TUBOLARE TERMORETR 65MY 220MM 2 COLORI	0.250	M	VM1977A0	TAPPO FULCRO SUPERIORE PORTA CL BL	1	PZ																																																
Codice	Descrizione	Qtà	UM																																																														
VM1224A0	TUBOLARE TERMORETR 65MY 220MM 2 COLORI	0.250	M																																																														
VM1977A0	TAPPO FULCRO SUPERIORE PORTA CL BL	1	PZ																																																														
VM1978A	TAPPO FULCRO INFERIORE PORTA CL BL		KDR1254A	PORTA COMPLETA XB893 XV893	<table border="1"> <thead> <tr> <th>Codice</th> <th>Descrizione</th> <th>Qtà</th> <th>UM</th> </tr> </thead> <tbody> <tr> <td>0H6575A1</td> <td>PROFILO INOX SUPPORTO VETRO EST XB89- XV</td> <td>2</td> <td>PZ</td> </tr> <tr> <td>0H7321A0</td> <td>PIASTRINA COPERCHIETT O MANIGLIA M</td> <td>1</td> <td>PZ</td> </tr> <tr> <td>CR1085A0</td> <td>CERNIERA VETRO INT INOX SUP</td> <td>1</td> <td>PZ</td> </tr> <tr> <td>CR1086A0</td> <td>CERNIERA VETRO INT INOX INF</td> <td>1</td> <td>PZ</td> </tr> <tr> <td>ED1072A0</td> <td>ETICHETTA MANIGLIA LUX</td> <td>1</td> <td>PZ</td> </tr> <tr> <td>GN1181A0</td> <td>GUARNIZIONE CERN VETRO INT CR1085-1086</td> <td>2</td> <td>PZ</td> </tr> <tr> <td>IL1206C0</td> <td>PALETTA LEGNO 968X1053 H126 XBC</td> <td>1</td> <td>PZ</td> </tr> <tr> <td>RC1200A0</td> <td>MOLLA A COMPRESSIO NE DE4 DF0.5 H24</td> <td>8</td> <td>PZ</td> </tr> <tr> <td>SL1110A0</td> <td>TONDINO BIADESIVO 3M VHB 9473-PC</td> <td>1</td> <td>PZ</td> </tr> <tr> <td>TB2384B0</td> <td>LISTELLO SUPERIORE BL CL 20X20X1</td> <td>1</td> <td>PZ</td> </tr> <tr> <td>TB2385A0</td> <td>COLONNINA DX BL CL 89 50X50X1.2</td> <td>1</td> <td>PZ</td> </tr> <tr> <td>TB2386A0</td> <td>COLONNINA SX BL CL 89 50X50X1.2</td> <td>1</td> <td>PZ</td> </tr> <tr> <td>TB2404A0</td> <td>LISTELLO INFERIORE BL CL 20X20X1</td> <td>1</td> <td>PZ</td> </tr> <tr> <td>VI0239A1</td> <td>VITE AUTOFIL. 4.2X25 TCB+ INOX</td> <td>4</td> <td>PZ</td> </tr> </tbody> </table>	Codice	Descrizione	Qtà	UM	0H6575A1	PROFILO INOX SUPPORTO VETRO EST XB89- XV	2	PZ	0H7321A0	PIASTRINA COPERCHIETT O MANIGLIA M	1	PZ	CR1085A0	CERNIERA VETRO INT INOX SUP	1	PZ	CR1086A0	CERNIERA VETRO INT INOX INF	1	PZ	ED1072A0	ETICHETTA MANIGLIA LUX	1	PZ	GN1181A0	GUARNIZIONE CERN VETRO INT CR1085-1086	2	PZ	IL1206C0	PALETTA LEGNO 968X1053 H126 XBC	1	PZ	RC1200A0	MOLLA A COMPRESSIO NE DE4 DF0.5 H24	8	PZ	SL1110A0	TONDINO BIADESIVO 3M VHB 9473-PC	1	PZ	TB2384B0	LISTELLO SUPERIORE BL CL 20X20X1	1	PZ	TB2385A0	COLONNINA DX BL CL 89 50X50X1.2	1	PZ	TB2386A0	COLONNINA SX BL CL 89 50X50X1.2	1	PZ	TB2404A0	LISTELLO INFERIORE BL CL 20X20X1	1	PZ	VI0239A1	VITE AUTOFIL. 4.2X25 TCB+ INOX	4	PZ
Codice	Descrizione	Qtà	UM																																																														
0H6575A1	PROFILO INOX SUPPORTO VETRO EST XB89- XV	2	PZ																																																														
0H7321A0	PIASTRINA COPERCHIETT O MANIGLIA M	1	PZ																																																														
CR1085A0	CERNIERA VETRO INT INOX SUP	1	PZ																																																														
CR1086A0	CERNIERA VETRO INT INOX INF	1	PZ																																																														
ED1072A0	ETICHETTA MANIGLIA LUX	1	PZ																																																														
GN1181A0	GUARNIZIONE CERN VETRO INT CR1085-1086	2	PZ																																																														
IL1206C0	PALETTA LEGNO 968X1053 H126 XBC	1	PZ																																																														
RC1200A0	MOLLA A COMPRESSIO NE DE4 DF0.5 H24	8	PZ																																																														
SL1110A0	TONDINO BIADESIVO 3M VHB 9473-PC	1	PZ																																																														
TB2384B0	LISTELLO SUPERIORE BL CL 20X20X1	1	PZ																																																														
TB2385A0	COLONNINA DX BL CL 89 50X50X1.2	1	PZ																																																														
TB2386A0	COLONNINA SX BL CL 89 50X50X1.2	1	PZ																																																														
TB2404A0	LISTELLO INFERIORE BL CL 20X20X1	1	PZ																																																														
VI0239A1	VITE AUTOFIL. 4.2X25 TCB+ INOX	4	PZ																																																														

COMPONENTE			RICAMBIO																																																																						
Codice	Descrizione	Immagine	Codice	Descrizione	Lista componenti																																																																				
VM1978A	TAPPO FULCRO INFERIORE PORTA CL BL		KDR1254A	PORTA COMPLETA XB893 XV893	<table border="1"> <thead> <tr> <th>Codice</th> <th>Descrizione</th> <th>Qtà</th> <th>UM</th> </tr> </thead> <tbody> <tr> <td>VI1070A0</td> <td>VITE M4X16 TSP+ UNI7688 INOX</td> <td>1</td> <td>PZ</td> </tr> <tr> <td>VI1075A0</td> <td>DADO M4 H=4 INOX UNI5587</td> <td>1</td> <td>PZ</td> </tr> <tr> <td>VI1220A1</td> <td>VITE AUTOFILETTA NTE 4.2X11 TCS+ MARUTE</td> <td>28</td> <td>PZ</td> </tr> <tr> <td>VI1300A0</td> <td>VITE M6X12 T1/2T+ INOX</td> <td>12</td> <td>PZ</td> </tr> <tr> <td>VI1310A0</td> <td>INSERTO FILETTATO M6 FTR/E ZN</td> <td>8</td> <td>PZ</td> </tr> <tr> <td>VI1340A0</td> <td>INSERTO FILETTATO M6 FTT/E INOX</td> <td>4</td> <td>PZ</td> </tr> <tr> <td>VI1810A0</td> <td>VITE NO TESTA EI M6X6 TESTA PIANA INOX</td> <td>6</td> <td>PZ</td> </tr> <tr> <td>VM1182B1</td> <td>ATTACCO MANIGLIA CON GUIDA PERNO CT BT</td> <td>1</td> <td>PZ</td> </tr> <tr> <td>VM1183B0</td> <td>PERNO MANIGLIA CT BT</td> <td>1</td> <td>PZ</td> </tr> <tr> <td>VM1183B1</td> <td>PERNO MANIGLIA CT BT</td> <td>1</td> <td>PZ</td> </tr> <tr> <td>VM1183C0</td> <td>PERNO MANIGLIA CT BT</td> <td>1</td> <td>PZ</td> </tr> <tr> <td>VM1490A0</td> <td>COPRI VITI MANIGLIA CHEFTOP BAKERTOP</td> <td>2</td> <td>PZ</td> </tr> <tr> <td>VM1510A0</td> <td>BOCCOLA SCANALATA LUNGA PORTA XBC/XVC</td> <td>1</td> <td>PZ</td> </tr> <tr> <td>VM1511A0</td> <td>BOCCOLA LISCIA LUNGA PORTA CHEFTOP</td> <td>1</td> <td>PZ</td> </tr> <tr> <td>VM1591A0</td> <td>STAFFA SPINGIVETRO INTERNO XVC1004</td> <td>1</td> <td>PZ</td> </tr> <tr> <td>VM1630A0</td> <td>TAPPO PREMI VETRO INTERNO</td> <td>2</td> <td>PZ</td> </tr> </tbody> </table>	Codice	Descrizione	Qtà	UM	VI1070A0	VITE M4X16 TSP+ UNI7688 INOX	1	PZ	VI1075A0	DADO M4 H=4 INOX UNI5587	1	PZ	VI1220A1	VITE AUTOFILETTA NTE 4.2X11 TCS+ MARUTE	28	PZ	VI1300A0	VITE M6X12 T1/2T+ INOX	12	PZ	VI1310A0	INSERTO FILETTATO M6 FTR/E ZN	8	PZ	VI1340A0	INSERTO FILETTATO M6 FTT/E INOX	4	PZ	VI1810A0	VITE NO TESTA EI M6X6 TESTA PIANA INOX	6	PZ	VM1182B1	ATTACCO MANIGLIA CON GUIDA PERNO CT BT	1	PZ	VM1183B0	PERNO MANIGLIA CT BT	1	PZ	VM1183B1	PERNO MANIGLIA CT BT	1	PZ	VM1183C0	PERNO MANIGLIA CT BT	1	PZ	VM1490A0	COPRI VITI MANIGLIA CHEFTOP BAKERTOP	2	PZ	VM1510A0	BOCCOLA SCANALATA LUNGA PORTA XBC/XVC	1	PZ	VM1511A0	BOCCOLA LISCIA LUNGA PORTA CHEFTOP	1	PZ	VM1591A0	STAFFA SPINGIVETRO INTERNO XVC1004	1	PZ	VM1630A0	TAPPO PREMI VETRO INTERNO	2	PZ
Codice	Descrizione	Qtà	UM																																																																						
VI1070A0	VITE M4X16 TSP+ UNI7688 INOX	1	PZ																																																																						
VI1075A0	DADO M4 H=4 INOX UNI5587	1	PZ																																																																						
VI1220A1	VITE AUTOFILETTA NTE 4.2X11 TCS+ MARUTE	28	PZ																																																																						
VI1300A0	VITE M6X12 T1/2T+ INOX	12	PZ																																																																						
VI1310A0	INSERTO FILETTATO M6 FTR/E ZN	8	PZ																																																																						
VI1340A0	INSERTO FILETTATO M6 FTT/E INOX	4	PZ																																																																						
VI1810A0	VITE NO TESTA EI M6X6 TESTA PIANA INOX	6	PZ																																																																						
VM1182B1	ATTACCO MANIGLIA CON GUIDA PERNO CT BT	1	PZ																																																																						
VM1183B0	PERNO MANIGLIA CT BT	1	PZ																																																																						
VM1183B1	PERNO MANIGLIA CT BT	1	PZ																																																																						
VM1183C0	PERNO MANIGLIA CT BT	1	PZ																																																																						
VM1490A0	COPRI VITI MANIGLIA CHEFTOP BAKERTOP	2	PZ																																																																						
VM1510A0	BOCCOLA SCANALATA LUNGA PORTA XBC/XVC	1	PZ																																																																						
VM1511A0	BOCCOLA LISCIA LUNGA PORTA CHEFTOP	1	PZ																																																																						
VM1591A0	STAFFA SPINGIVETRO INTERNO XVC1004	1	PZ																																																																						
VM1630A0	TAPPO PREMI VETRO INTERNO	2	PZ																																																																						

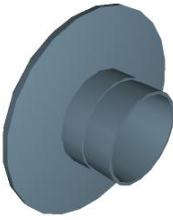

COMPONENTE			RICAMBIO																																																																		
Codice	Descrizione	Immagine	Codice	Descrizione	Lista componenti																																																																
VM1978A	TAPPO FULCRO INFERIORE PORTA CL BL		KDR1254A	PORTA COMPLETA XB893 XV893	<table border="1"> <thead> <tr> <th>Codice</th> <th>Descrizione</th> <th>Qtà</th> <th>UM</th> </tr> </thead> <tbody> <tr> <td>VM1630A1</td> <td>TAPPO PREMI VETRO INTERNO</td> <td>2</td> <td>PZ</td> </tr> <tr> <td>VM1680A0</td> <td>CERNIERA APERTURA VETRO INTERNO</td> <td>2</td> <td>PZ</td> </tr> <tr> <td>VM1695A0</td> <td>PERNO POSIZIONE MANIGLIA</td> <td>4</td> <td>PZ</td> </tr> <tr> <td>VM1976A0</td> <td>TAPPO ESTETICO COLONNINA PORTA CL BL</td> <td>2</td> <td>PZ</td> </tr> <tr> <td>VM1977A0</td> <td>TAPPO FULCRO SUPERIORE PORTA CL BL</td> <td>1</td> <td>PZ</td> </tr> <tr> <td>VM1978A0</td> <td>TAPPO FULCRO INFERIORE PORTA CL BL</td> <td>1</td> <td>PZ</td> </tr> <tr> <td>VM2000A0</td> <td>TAPPO COPRIVITE A BRUGOLA M4</td> <td>6</td> <td>PZ</td> </tr> <tr> <td>VM2008A0</td> <td>DISTANZIALE PER MICROPORTA MECC</td> <td>1</td> <td>PZ</td> </tr> <tr> <td>VM2042A0</td> <td>ASSIEME CHIUSURA VETRO INTERNO LAT</td> <td>2</td> <td>PZ</td> </tr> <tr> <td>VM2043A0</td> <td>SUPPORTO VETRO SUP - INF</td> <td>2</td> <td>PZ</td> </tr> <tr> <td>VM2245A0</td> <td>IMPUGNATUR A MANIGLIA CON SCROCC</td> <td>1</td> <td>PZ</td> </tr> <tr> <td>VM2247A0</td> <td>COVER IMPUGNATUR A MANIGLIA VM2245-2246</td> <td>1</td> <td>PZ</td> </tr> <tr> <td>VM2247B0</td> <td>COVER IMPUGNATUR A MANIGLIA VM2245-2246</td> <td>1</td> <td>PZ</td> </tr> <tr> <td>VT1140A0</td> <td>VETRO INTERNO 743X940X6 BETFL</td> <td>1</td> <td>PZ</td> </tr> <tr> <td>VT1140A0</td> <td>VETRO INTERNO 743X940X6 BETFL</td> <td>1</td> <td>PZ</td> </tr> </tbody> </table>	Codice	Descrizione	Qtà	UM	VM1630A1	TAPPO PREMI VETRO INTERNO	2	PZ	VM1680A0	CERNIERA APERTURA VETRO INTERNO	2	PZ	VM1695A0	PERNO POSIZIONE MANIGLIA	4	PZ	VM1976A0	TAPPO ESTETICO COLONNINA PORTA CL BL	2	PZ	VM1977A0	TAPPO FULCRO SUPERIORE PORTA CL BL	1	PZ	VM1978A0	TAPPO FULCRO INFERIORE PORTA CL BL	1	PZ	VM2000A0	TAPPO COPRIVITE A BRUGOLA M4	6	PZ	VM2008A0	DISTANZIALE PER MICROPORTA MECC	1	PZ	VM2042A0	ASSIEME CHIUSURA VETRO INTERNO LAT	2	PZ	VM2043A0	SUPPORTO VETRO SUP - INF	2	PZ	VM2245A0	IMPUGNATUR A MANIGLIA CON SCROCC	1	PZ	VM2247A0	COVER IMPUGNATUR A MANIGLIA VM2245-2246	1	PZ	VM2247B0	COVER IMPUGNATUR A MANIGLIA VM2245-2246	1	PZ	VT1140A0	VETRO INTERNO 743X940X6 BETFL	1	PZ	VT1140A0	VETRO INTERNO 743X940X6 BETFL	1	PZ
Codice	Descrizione	Qtà	UM																																																																		
VM1630A1	TAPPO PREMI VETRO INTERNO	2	PZ																																																																		
VM1680A0	CERNIERA APERTURA VETRO INTERNO	2	PZ																																																																		
VM1695A0	PERNO POSIZIONE MANIGLIA	4	PZ																																																																		
VM1976A0	TAPPO ESTETICO COLONNINA PORTA CL BL	2	PZ																																																																		
VM1977A0	TAPPO FULCRO SUPERIORE PORTA CL BL	1	PZ																																																																		
VM1978A0	TAPPO FULCRO INFERIORE PORTA CL BL	1	PZ																																																																		
VM2000A0	TAPPO COPRIVITE A BRUGOLA M4	6	PZ																																																																		
VM2008A0	DISTANZIALE PER MICROPORTA MECC	1	PZ																																																																		
VM2042A0	ASSIEME CHIUSURA VETRO INTERNO LAT	2	PZ																																																																		
VM2043A0	SUPPORTO VETRO SUP - INF	2	PZ																																																																		
VM2245A0	IMPUGNATUR A MANIGLIA CON SCROCC	1	PZ																																																																		
VM2247A0	COVER IMPUGNATUR A MANIGLIA VM2245-2246	1	PZ																																																																		
VM2247B0	COVER IMPUGNATUR A MANIGLIA VM2245-2246	1	PZ																																																																		
VT1140A0	VETRO INTERNO 743X940X6 BETFL	1	PZ																																																																		
VT1140A0	VETRO INTERNO 743X940X6 BETFL	1	PZ																																																																		

COMPONENTE			RICAMBIO																						
Codice	Descrizione	Immagine	Codice	Descrizione	Lista componenti																				
VM1978A	TAPPO FULCRO INFERIORE PORTA CL BL		KDR1254A	PORTA COMPLETA XB893 XV893	<table border="1"> <thead> <tr> <th>Codice</th> <th>Descrizione</th> <th>Qtà</th> <th>UM</th> </tr> </thead> <tbody> <tr> <td>VT1254A0</td> <td>VETRO ESTERNO XB89- XC89-</td> <td>1</td> <td>PZ</td> </tr> <tr> <td>VT1254A0</td> <td>VETRO ESTERNO XB89- XC89-</td> <td>1</td> <td>PZ</td> </tr> </tbody> </table>	Codice	Descrizione	Qtà	UM	VT1254A0	VETRO ESTERNO XB89- XC89-	1	PZ	VT1254A0	VETRO ESTERNO XB89- XC89-	1	PZ								
Codice	Descrizione	Qtà	UM																						
VT1254A0	VETRO ESTERNO XB89- XC89-	1	PZ																						
VT1254A0	VETRO ESTERNO XB89- XC89-	1	PZ																						
VM1976A	TAPPO ESTETICO COLONNINA PORTA CL BL		KVM1976A	KIT TAPPO ESTETICO COLONNINA PORTA CL BL	<table border="1"> <thead> <tr> <th>Codice</th> <th>Descrizione</th> <th>Qtà</th> <th>UM</th> </tr> </thead> <tbody> <tr> <td>VM1224A0</td> <td>TUBOLARE TERMORETR 65MY 220MM 2 COLORI</td> <td>0.200</td> <td>M</td> </tr> <tr> <td>VM1976A0</td> <td>TAPPO ESTETICO COLONNINA PORTA CL BL</td> <td>1</td> <td>PZ</td> </tr> </tbody> </table>	Codice	Descrizione	Qtà	UM	VM1224A0	TUBOLARE TERMORETR 65MY 220MM 2 COLORI	0.200	M	VM1976A0	TAPPO ESTETICO COLONNINA PORTA CL BL	1	PZ								
Codice	Descrizione	Qtà	UM																						
VM1224A0	TUBOLARE TERMORETR 65MY 220MM 2 COLORI	0.200	M																						
VM1976A0	TAPPO ESTETICO COLONNINA PORTA CL BL	1	PZ																						
VM1680A	CERNIERA APERTURA VETRO INTERNO		KVM1680A	KIT 2 PZ SOSTEGNO CERNIERA VETRO INT	<table border="1"> <thead> <tr> <th>Codice</th> <th>Descrizione</th> <th>Qtà</th> <th>UM</th> </tr> </thead> <tbody> <tr> <td>VM1224A0</td> <td>TUBOLARE TERMORETR 65MY 220MM 2 COLORI</td> <td>0.200</td> <td>M</td> </tr> <tr> <td>VM1680A0</td> <td>CERNIERA APERTURA VETRO INTERNO</td> <td>2</td> <td>PZ</td> </tr> </tbody> </table>	Codice	Descrizione	Qtà	UM	VM1224A0	TUBOLARE TERMORETR 65MY 220MM 2 COLORI	0.200	M	VM1680A0	CERNIERA APERTURA VETRO INTERNO	2	PZ								
Codice	Descrizione	Qtà	UM																						
VM1224A0	TUBOLARE TERMORETR 65MY 220MM 2 COLORI	0.200	M																						
VM1680A0	CERNIERA APERTURA VETRO INTERNO	2	PZ																						
VM2043A	SUPPORTO VETRO SUP - INF		KVM2043A	KIT 2 PZ SUPPORTO VETRO SUP - INF	<table border="1"> <thead> <tr> <th>Codice</th> <th>Descrizione</th> <th>Qtà</th> <th>UM</th> </tr> </thead> <tbody> <tr> <td>VM1224A0</td> <td>TUBOLARE TERMORETR 65MY 220MM 2 COLORI</td> <td>0.150</td> <td>M</td> </tr> <tr> <td>VM2043A0</td> <td>SUPPORTO VETRO SUP - INF</td> <td>2</td> <td>PZ</td> </tr> </tbody> </table>	Codice	Descrizione	Qtà	UM	VM1224A0	TUBOLARE TERMORETR 65MY 220MM 2 COLORI	0.150	M	VM2043A0	SUPPORTO VETRO SUP - INF	2	PZ								
Codice	Descrizione	Qtà	UM																						
VM1224A0	TUBOLARE TERMORETR 65MY 220MM 2 COLORI	0.150	M																						
VM2043A0	SUPPORTO VETRO SUP - INF	2	PZ																						
VT1135A	VETRO INTERNO 743X620X6		KVT1135A	KIT VETRO INTERNO XB693/5 XBC605 XVC1205	<table border="1"> <thead> <tr> <th>Codice</th> <th>Descrizione</th> <th>Qtà</th> <th>UM</th> </tr> </thead> <tbody> <tr> <td>IP1508A1</td> <td>POLISTIROLO PROFILO AD U 2000X60X60</td> <td>2</td> <td>M</td> </tr> <tr> <td>VM1059A1</td> <td>FILM TERMORETRA IBILE H800</td> <td>1.500</td> <td>M</td> </tr> <tr> <td>VT1135A0</td> <td>VETRO INTERNO 743X620X6</td> <td>1</td> <td>PZ</td> </tr> <tr> <td>VT1135A0</td> <td>VETRO INTERNO 743X620X6</td> <td>1</td> <td>PZ</td> </tr> </tbody> </table>	Codice	Descrizione	Qtà	UM	IP1508A1	POLISTIROLO PROFILO AD U 2000X60X60	2	M	VM1059A1	FILM TERMORETRA IBILE H800	1.500	M	VT1135A0	VETRO INTERNO 743X620X6	1	PZ	VT1135A0	VETRO INTERNO 743X620X6	1	PZ
Codice	Descrizione	Qtà	UM																						
IP1508A1	POLISTIROLO PROFILO AD U 2000X60X60	2	M																						
VM1059A1	FILM TERMORETRA IBILE H800	1.500	M																						
VT1135A0	VETRO INTERNO 743X620X6	1	PZ																						
VT1135A0	VETRO INTERNO 743X620X6	1	PZ																						

COMPONENTE			RICAMBIO																																																		
Codice	Descrizione	Immagine	Codice	Descrizione	Lista componenti																																																
VM2000A	TAPPO COPRIVITE A BRUGOLA M4		VM2000A0	TAPPO COPRIVITE A BRUGOLA M4																																																	
CR1085A	CERNIERA VETRO INT INOX SUP		KVM0012A	KIT CONV. APERTURA VETRO INT. S. 4-5-5E	<table border="1"> <thead> <tr> <th>Codice</th> <th>Descrizione</th> <th>Qtà</th> <th>UM</th> </tr> </thead> <tbody> <tr> <td>CR1085A0</td> <td>CERNIERA VETRO INT INOX SUP</td> <td>1</td> <td>PZ</td> </tr> <tr> <td>CR1086A0</td> <td>CERNIERA VETRO INT INOX INF</td> <td>1</td> <td>PZ</td> </tr> <tr> <td>GN1181A0</td> <td>GUARNIZIONE CERN VETRO INT CR1085-1086</td> <td>2</td> <td>PZ</td> </tr> <tr> <td>VI1220A1</td> <td>VITE AUTOFISETTA NTE 4.2X11 TCS+ MARUTE</td> <td>5</td> <td>PZ</td> </tr> <tr> <td>VI1300A0</td> <td>VITE M6X12 T1/2T+ INOX</td> <td>4</td> <td>PZ</td> </tr> <tr> <td>VI1810A0</td> <td>VITE NO TESTA EI M6X6 TESTA PIANA INOX</td> <td>6</td> <td>PZ</td> </tr> <tr> <td>VI1950A0</td> <td>VITE AUTOFORANT E 4,2X13 TCB INOX</td> <td>6</td> <td>PZ</td> </tr> <tr> <td>VM1224A0</td> <td>TUBOLARE TERMORETR 65MY 220MM 2 COLORI</td> <td>0.300</td> <td>M</td> </tr> <tr> <td>VM1680A0</td> <td>CERNIERA APERTURA VETRO INTERNO</td> <td>2</td> <td>PZ</td> </tr> <tr> <td>VM2042A0</td> <td>ASSIEME CHIUSURA VETRO INTERNO LAT</td> <td>2</td> <td>PZ</td> </tr> <tr> <td>VM2043A0</td> <td>SUPPORTO VETRO SUP - INF</td> <td>2</td> <td>PZ</td> </tr> </tbody> </table>	Codice	Descrizione	Qtà	UM	CR1085A0	CERNIERA VETRO INT INOX SUP	1	PZ	CR1086A0	CERNIERA VETRO INT INOX INF	1	PZ	GN1181A0	GUARNIZIONE CERN VETRO INT CR1085-1086	2	PZ	VI1220A1	VITE AUTOFISETTA NTE 4.2X11 TCS+ MARUTE	5	PZ	VI1300A0	VITE M6X12 T1/2T+ INOX	4	PZ	VI1810A0	VITE NO TESTA EI M6X6 TESTA PIANA INOX	6	PZ	VI1950A0	VITE AUTOFORANT E 4,2X13 TCB INOX	6	PZ	VM1224A0	TUBOLARE TERMORETR 65MY 220MM 2 COLORI	0.300	M	VM1680A0	CERNIERA APERTURA VETRO INTERNO	2	PZ	VM2042A0	ASSIEME CHIUSURA VETRO INTERNO LAT	2	PZ	VM2043A0	SUPPORTO VETRO SUP - INF	2	PZ
Codice	Descrizione	Qtà	UM																																																		
CR1085A0	CERNIERA VETRO INT INOX SUP	1	PZ																																																		
CR1086A0	CERNIERA VETRO INT INOX INF	1	PZ																																																		
GN1181A0	GUARNIZIONE CERN VETRO INT CR1085-1086	2	PZ																																																		
VI1220A1	VITE AUTOFISETTA NTE 4.2X11 TCS+ MARUTE	5	PZ																																																		
VI1300A0	VITE M6X12 T1/2T+ INOX	4	PZ																																																		
VI1810A0	VITE NO TESTA EI M6X6 TESTA PIANA INOX	6	PZ																																																		
VI1950A0	VITE AUTOFORANT E 4,2X13 TCB INOX	6	PZ																																																		
VM1224A0	TUBOLARE TERMORETR 65MY 220MM 2 COLORI	0.300	M																																																		
VM1680A0	CERNIERA APERTURA VETRO INTERNO	2	PZ																																																		
VM2042A0	ASSIEME CHIUSURA VETRO INTERNO LAT	2	PZ																																																		
VM2043A0	SUPPORTO VETRO SUP - INF	2	PZ																																																		
			KCR1085A	KIT CERNIERA VETRO INT INOX SU	<table border="1"> <thead> <tr> <th>Codice</th> <th>Descrizione</th> <th>Qtà</th> <th>UM</th> </tr> </thead> <tbody> <tr> <td>CR1085A0</td> <td>CERNIERA VETRO INT INOX SUP</td> <td>1</td> <td>PZ</td> </tr> </tbody> </table>	Codice	Descrizione	Qtà	UM	CR1085A0	CERNIERA VETRO INT INOX SUP	1	PZ																																								
Codice	Descrizione	Qtà	UM																																																		
CR1085A0	CERNIERA VETRO INT INOX SUP	1	PZ																																																		



COMPONENTE			RICAMBIO																		
Codice	Descrizione	Immagine	Codice	Descrizione	Lista componenti																
CR1085A	CERNIERA VETRO INT INOX SUP		KCR1085A	KIT CERNIERA VETRO INT INOX SU	<table border="1"> <thead> <tr> <th>Codice</th> <th>Descrizione</th> <th>Qtà</th> <th>UM</th> </tr> </thead> <tbody> <tr> <td>GN1181A0</td> <td>GUARNIZIONE CERN VETRO INT CR1085-1086</td> <td>1</td> <td>PZ</td> </tr> <tr> <td>V11810A0</td> <td>VITE NO TESTA EI M6X6 TESTA PIANA INOX</td> <td>3</td> <td>PZ</td> </tr> <tr> <td>VM1224A0</td> <td>TUBOLARE TERMORETR 65MY 220MM 2 COLORI</td> <td>0.200</td> <td>M</td> </tr> </tbody> </table>	Codice	Descrizione	Qtà	UM	GN1181A0	GUARNIZIONE CERN VETRO INT CR1085-1086	1	PZ	V11810A0	VITE NO TESTA EI M6X6 TESTA PIANA INOX	3	PZ	VM1224A0	TUBOLARE TERMORETR 65MY 220MM 2 COLORI	0.200	M
Codice	Descrizione	Qtà	UM																		
GN1181A0	GUARNIZIONE CERN VETRO INT CR1085-1086	1	PZ																		
V11810A0	VITE NO TESTA EI M6X6 TESTA PIANA INOX	3	PZ																		
VM1224A0	TUBOLARE TERMORETR 65MY 220MM 2 COLORI	0.200	M																		
GN1181A	GUARNIZIONE CERN VETRO INT CR1085-1086		KGN1181A	KIT 2 GUARNIZIONI CERNIERE VETRO INT.	<table border="1"> <thead> <tr> <th>Codice</th> <th>Descrizione</th> <th>Qtà</th> <th>UM</th> </tr> </thead> <tbody> <tr> <td>GN1181A0</td> <td>GUARNIZIONE CERN VETRO INT CR1085-1086</td> <td>2</td> <td>PZ</td> </tr> <tr> <td>VM1224A0</td> <td>TUBOLARE TERMORETR 65MY 220MM 2 COLORI</td> <td>0.200</td> <td>M</td> </tr> </tbody> </table>	Codice	Descrizione	Qtà	UM	GN1181A0	GUARNIZIONE CERN VETRO INT CR1085-1086	2	PZ	VM1224A0	TUBOLARE TERMORETR 65MY 220MM 2 COLORI	0.200	M				
Codice	Descrizione	Qtà	UM																		
GN1181A0	GUARNIZIONE CERN VETRO INT CR1085-1086	2	PZ																		
VM1224A0	TUBOLARE TERMORETR 65MY 220MM 2 COLORI	0.200	M																		
VM2000A	TAPPO COPRIVITE A BRUGOLA M4		VM2000A0	TAPPO COPRIVITE A BRUGOLA M4																	
GN1181A	GUARNIZIONE CERN VETRO INT CR1085-1086		KGN1181A	KIT 2 GUARNIZIONI CERNIERE VETRO INT.	<table border="1"> <thead> <tr> <th>Codice</th> <th>Descrizione</th> <th>Qtà</th> <th>UM</th> </tr> </thead> <tbody> <tr> <td>GN1181A0</td> <td>GUARNIZIONE CERN VETRO INT CR1085-1086</td> <td>2</td> <td>PZ</td> </tr> <tr> <td>VM1224A0</td> <td>TUBOLARE TERMORETR 65MY 220MM 2 COLORI</td> <td>0.200</td> <td>M</td> </tr> </tbody> </table>	Codice	Descrizione	Qtà	UM	GN1181A0	GUARNIZIONE CERN VETRO INT CR1085-1086	2	PZ	VM1224A0	TUBOLARE TERMORETR 65MY 220MM 2 COLORI	0.200	M				
Codice	Descrizione	Qtà	UM																		
GN1181A0	GUARNIZIONE CERN VETRO INT CR1085-1086	2	PZ																		
VM1224A0	TUBOLARE TERMORETR 65MY 220MM 2 COLORI	0.200	M																		
CR1086A	CERNIERA VETRO INT INOX INF		KVM0012A	KIT CONV. APERTURA VETRO INT. S. 4-5-5E	<table border="1"> <thead> <tr> <th>Codice</th> <th>Descrizione</th> <th>Qtà</th> <th>UM</th> </tr> </thead> <tbody> <tr> <td>CR1085A0</td> <td>CERNIERA VETRO INT INOX SUP</td> <td>1</td> <td>PZ</td> </tr> <tr> <td>CR1086A0</td> <td>CERNIERA VETRO INT INOX INF</td> <td>1</td> <td>PZ</td> </tr> </tbody> </table>	Codice	Descrizione	Qtà	UM	CR1085A0	CERNIERA VETRO INT INOX SUP	1	PZ	CR1086A0	CERNIERA VETRO INT INOX INF	1	PZ				
Codice	Descrizione	Qtà	UM																		
CR1085A0	CERNIERA VETRO INT INOX SUP	1	PZ																		
CR1086A0	CERNIERA VETRO INT INOX INF	1	PZ																		

COMPONENTE			RICAMBIO																																										
Codice	Descrizione	Immagine	Codice	Descrizione	Lista componenti																																								
CR1086A	CERNIERA VETRO INT INOX INF		KVM0012A	KIT CONV. APERTURA VETRO INT. S. 4-5-5E	<table border="1"> <thead> <tr> <th>Codice</th> <th>Descrizione</th> <th>Qtà</th> <th>UM</th> </tr> </thead> <tbody> <tr> <td>GN1181A0</td> <td>GUARNIZIONE CERN VETRO INT CR1085-1086</td> <td>2</td> <td>PZ</td> </tr> <tr> <td>VI1220A1</td> <td>VITE AUTOFILETTA NTE 4.2X11 TCS+ MARUTE</td> <td>5</td> <td>PZ</td> </tr> <tr> <td>VI1300A0</td> <td>VITE M6X12 T1/2T+ INOX</td> <td>4</td> <td>PZ</td> </tr> <tr> <td>VI1810A0</td> <td>VITE NO TESTA EI M6X6 TESTA PIANA INOX</td> <td>6</td> <td>PZ</td> </tr> <tr> <td>VI1950A0</td> <td>VITE AUTOFORANT E 4,2X13 TCB INOX</td> <td>6</td> <td>PZ</td> </tr> <tr> <td>VM1224A0</td> <td>TUBOLARE TERMORETR 65MY 220MM 2 COLORI</td> <td>0.300</td> <td>M</td> </tr> <tr> <td>VM1680A0</td> <td>CERNIERA APERTURA VETRO INTERNO</td> <td>2</td> <td>PZ</td> </tr> <tr> <td>VM2042A0</td> <td>ASSIEME CHIUSURA VETRO INTERNO LAT</td> <td>2</td> <td>PZ</td> </tr> <tr> <td>VM2043A0</td> <td>SUPPORTO VETRO SUP - INF</td> <td>2</td> <td>PZ</td> </tr> </tbody> </table>	Codice	Descrizione	Qtà	UM	GN1181A0	GUARNIZIONE CERN VETRO INT CR1085-1086	2	PZ	VI1220A1	VITE AUTOFILETTA NTE 4.2X11 TCS+ MARUTE	5	PZ	VI1300A0	VITE M6X12 T1/2T+ INOX	4	PZ	VI1810A0	VITE NO TESTA EI M6X6 TESTA PIANA INOX	6	PZ	VI1950A0	VITE AUTOFORANT E 4,2X13 TCB INOX	6	PZ	VM1224A0	TUBOLARE TERMORETR 65MY 220MM 2 COLORI	0.300	M	VM1680A0	CERNIERA APERTURA VETRO INTERNO	2	PZ	VM2042A0	ASSIEME CHIUSURA VETRO INTERNO LAT	2	PZ	VM2043A0	SUPPORTO VETRO SUP - INF	2	PZ
			Codice	Descrizione	Qtà	UM																																							
GN1181A0	GUARNIZIONE CERN VETRO INT CR1085-1086	2	PZ																																										
VI1220A1	VITE AUTOFILETTA NTE 4.2X11 TCS+ MARUTE	5	PZ																																										
VI1300A0	VITE M6X12 T1/2T+ INOX	4	PZ																																										
VI1810A0	VITE NO TESTA EI M6X6 TESTA PIANA INOX	6	PZ																																										
VI1950A0	VITE AUTOFORANT E 4,2X13 TCB INOX	6	PZ																																										
VM1224A0	TUBOLARE TERMORETR 65MY 220MM 2 COLORI	0.300	M																																										
VM1680A0	CERNIERA APERTURA VETRO INTERNO	2	PZ																																										
VM2042A0	ASSIEME CHIUSURA VETRO INTERNO LAT	2	PZ																																										
VM2043A0	SUPPORTO VETRO SUP - INF	2	PZ																																										
KCR1086A	KIT CERNIERA VETRO INT INOX INF	<table border="1"> <thead> <tr> <th>Codice</th> <th>Descrizione</th> <th>Qtà</th> <th>UM</th> </tr> </thead> <tbody> <tr> <td>CR1086A0</td> <td>CERNIERA VETRO INT INOX INF</td> <td>1</td> <td>PZ</td> </tr> <tr> <td>GN1181A0</td> <td>GUARNIZIONE CERN VETRO INT CR1085-1086</td> <td>1</td> <td>PZ</td> </tr> <tr> <td>VI1810A0</td> <td>VITE NO TESTA EI M6X6 TESTA PIANA INOX</td> <td>3</td> <td>PZ</td> </tr> <tr> <td>VM1224A0</td> <td>TUBOLARE TERMORETR 65MY 220MM 2 COLORI</td> <td>0.200</td> <td>M</td> </tr> </tbody> </table>	Codice	Descrizione	Qtà	UM	CR1086A0	CERNIERA VETRO INT INOX INF	1	PZ	GN1181A0	GUARNIZIONE CERN VETRO INT CR1085-1086	1	PZ	VI1810A0	VITE NO TESTA EI M6X6 TESTA PIANA INOX	3	PZ	VM1224A0	TUBOLARE TERMORETR 65MY 220MM 2 COLORI	0.200	M																							
Codice	Descrizione	Qtà	UM																																										
CR1086A0	CERNIERA VETRO INT INOX INF	1	PZ																																										
GN1181A0	GUARNIZIONE CERN VETRO INT CR1085-1086	1	PZ																																										
VI1810A0	VITE NO TESTA EI M6X6 TESTA PIANA INOX	3	PZ																																										
VM1224A0	TUBOLARE TERMORETR 65MY 220MM 2 COLORI	0.200	M																																										

COMPONENTE			RICAMBIO																																										
Codice	Descrizione	Immagine	Codice	Descrizione	Lista componenti																																								
VM2008A	DISTANZIALE PER MICROPORTA MEC		KVM2008A	KIT DISTANZIALE PER MICROPORTA MECC	<table border="1"> <thead> <tr> <th>Codice</th> <th>Descrizione</th> <th>Qtà</th> <th>UM</th> </tr> </thead> <tbody> <tr> <td>VM1224A0</td> <td>TUBOLARE TERMORETR 65MY 220MM 2 COLORI</td> <td>0.200</td> <td>M</td> </tr> <tr> <td>VM2008A0</td> <td>DISTANZIALE PER MICROPORTA MECC</td> <td>2</td> <td>PZ</td> </tr> </tbody> </table>	Codice	Descrizione	Qtà	UM	VM1224A0	TUBOLARE TERMORETR 65MY 220MM 2 COLORI	0.200	M	VM2008A0	DISTANZIALE PER MICROPORTA MECC	2	PZ																												
Codice	Descrizione	Qtà	UM																																										
VM1224A0	TUBOLARE TERMORETR 65MY 220MM 2 COLORI	0.200	M																																										
VM2008A0	DISTANZIALE PER MICROPORTA MECC	2	PZ																																										
VM2042A	ASSIEME CHIUSURA VETRO INTERNO LA		KVM2042A	KIT CHIUSURA A MOLLA VETRO INT	<table border="1"> <thead> <tr> <th>Codice</th> <th>Descrizione</th> <th>Qtà</th> <th>UM</th> </tr> </thead> <tbody> <tr> <td>RC1200A0</td> <td>MOLLA A COMPRESSIO NE DE4 DF0.5 H24</td> <td>2</td> <td>PZ</td> </tr> <tr> <td>VI1220A1</td> <td>VITE AUTOFILETTA NTE 4.2X11 TCS+ MARUTE</td> <td>2</td> <td>PZ</td> </tr> <tr> <td>VM1224A0</td> <td>TUBOLARE TERMORETR 65MY 220MM 2 COLORI</td> <td>0.200</td> <td>M</td> </tr> <tr> <td>VM2042A0</td> <td>ASSIEME CHIUSURA VETRO INTERNO LAT</td> <td>1</td> <td>PZ</td> </tr> </tbody> </table>	Codice	Descrizione	Qtà	UM	RC1200A0	MOLLA A COMPRESSIO NE DE4 DF0.5 H24	2	PZ	VI1220A1	VITE AUTOFILETTA NTE 4.2X11 TCS+ MARUTE	2	PZ	VM1224A0	TUBOLARE TERMORETR 65MY 220MM 2 COLORI	0.200	M	VM2042A0	ASSIEME CHIUSURA VETRO INTERNO LAT	1	PZ																				
Codice	Descrizione	Qtà	UM																																										
RC1200A0	MOLLA A COMPRESSIO NE DE4 DF0.5 H24	2	PZ																																										
VI1220A1	VITE AUTOFILETTA NTE 4.2X11 TCS+ MARUTE	2	PZ																																										
VM1224A0	TUBOLARE TERMORETR 65MY 220MM 2 COLORI	0.200	M																																										
VM2042A0	ASSIEME CHIUSURA VETRO INTERNO LAT	1	PZ																																										
VM1620A	SUPPORTO INF BARRA LED		KLP1044A	KIT BARRA ILLUMINAZIONE LED LUX	<table border="1"> <thead> <tr> <th>Codice</th> <th>Descrizione</th> <th>Qtà</th> <th>UM</th> </tr> </thead> <tbody> <tr> <td>CE1455A0</td> <td>TERMINALE A PUNTALE</td> <td>2</td> <td>PZ</td> </tr> <tr> <td>CE1730A0</td> <td>CAVO PVC NP 2 X AWG22 STYLE 2095</td> <td>4.500</td> <td>M</td> </tr> <tr> <td>CE1735A0</td> <td>TERMINALE MINIFIT FEMMINA</td> <td>2</td> <td>PZ</td> </tr> <tr> <td>CE1740A0</td> <td>TERMINALE MINIFIT MASCHIO</td> <td>4</td> <td>PZ</td> </tr> <tr> <td>CE1745A0</td> <td>CONNETTORE MINIFIT FEMMINA 2 VI</td> <td>2</td> <td>PZ</td> </tr> <tr> <td>CE1750A0</td> <td>CONNETTORE MINIFIT MASCHIO 3 VI</td> <td>1</td> <td>PZ</td> </tr> <tr> <td>LP1044A0</td> <td>BARRA ILLUMINAZIONE LED LUX</td> <td>1</td> <td>PZ</td> </tr> <tr> <td>VM1620A0</td> <td>SUPPORTO INF BARRA LE</td> <td>1</td> <td>PZ</td> </tr> <tr> <td>VM1621A0</td> <td>SUPPORTO SUP BARRA LED</td> <td>1</td> <td>PZ</td> </tr> </tbody> </table>	Codice	Descrizione	Qtà	UM	CE1455A0	TERMINALE A PUNTALE	2	PZ	CE1730A0	CAVO PVC NP 2 X AWG22 STYLE 2095	4.500	M	CE1735A0	TERMINALE MINIFIT FEMMINA	2	PZ	CE1740A0	TERMINALE MINIFIT MASCHIO	4	PZ	CE1745A0	CONNETTORE MINIFIT FEMMINA 2 VI	2	PZ	CE1750A0	CONNETTORE MINIFIT MASCHIO 3 VI	1	PZ	LP1044A0	BARRA ILLUMINAZIONE LED LUX	1	PZ	VM1620A0	SUPPORTO INF BARRA LE	1	PZ	VM1621A0	SUPPORTO SUP BARRA LED	1	PZ
Codice	Descrizione	Qtà	UM																																										
CE1455A0	TERMINALE A PUNTALE	2	PZ																																										
CE1730A0	CAVO PVC NP 2 X AWG22 STYLE 2095	4.500	M																																										
CE1735A0	TERMINALE MINIFIT FEMMINA	2	PZ																																										
CE1740A0	TERMINALE MINIFIT MASCHIO	4	PZ																																										
CE1745A0	CONNETTORE MINIFIT FEMMINA 2 VI	2	PZ																																										
CE1750A0	CONNETTORE MINIFIT MASCHIO 3 VI	1	PZ																																										
LP1044A0	BARRA ILLUMINAZIONE LED LUX	1	PZ																																										
VM1620A0	SUPPORTO INF BARRA LE	1	PZ																																										
VM1621A0	SUPPORTO SUP BARRA LED	1	PZ																																										

COMPONENTE			RICAMBIO																																											
Codice	Descrizione	Immagine	Codice	Descrizione	Lista componenti																																									
VM1620A	SUPPORTO INF BARRA LED		KLP1007A	KIT BARRA LED L200	<table border="1"> <thead> <tr> <th>Codice</th> <th>Descrizione</th> <th>Qtà</th> <th>UM</th> </tr> </thead> <tbody> <tr> <td>CE1455A0</td> <td>TERMINALE A PUNTALE</td> <td>2</td> <td>PZ</td> </tr> <tr> <td>CE1730A0</td> <td>CAVO PVC NP 2 X AWG22 STYLE 2095</td> <td>4.500</td> <td>M</td> </tr> <tr> <td>CE1735A0</td> <td>TERMINALE MINIFIT FEMMINA</td> <td>2</td> <td>PZ</td> </tr> <tr> <td>CE1740A0</td> <td>TERMINALE MINIFIT MASCHIO</td> <td>4</td> <td>PZ</td> </tr> <tr> <td>CE1745A0</td> <td>CONNETTORE MINIFIT FEMMINA 2 VI</td> <td>2</td> <td>PZ</td> </tr> <tr> <td>CE1750A0</td> <td>CONNETTORE MINIFIT MASCHIO 3 VI</td> <td>1</td> <td>PZ</td> </tr> <tr> <td>LP1007A0</td> <td>BARRA ILLUMINAZION E LED L200</td> <td>1</td> <td>PZ</td> </tr> <tr> <td>VM1620A0</td> <td>SUPPORTO INF BARRA LE</td> <td>1</td> <td>PZ</td> </tr> <tr> <td>VM1621A0</td> <td>SUPPORTO SUP BARRA LED</td> <td>1</td> <td>PZ</td> </tr> </tbody> </table>	Codice	Descrizione	Qtà	UM	CE1455A0	TERMINALE A PUNTALE	2	PZ	CE1730A0	CAVO PVC NP 2 X AWG22 STYLE 2095	4.500	M	CE1735A0	TERMINALE MINIFIT FEMMINA	2	PZ	CE1740A0	TERMINALE MINIFIT MASCHIO	4	PZ	CE1745A0	CONNETTORE MINIFIT FEMMINA 2 VI	2	PZ	CE1750A0	CONNETTORE MINIFIT MASCHIO 3 VI	1	PZ	LP1007A0	BARRA ILLUMINAZION E LED L200	1	PZ	VM1620A0	SUPPORTO INF BARRA LE	1	PZ	VM1621A0	SUPPORTO SUP BARRA LED	1	PZ	
			Codice	Descrizione	Qtà	UM																																								
CE1455A0	TERMINALE A PUNTALE	2	PZ																																											
CE1730A0	CAVO PVC NP 2 X AWG22 STYLE 2095	4.500	M																																											
CE1735A0	TERMINALE MINIFIT FEMMINA	2	PZ																																											
CE1740A0	TERMINALE MINIFIT MASCHIO	4	PZ																																											
CE1745A0	CONNETTORE MINIFIT FEMMINA 2 VI	2	PZ																																											
CE1750A0	CONNETTORE MINIFIT MASCHIO 3 VI	1	PZ																																											
LP1007A0	BARRA ILLUMINAZION E LED L200	1	PZ																																											
VM1620A0	SUPPORTO INF BARRA LE	1	PZ																																											
VM1621A0	SUPPORTO SUP BARRA LED	1	PZ																																											
KLP1004B	KIT RICAMBIO BARRA LED L1000	<table border="1"> <thead> <tr> <th>Codice</th> <th>Descrizione</th> <th>Qtà</th> <th>UM</th> </tr> </thead> <tbody> <tr> <td>CE1730A0</td> <td>CAVO PVC NP 2 X AWG22 STYLE 2095</td> <td>1</td> <td>M</td> </tr> <tr> <td>CE1735A0</td> <td>TERMINALE MINIFIT FEMMINA</td> <td>2</td> <td>PZ</td> </tr> <tr> <td>CE1740A0</td> <td>TERMINALE MINIFIT MASCHIO</td> <td>2</td> <td>PZ</td> </tr> <tr> <td>CE1745A0</td> <td>CONNETTORE MINIFIT FEMMINA 2 VI</td> <td>1</td> <td>PZ</td> </tr> <tr> <td>CE1750A0</td> <td>CONNETTORE MINIFIT MASCHIO 3 VI</td> <td>1</td> <td>PZ</td> </tr> <tr> <td>IP1385A1</td> <td>IMB POL ANGOLARE 110X80X2000 D30</td> <td>2.200</td> <td>M</td> </tr> <tr> <td>LP1004B0</td> <td>BARRA ILLUMINAZION E LED L1000</td> <td>1</td> <td>PZ</td> </tr> <tr> <td>VM1059A1</td> <td>FILM TERMORETRA IBILE H800</td> <td>1.300</td> <td>M</td> </tr> <tr> <td>VM1620A0</td> <td>SUPPORTO INF BARRA LE</td> <td>1</td> <td>PZ</td> </tr> <tr> <td>VM1621A0</td> <td>SUPPORTO SUP BARRA LED</td> <td>1</td> <td>PZ</td> </tr> </tbody> </table>	Codice	Descrizione	Qtà	UM	CE1730A0	CAVO PVC NP 2 X AWG22 STYLE 2095	1	M	CE1735A0	TERMINALE MINIFIT FEMMINA	2	PZ	CE1740A0	TERMINALE MINIFIT MASCHIO	2	PZ	CE1745A0	CONNETTORE MINIFIT FEMMINA 2 VI	1	PZ	CE1750A0	CONNETTORE MINIFIT MASCHIO 3 VI	1	PZ	IP1385A1	IMB POL ANGOLARE 110X80X2000 D30	2.200	M	LP1004B0	BARRA ILLUMINAZION E LED L1000	1	PZ	VM1059A1	FILM TERMORETRA IBILE H800	1.300	M	VM1620A0	SUPPORTO INF BARRA LE	1	PZ	VM1621A0	SUPPORTO SUP BARRA LED	1	PZ
Codice	Descrizione	Qtà	UM																																											
CE1730A0	CAVO PVC NP 2 X AWG22 STYLE 2095	1	M																																											
CE1735A0	TERMINALE MINIFIT FEMMINA	2	PZ																																											
CE1740A0	TERMINALE MINIFIT MASCHIO	2	PZ																																											
CE1745A0	CONNETTORE MINIFIT FEMMINA 2 VI	1	PZ																																											
CE1750A0	CONNETTORE MINIFIT MASCHIO 3 VI	1	PZ																																											
IP1385A1	IMB POL ANGOLARE 110X80X2000 D30	2.200	M																																											
LP1004B0	BARRA ILLUMINAZION E LED L1000	1	PZ																																											
VM1059A1	FILM TERMORETRA IBILE H800	1.300	M																																											
VM1620A0	SUPPORTO INF BARRA LE	1	PZ																																											
VM1621A0	SUPPORTO SUP BARRA LED	1	PZ																																											

COMPONENTE			RICAMBIO																																														
Codice	Descrizione	Immagine	Codice	Descrizione	Lista componenti																																												
VM1620A	SUPPORTO INF BARRA LED		KLP1003B	KIT RICAMBIO BARRA LED L600	<table border="1"> <thead> <tr> <th>Codice</th> <th>Descrizione</th> <th>Qtà</th> <th>UM</th> </tr> </thead> <tbody> <tr> <td>CE1730A0</td> <td>CAVO PVC NP 2 X AWG22 STYLE 2095</td> <td>1</td> <td>M</td> </tr> <tr> <td>CE1735A0</td> <td>TERMINALE MINIFIT FEMMINA</td> <td>2</td> <td>PZ</td> </tr> <tr> <td>CE1740A0</td> <td>TERMINALE MINIFIT MASCHIO</td> <td>2</td> <td>PZ</td> </tr> <tr> <td>CE1745A0</td> <td>CONNETTORE MINIFIT FEMMINA 2 VI</td> <td>1</td> <td>PZ</td> </tr> <tr> <td>CE1750A0</td> <td>CONNETTORE MINIFIT MASCHIO 3 VI</td> <td>1</td> <td>PZ</td> </tr> <tr> <td>LP1003B0</td> <td>BARRA ILLUMINAZION E LED L600</td> <td>1</td> <td>PZ</td> </tr> <tr> <td>VM1620A0</td> <td>SUPPORTO INF BARRA LE</td> <td>1</td> <td>PZ</td> </tr> <tr> <td>VM1621A0</td> <td>SUPPORTO SUP BARRA LED</td> <td>1</td> <td>PZ</td> </tr> <tr> <td>VM1794A0</td> <td>FASCETTA 430X4.8 PA66 NERA</td> <td>2</td> <td>PZ</td> </tr> <tr> <td>VM2103A0</td> <td>PIASTRINA FERMAFASCE TTA</td> <td>2</td> <td>PZ</td> </tr> </tbody> </table>	Codice	Descrizione	Qtà	UM	CE1730A0	CAVO PVC NP 2 X AWG22 STYLE 2095	1	M	CE1735A0	TERMINALE MINIFIT FEMMINA	2	PZ	CE1740A0	TERMINALE MINIFIT MASCHIO	2	PZ	CE1745A0	CONNETTORE MINIFIT FEMMINA 2 VI	1	PZ	CE1750A0	CONNETTORE MINIFIT MASCHIO 3 VI	1	PZ	LP1003B0	BARRA ILLUMINAZION E LED L600	1	PZ	VM1620A0	SUPPORTO INF BARRA LE	1	PZ	VM1621A0	SUPPORTO SUP BARRA LED	1	PZ	VM1794A0	FASCETTA 430X4.8 PA66 NERA	2	PZ	VM2103A0	PIASTRINA FERMAFASCE TTA	2	PZ
			Codice	Descrizione	Qtà	UM																																											
CE1730A0	CAVO PVC NP 2 X AWG22 STYLE 2095	1	M																																														
CE1735A0	TERMINALE MINIFIT FEMMINA	2	PZ																																														
CE1740A0	TERMINALE MINIFIT MASCHIO	2	PZ																																														
CE1745A0	CONNETTORE MINIFIT FEMMINA 2 VI	1	PZ																																														
CE1750A0	CONNETTORE MINIFIT MASCHIO 3 VI	1	PZ																																														
LP1003B0	BARRA ILLUMINAZION E LED L600	1	PZ																																														
VM1620A0	SUPPORTO INF BARRA LE	1	PZ																																														
VM1621A0	SUPPORTO SUP BARRA LED	1	PZ																																														
VM1794A0	FASCETTA 430X4.8 PA66 NERA	2	PZ																																														
VM2103A0	PIASTRINA FERMAFASCE TTA	2	PZ																																														
KLP1002B	KIT RICAMBIO BARRA LED L400	<table border="1"> <thead> <tr> <th>Codice</th> <th>Descrizione</th> <th>Qtà</th> <th>UM</th> </tr> </thead> <tbody> <tr> <td>CE1455A0</td> <td>TERMINALE A PUNTALE</td> <td>2</td> <td>PZ</td> </tr> <tr> <td>CE1730A0</td> <td>CAVO PVC NP 2 X AWG22 STYLE 2095</td> <td>4.500</td> <td>M</td> </tr> <tr> <td>CE1735A0</td> <td>TERMINALE MINIFIT FEMMINA</td> <td>2</td> <td>PZ</td> </tr> <tr> <td>CE1740A0</td> <td>TERMINALE MINIFIT MASCHIO</td> <td>4</td> <td>PZ</td> </tr> <tr> <td>CE1745A0</td> <td>CONNETTORE MINIFIT FEMMINA 2 VI</td> <td>2</td> <td>PZ</td> </tr> <tr> <td>CE1750A0</td> <td>CONNETTORE MINIFIT MASCHIO 3 VI</td> <td>1</td> <td>PZ</td> </tr> <tr> <td>LP1002B0</td> <td>BARRA ILLUMINAZION E LED L400</td> <td>1</td> <td>PZ</td> </tr> <tr> <td>VM1620A0</td> <td>SUPPORTO INF BARRA LE</td> <td>1</td> <td>PZ</td> </tr> <tr> <td>VM1621A0</td> <td>SUPPORTO SUP BARRA LED</td> <td>1</td> <td>PZ</td> </tr> </tbody> </table>	Codice	Descrizione	Qtà	UM	CE1455A0	TERMINALE A PUNTALE	2	PZ	CE1730A0	CAVO PVC NP 2 X AWG22 STYLE 2095	4.500	M	CE1735A0	TERMINALE MINIFIT FEMMINA	2	PZ	CE1740A0	TERMINALE MINIFIT MASCHIO	4	PZ	CE1745A0	CONNETTORE MINIFIT FEMMINA 2 VI	2	PZ	CE1750A0	CONNETTORE MINIFIT MASCHIO 3 VI	1	PZ	LP1002B0	BARRA ILLUMINAZION E LED L400	1	PZ	VM1620A0	SUPPORTO INF BARRA LE	1	PZ	VM1621A0	SUPPORTO SUP BARRA LED	1	PZ							
Codice	Descrizione	Qtà	UM																																														
CE1455A0	TERMINALE A PUNTALE	2	PZ																																														
CE1730A0	CAVO PVC NP 2 X AWG22 STYLE 2095	4.500	M																																														
CE1735A0	TERMINALE MINIFIT FEMMINA	2	PZ																																														
CE1740A0	TERMINALE MINIFIT MASCHIO	4	PZ																																														
CE1745A0	CONNETTORE MINIFIT FEMMINA 2 VI	2	PZ																																														
CE1750A0	CONNETTORE MINIFIT MASCHIO 3 VI	1	PZ																																														
LP1002B0	BARRA ILLUMINAZION E LED L400	1	PZ																																														
VM1620A0	SUPPORTO INF BARRA LE	1	PZ																																														
VM1621A0	SUPPORTO SUP BARRA LED	1	PZ																																														

COMPONENTE			RICAMBIO																																										
Codice	Descrizione	Immagine	Codice	Descrizione	Lista componenti																																								
VM1620A	SUPPORTO INF BARRA LED		KLP1001B	KIT RICAMBIO BARRA LED L300	<table border="1"> <thead> <tr> <th>Codice</th> <th>Descrizione</th> <th>Qtà</th> <th>UM</th> </tr> </thead> <tbody> <tr> <td>CE1455A0</td> <td>TERMINALE A PUNTALE</td> <td>2</td> <td>PZ</td> </tr> <tr> <td>CE1730A0</td> <td>CAVO PVC NP 2 X AWG22 STYLE 2095</td> <td>4.500</td> <td>M</td> </tr> <tr> <td>CE1735A0</td> <td>TERMINALE MINIFIT FEMMINA</td> <td>2</td> <td>PZ</td> </tr> <tr> <td>CE1740A0</td> <td>TERMINALE MINIFIT MASCHIO</td> <td>4</td> <td>PZ</td> </tr> <tr> <td>CE1745A0</td> <td>CONNETTORE MINIFIT FEMMINA 2 VI</td> <td>2</td> <td>PZ</td> </tr> <tr> <td>CE1750A0</td> <td>CONNETTORE MINIFIT MASCHIO 3 VI</td> <td>1</td> <td>PZ</td> </tr> <tr> <td>LP1001B0</td> <td>BARRA ILLUMINAZION E LED L300</td> <td>1</td> <td>PZ</td> </tr> <tr> <td>VM1620A0</td> <td>SUPPORTO INF BARRA LE</td> <td>1</td> <td>PZ</td> </tr> <tr> <td>VM1621A0</td> <td>SUPPORTO SUP BARRA LED</td> <td>1</td> <td>PZ</td> </tr> </tbody> </table>	Codice	Descrizione	Qtà	UM	CE1455A0	TERMINALE A PUNTALE	2	PZ	CE1730A0	CAVO PVC NP 2 X AWG22 STYLE 2095	4.500	M	CE1735A0	TERMINALE MINIFIT FEMMINA	2	PZ	CE1740A0	TERMINALE MINIFIT MASCHIO	4	PZ	CE1745A0	CONNETTORE MINIFIT FEMMINA 2 VI	2	PZ	CE1750A0	CONNETTORE MINIFIT MASCHIO 3 VI	1	PZ	LP1001B0	BARRA ILLUMINAZION E LED L300	1	PZ	VM1620A0	SUPPORTO INF BARRA LE	1	PZ	VM1621A0	SUPPORTO SUP BARRA LED	1	PZ
			Codice	Descrizione	Qtà	UM																																							
CE1455A0	TERMINALE A PUNTALE	2	PZ																																										
CE1730A0	CAVO PVC NP 2 X AWG22 STYLE 2095	4.500	M																																										
CE1735A0	TERMINALE MINIFIT FEMMINA	2	PZ																																										
CE1740A0	TERMINALE MINIFIT MASCHIO	4	PZ																																										
CE1745A0	CONNETTORE MINIFIT FEMMINA 2 VI	2	PZ																																										
CE1750A0	CONNETTORE MINIFIT MASCHIO 3 VI	1	PZ																																										
LP1001B0	BARRA ILLUMINAZION E LED L300	1	PZ																																										
VM1620A0	SUPPORTO INF BARRA LE	1	PZ																																										
VM1621A0	SUPPORTO SUP BARRA LED	1	PZ																																										
KLP1000A	KIT RICAMBIO BARRA LED L100	<table border="1"> <thead> <tr> <th>Codice</th> <th>Descrizione</th> <th>Qtà</th> <th>UM</th> </tr> </thead> <tbody> <tr> <td>LP1000A0</td> <td>BARRA ILLUMINAZION E LED L100</td> <td>1</td> <td>PZ</td> </tr> <tr> <td>VM1620A0</td> <td>SUPPORTO INF BARRA LE</td> <td>1</td> <td>PZ</td> </tr> <tr> <td>VM1621A0</td> <td>SUPPORTO SUP BARRA LED</td> <td>1</td> <td>PZ</td> </tr> </tbody> </table>	Codice	Descrizione	Qtà	UM	LP1000A0	BARRA ILLUMINAZION E LED L100	1	PZ	VM1620A0	SUPPORTO INF BARRA LE	1	PZ	VM1621A0	SUPPORTO SUP BARRA LED	1	PZ																											
Codice	Descrizione	Qtà	UM																																										
LP1000A0	BARRA ILLUMINAZION E LED L100	1	PZ																																										
VM1620A0	SUPPORTO INF BARRA LE	1	PZ																																										
VM1621A0	SUPPORTO SUP BARRA LED	1	PZ																																										
VM1621A	SUPPORTO SUP BARRA LED		KLP1044A	KIT BARRA ILLUMINAZIONE LED LUX	<table border="1"> <thead> <tr> <th>Codice</th> <th>Descrizione</th> <th>Qtà</th> <th>UM</th> </tr> </thead> <tbody> <tr> <td>CE1455A0</td> <td>TERMINALE A PUNTALE</td> <td>2</td> <td>PZ</td> </tr> <tr> <td>CE1730A0</td> <td>CAVO PVC NP 2 X AWG22 STYLE 2095</td> <td>4.500</td> <td>M</td> </tr> <tr> <td>CE1735A0</td> <td>TERMINALE MINIFIT FEMMINA</td> <td>2</td> <td>PZ</td> </tr> <tr> <td>CE1740A0</td> <td>TERMINALE MINIFIT MASCHIO</td> <td>4</td> <td>PZ</td> </tr> <tr> <td>CE1745A0</td> <td>CONNETTORE MINIFIT FEMMINA 2 VI</td> <td>2</td> <td>PZ</td> </tr> <tr> <td>CE1750A0</td> <td>CONNETTORE MINIFIT MASCHIO 3 VI</td> <td>1</td> <td>PZ</td> </tr> </tbody> </table>	Codice	Descrizione	Qtà	UM	CE1455A0	TERMINALE A PUNTALE	2	PZ	CE1730A0	CAVO PVC NP 2 X AWG22 STYLE 2095	4.500	M	CE1735A0	TERMINALE MINIFIT FEMMINA	2	PZ	CE1740A0	TERMINALE MINIFIT MASCHIO	4	PZ	CE1745A0	CONNETTORE MINIFIT FEMMINA 2 VI	2	PZ	CE1750A0	CONNETTORE MINIFIT MASCHIO 3 VI	1	PZ												
Codice	Descrizione	Qtà	UM																																										
CE1455A0	TERMINALE A PUNTALE	2	PZ																																										
CE1730A0	CAVO PVC NP 2 X AWG22 STYLE 2095	4.500	M																																										
CE1735A0	TERMINALE MINIFIT FEMMINA	2	PZ																																										
CE1740A0	TERMINALE MINIFIT MASCHIO	4	PZ																																										
CE1745A0	CONNETTORE MINIFIT FEMMINA 2 VI	2	PZ																																										
CE1750A0	CONNETTORE MINIFIT MASCHIO 3 VI	1	PZ																																										

COMPONENTE			RICAMBIO																																							
Codice	Descrizione	Immagine	Codice	Descrizione	Lista componenti																																					
VM1621A	SUPPORTO SUP BARRA LED		KLP1044A	KIT BARRA ILLUMINAZIONE LED LUX	<table border="1"> <thead> <tr> <th>Codice</th> <th>Descrizione</th> <th>Qtà</th> <th>UM</th> </tr> </thead> <tbody> <tr> <td>LP1044A0</td> <td>BARRA ILLUMINAZION E LED LUX</td> <td>1</td> <td>PZ</td> </tr> <tr> <td>VM1620A0</td> <td>SUPPORTO INF BARRA LE</td> <td>1</td> <td>PZ</td> </tr> <tr> <td>VM1621A0</td> <td>SUPPORTO SUP BARRA LED</td> <td>1</td> <td>PZ</td> </tr> </tbody> </table>	Codice	Descrizione	Qtà	UM	LP1044A0	BARRA ILLUMINAZION E LED LUX	1	PZ	VM1620A0	SUPPORTO INF BARRA LE	1	PZ	VM1621A0	SUPPORTO SUP BARRA LED	1	PZ																					
			Codice	Descrizione	Qtà	UM																																				
			LP1044A0	BARRA ILLUMINAZION E LED LUX	1	PZ																																				
VM1620A0	SUPPORTO INF BARRA LE	1	PZ																																							
VM1621A0	SUPPORTO SUP BARRA LED	1	PZ																																							
KLP1007A	KIT BARRA LED L200	<table border="1"> <thead> <tr> <th>Codice</th> <th>Descrizione</th> <th>Qtà</th> <th>UM</th> </tr> </thead> <tbody> <tr> <td>CE1455A0</td> <td>TERMINALE A PUNTALE</td> <td>2</td> <td>PZ</td> </tr> <tr> <td>CE1730A0</td> <td>CAVO PVC NP 2 X AWG22 STYLE 2095</td> <td>4.500</td> <td>M</td> </tr> <tr> <td>CE1735A0</td> <td>TERMINALE MINIFIT FEMMINA</td> <td>2</td> <td>PZ</td> </tr> <tr> <td>CE1740A0</td> <td>TERMINALE MINIFIT MASCHIO</td> <td>4</td> <td>PZ</td> </tr> <tr> <td>CE1745A0</td> <td>CONNETTORE MINIFIT FEMMINA 2 VI</td> <td>2</td> <td>PZ</td> </tr> <tr> <td>CE1750A0</td> <td>CONNETTORE MINIFIT MASCHIO 3 VI</td> <td>1</td> <td>PZ</td> </tr> <tr> <td>LP1007A0</td> <td>BARRA ILLUMINAZION E LED L200</td> <td>1</td> <td>PZ</td> </tr> <tr> <td>VM1620A0</td> <td>SUPPORTO INF BARRA LE</td> <td>1</td> <td>PZ</td> </tr> <tr> <td>VM1621A0</td> <td>SUPPORTO SUP BARRA LED</td> <td>1</td> <td>PZ</td> </tr> </tbody> </table>	Codice	Descrizione	Qtà	UM	CE1455A0	TERMINALE A PUNTALE	2	PZ	CE1730A0	CAVO PVC NP 2 X AWG22 STYLE 2095	4.500	M	CE1735A0	TERMINALE MINIFIT FEMMINA	2	PZ	CE1740A0	TERMINALE MINIFIT MASCHIO	4	PZ	CE1745A0	CONNETTORE MINIFIT FEMMINA 2 VI	2	PZ	CE1750A0	CONNETTORE MINIFIT MASCHIO 3 VI	1	PZ	LP1007A0	BARRA ILLUMINAZION E LED L200	1	PZ	VM1620A0	SUPPORTO INF BARRA LE	1	PZ	VM1621A0	SUPPORTO SUP BARRA LED	1	PZ
Codice	Descrizione	Qtà	UM																																							
CE1455A0	TERMINALE A PUNTALE	2	PZ																																							
CE1730A0	CAVO PVC NP 2 X AWG22 STYLE 2095	4.500	M																																							
CE1735A0	TERMINALE MINIFIT FEMMINA	2	PZ																																							
CE1740A0	TERMINALE MINIFIT MASCHIO	4	PZ																																							
CE1745A0	CONNETTORE MINIFIT FEMMINA 2 VI	2	PZ																																							
CE1750A0	CONNETTORE MINIFIT MASCHIO 3 VI	1	PZ																																							
LP1007A0	BARRA ILLUMINAZION E LED L200	1	PZ																																							
VM1620A0	SUPPORTO INF BARRA LE	1	PZ																																							
VM1621A0	SUPPORTO SUP BARRA LED	1	PZ																																							
KLP1004B	KIT RICAMBIO BARRA LED L1000	<table border="1"> <thead> <tr> <th>Codice</th> <th>Descrizione</th> <th>Qtà</th> <th>UM</th> </tr> </thead> <tbody> <tr> <td>CE1730A0</td> <td>CAVO PVC NP 2 X AWG22 STYLE 2095</td> <td>1</td> <td>M</td> </tr> <tr> <td>CE1735A0</td> <td>TERMINALE MINIFIT FEMMINA</td> <td>2</td> <td>PZ</td> </tr> <tr> <td>CE1740A0</td> <td>TERMINALE MINIFIT MASCHIO</td> <td>2</td> <td>PZ</td> </tr> <tr> <td>CE1745A0</td> <td>CONNETTORE MINIFIT FEMMINA 2 VI</td> <td>1</td> <td>PZ</td> </tr> <tr> <td>CE1750A0</td> <td>CONNETTORE MINIFIT MASCHIO 3 VI</td> <td>1</td> <td>PZ</td> </tr> </tbody> </table>	Codice	Descrizione	Qtà	UM	CE1730A0	CAVO PVC NP 2 X AWG22 STYLE 2095	1	M	CE1735A0	TERMINALE MINIFIT FEMMINA	2	PZ	CE1740A0	TERMINALE MINIFIT MASCHIO	2	PZ	CE1745A0	CONNETTORE MINIFIT FEMMINA 2 VI	1	PZ	CE1750A0	CONNETTORE MINIFIT MASCHIO 3 VI	1	PZ																
Codice	Descrizione	Qtà	UM																																							
CE1730A0	CAVO PVC NP 2 X AWG22 STYLE 2095	1	M																																							
CE1735A0	TERMINALE MINIFIT FEMMINA	2	PZ																																							
CE1740A0	TERMINALE MINIFIT MASCHIO	2	PZ																																							
CE1745A0	CONNETTORE MINIFIT FEMMINA 2 VI	1	PZ																																							
CE1750A0	CONNETTORE MINIFIT MASCHIO 3 VI	1	PZ																																							

COMPONENTE			RICAMBIO																																											
Codice	Descrizione	Immagine	Codice	Descrizione	Lista componenti																																									
VM1621A	SUPPORTO SUP BARRA LED		KLP1004B	KIT RICAMBIO BARRA LED L1000	<table border="1"> <thead> <tr> <th>Codice</th> <th>Descrizione</th> <th>Qtà</th> <th>UM</th> </tr> </thead> <tbody> <tr> <td>IP1385A1</td> <td>IMB POL ANGOLARE 110X80X2000 D30</td> <td>2.200</td> <td>M</td> </tr> <tr> <td>LP1004B0</td> <td>BARRA ILLUMINAZION E LED L1000</td> <td>1</td> <td>PZ</td> </tr> <tr> <td>VM1059A1</td> <td>FILM TERMORETRA IBILE H800</td> <td>1.300</td> <td>M</td> </tr> <tr> <td>VM1620A0</td> <td>SUPPORTO INF BARRA LE</td> <td>1</td> <td>PZ</td> </tr> <tr> <td>VM1621A0</td> <td>SUPPORTO SUP BARRA LED</td> <td>1</td> <td>PZ</td> </tr> </tbody> </table>	Codice	Descrizione	Qtà	UM	IP1385A1	IMB POL ANGOLARE 110X80X2000 D30	2.200	M	LP1004B0	BARRA ILLUMINAZION E LED L1000	1	PZ	VM1059A1	FILM TERMORETRA IBILE H800	1.300	M	VM1620A0	SUPPORTO INF BARRA LE	1	PZ	VM1621A0	SUPPORTO SUP BARRA LED	1	PZ																	
			Codice	Descrizione	Qtà	UM																																								
			IP1385A1	IMB POL ANGOLARE 110X80X2000 D30	2.200	M																																								
LP1004B0	BARRA ILLUMINAZION E LED L1000	1	PZ																																											
VM1059A1	FILM TERMORETRA IBILE H800	1.300	M																																											
VM1620A0	SUPPORTO INF BARRA LE	1	PZ																																											
VM1621A0	SUPPORTO SUP BARRA LED	1	PZ																																											
KLP1003B	KIT RICAMBIO BARRA LED L600	<table border="1"> <thead> <tr> <th>Codice</th> <th>Descrizione</th> <th>Qtà</th> <th>UM</th> </tr> </thead> <tbody> <tr> <td>CE1730A0</td> <td>CAVO PVC NP 2 X AWG22 STYLE 2095</td> <td>1</td> <td>M</td> </tr> <tr> <td>CE1735A0</td> <td>TERMINALE MINIFIT FEMMINA</td> <td>2</td> <td>PZ</td> </tr> <tr> <td>CE1740A0</td> <td>TERMINALE MINIFIT MASCIO</td> <td>2</td> <td>PZ</td> </tr> <tr> <td>CE1745A0</td> <td>CONNETTORE MINIFIT FEMMINA 2 VI</td> <td>1</td> <td>PZ</td> </tr> <tr> <td>CE1750A0</td> <td>CONNETTORE MINIFIT MASCIO 3 VI</td> <td>1</td> <td>PZ</td> </tr> <tr> <td>LP1003B0</td> <td>BARRA ILLUMINAZION E LED L600</td> <td>1</td> <td>PZ</td> </tr> <tr> <td>VM1620A0</td> <td>SUPPORTO INF BARRA LE</td> <td>1</td> <td>PZ</td> </tr> <tr> <td>VM1621A0</td> <td>SUPPORTO SUP BARRA LED</td> <td>1</td> <td>PZ</td> </tr> <tr> <td>VM1794A0</td> <td>FASCETTA 430X4.8 PA66 NERA</td> <td>2</td> <td>PZ</td> </tr> <tr> <td>VM2103A0</td> <td>PIASTRINA FERMAFASCE TTA</td> <td>2</td> <td>PZ</td> </tr> </tbody> </table>	Codice	Descrizione	Qtà	UM	CE1730A0	CAVO PVC NP 2 X AWG22 STYLE 2095	1	M	CE1735A0	TERMINALE MINIFIT FEMMINA	2	PZ	CE1740A0	TERMINALE MINIFIT MASCIO	2	PZ	CE1745A0	CONNETTORE MINIFIT FEMMINA 2 VI	1	PZ	CE1750A0	CONNETTORE MINIFIT MASCIO 3 VI	1	PZ	LP1003B0	BARRA ILLUMINAZION E LED L600	1	PZ	VM1620A0	SUPPORTO INF BARRA LE	1	PZ	VM1621A0	SUPPORTO SUP BARRA LED	1	PZ	VM1794A0	FASCETTA 430X4.8 PA66 NERA	2	PZ	VM2103A0	PIASTRINA FERMAFASCE TTA	2	PZ
Codice	Descrizione	Qtà	UM																																											
CE1730A0	CAVO PVC NP 2 X AWG22 STYLE 2095	1	M																																											
CE1735A0	TERMINALE MINIFIT FEMMINA	2	PZ																																											
CE1740A0	TERMINALE MINIFIT MASCIO	2	PZ																																											
CE1745A0	CONNETTORE MINIFIT FEMMINA 2 VI	1	PZ																																											
CE1750A0	CONNETTORE MINIFIT MASCIO 3 VI	1	PZ																																											
LP1003B0	BARRA ILLUMINAZION E LED L600	1	PZ																																											
VM1620A0	SUPPORTO INF BARRA LE	1	PZ																																											
VM1621A0	SUPPORTO SUP BARRA LED	1	PZ																																											
VM1794A0	FASCETTA 430X4.8 PA66 NERA	2	PZ																																											
VM2103A0	PIASTRINA FERMAFASCE TTA	2	PZ																																											
KLP1002B	KIT RICAMBIO BARRA LED L400	<table border="1"> <thead> <tr> <th>Codice</th> <th>Descrizione</th> <th>Qtà</th> <th>UM</th> </tr> </thead> <tbody> <tr> <td>CE1455A0</td> <td>TERMINALE A PUNTALE</td> <td>2</td> <td>PZ</td> </tr> <tr> <td>CE1730A0</td> <td>CAVO PVC NP 2 X AWG22 STYLE 2095</td> <td>4.500</td> <td>M</td> </tr> </tbody> </table>	Codice	Descrizione	Qtà	UM	CE1455A0	TERMINALE A PUNTALE	2	PZ	CE1730A0	CAVO PVC NP 2 X AWG22 STYLE 2095	4.500	M																																
Codice	Descrizione	Qtà	UM																																											
CE1455A0	TERMINALE A PUNTALE	2	PZ																																											
CE1730A0	CAVO PVC NP 2 X AWG22 STYLE 2095	4.500	M																																											

COMPONENTE			RICAMBIO																																							
Codice	Descrizione	Immagine	Codice	Descrizione	Lista componenti																																					
VM1621A	SUPPORTO SUP BARRA LED		KLP1002B	KIT RICAMBIO BARRA LED L400	<table border="1"> <thead> <tr> <th>Codice</th> <th>Descrizione</th> <th>Qtà</th> <th>UM</th> </tr> </thead> <tbody> <tr> <td>CE1735A0</td> <td>TERMINALE MINIFIT FEMMINA</td> <td>2</td> <td>PZ</td> </tr> <tr> <td>CE1740A0</td> <td>TERMINALE MINIFIT MASCHIO</td> <td>4</td> <td>PZ</td> </tr> <tr> <td>CE1745A0</td> <td>CONNETTORE MINIFIT FEMMINA 2 VI</td> <td>2</td> <td>PZ</td> </tr> <tr> <td>CE1750A0</td> <td>CONNETTORE MINIFIT MASCHIO 3 VI</td> <td>1</td> <td>PZ</td> </tr> <tr> <td>LP1002B0</td> <td>BARRA ILLUMINAZION E LED L400</td> <td>1</td> <td>PZ</td> </tr> <tr> <td>VM1620A0</td> <td>SUPPORTO INF BARRA LE</td> <td>1</td> <td>PZ</td> </tr> <tr> <td>VM1621A0</td> <td>SUPPORTO SUP BARRA LED</td> <td>1</td> <td>PZ</td> </tr> </tbody> </table>	Codice	Descrizione	Qtà	UM	CE1735A0	TERMINALE MINIFIT FEMMINA	2	PZ	CE1740A0	TERMINALE MINIFIT MASCHIO	4	PZ	CE1745A0	CONNETTORE MINIFIT FEMMINA 2 VI	2	PZ	CE1750A0	CONNETTORE MINIFIT MASCHIO 3 VI	1	PZ	LP1002B0	BARRA ILLUMINAZION E LED L400	1	PZ	VM1620A0	SUPPORTO INF BARRA LE	1	PZ	VM1621A0	SUPPORTO SUP BARRA LED	1	PZ					
			Codice	Descrizione	Qtà	UM																																				
			CE1735A0	TERMINALE MINIFIT FEMMINA	2	PZ																																				
CE1740A0	TERMINALE MINIFIT MASCHIO	4	PZ																																							
CE1745A0	CONNETTORE MINIFIT FEMMINA 2 VI	2	PZ																																							
CE1750A0	CONNETTORE MINIFIT MASCHIO 3 VI	1	PZ																																							
LP1002B0	BARRA ILLUMINAZION E LED L400	1	PZ																																							
VM1620A0	SUPPORTO INF BARRA LE	1	PZ																																							
VM1621A0	SUPPORTO SUP BARRA LED	1	PZ																																							
KLP1001B	KIT RICAMBIO BARRA LED L300	<table border="1"> <thead> <tr> <th>Codice</th> <th>Descrizione</th> <th>Qtà</th> <th>UM</th> </tr> </thead> <tbody> <tr> <td>CE1455A0</td> <td>TERMINALE A PUNTALE</td> <td>2</td> <td>PZ</td> </tr> <tr> <td>CE1730A0</td> <td>CAVO PVC NP 2 X AWG22 STYLE 2095</td> <td>4.500</td> <td>M</td> </tr> <tr> <td>CE1735A0</td> <td>TERMINALE MINIFIT FEMMINA</td> <td>2</td> <td>PZ</td> </tr> <tr> <td>CE1740A0</td> <td>TERMINALE MINIFIT MASCHIO</td> <td>4</td> <td>PZ</td> </tr> <tr> <td>CE1745A0</td> <td>CONNETTORE MINIFIT FEMMINA 2 VI</td> <td>2</td> <td>PZ</td> </tr> <tr> <td>CE1750A0</td> <td>CONNETTORE MINIFIT MASCHIO 3 VI</td> <td>1</td> <td>PZ</td> </tr> <tr> <td>LP1001B0</td> <td>BARRA ILLUMINAZION E LED L300</td> <td>1</td> <td>PZ</td> </tr> <tr> <td>VM1620A0</td> <td>SUPPORTO INF BARRA LE</td> <td>1</td> <td>PZ</td> </tr> <tr> <td>VM1621A0</td> <td>SUPPORTO SUP BARRA LED</td> <td>1</td> <td>PZ</td> </tr> </tbody> </table>	Codice	Descrizione	Qtà	UM	CE1455A0	TERMINALE A PUNTALE	2	PZ	CE1730A0	CAVO PVC NP 2 X AWG22 STYLE 2095	4.500	M	CE1735A0	TERMINALE MINIFIT FEMMINA	2	PZ	CE1740A0	TERMINALE MINIFIT MASCHIO	4	PZ	CE1745A0	CONNETTORE MINIFIT FEMMINA 2 VI	2	PZ	CE1750A0	CONNETTORE MINIFIT MASCHIO 3 VI	1	PZ	LP1001B0	BARRA ILLUMINAZION E LED L300	1	PZ	VM1620A0	SUPPORTO INF BARRA LE	1	PZ	VM1621A0	SUPPORTO SUP BARRA LED	1	PZ
Codice	Descrizione	Qtà	UM																																							
CE1455A0	TERMINALE A PUNTALE	2	PZ																																							
CE1730A0	CAVO PVC NP 2 X AWG22 STYLE 2095	4.500	M																																							
CE1735A0	TERMINALE MINIFIT FEMMINA	2	PZ																																							
CE1740A0	TERMINALE MINIFIT MASCHIO	4	PZ																																							
CE1745A0	CONNETTORE MINIFIT FEMMINA 2 VI	2	PZ																																							
CE1750A0	CONNETTORE MINIFIT MASCHIO 3 VI	1	PZ																																							
LP1001B0	BARRA ILLUMINAZION E LED L300	1	PZ																																							
VM1620A0	SUPPORTO INF BARRA LE	1	PZ																																							
VM1621A0	SUPPORTO SUP BARRA LED	1	PZ																																							
KLP1000A	KIT RICAMBIO BARRA LED L100	<table border="1"> <thead> <tr> <th>Codice</th> <th>Descrizione</th> <th>Qtà</th> <th>UM</th> </tr> </thead> <tbody> <tr> <td>LP1000A0</td> <td>BARRA ILLUMINAZION E LED L100</td> <td>1</td> <td>PZ</td> </tr> <tr> <td>VM1620A0</td> <td>SUPPORTO INF BARRA LE</td> <td>1</td> <td>PZ</td> </tr> <tr> <td>VM1621A0</td> <td>SUPPORTO SUP BARRA LED</td> <td>1</td> <td>PZ</td> </tr> </tbody> </table>	Codice	Descrizione	Qtà	UM	LP1000A0	BARRA ILLUMINAZION E LED L100	1	PZ	VM1620A0	SUPPORTO INF BARRA LE	1	PZ	VM1621A0	SUPPORTO SUP BARRA LED	1	PZ																								
Codice	Descrizione	Qtà	UM																																							
LP1000A0	BARRA ILLUMINAZION E LED L100	1	PZ																																							
VM1620A0	SUPPORTO INF BARRA LE	1	PZ																																							
VM1621A0	SUPPORTO SUP BARRA LED	1	PZ																																							



COMPONENTE			RICAMBIO																																										
Codice	Descrizione	Immagine	Codice	Descrizione	Lista componenti																																								
LP1044A	BARRA ILLUMINAZIONE LED LUX		KLP1044A	KIT BARRA ILLUMINAZIONE LED LUX	<table border="1"> <thead> <tr> <th>Codice</th> <th>Descrizione</th> <th>Qtà</th> <th>UM</th> </tr> </thead> <tbody> <tr> <td>CE1455A0</td> <td>TERMINALE A PUNTALE</td> <td>2</td> <td>PZ</td> </tr> <tr> <td>CE1730A0</td> <td>CAVO PVC NP 2 X AWG22 STYLE 2095</td> <td>4.500</td> <td>M</td> </tr> <tr> <td>CE1735A0</td> <td>TERMINALE MINIFIT FEMMINA</td> <td>2</td> <td>PZ</td> </tr> <tr> <td>CE1740A0</td> <td>TERMINALE MINIFIT MASCHIO</td> <td>4</td> <td>PZ</td> </tr> <tr> <td>CE1745A0</td> <td>CONNETTORE MINIFIT FEMMINA 2 VI</td> <td>2</td> <td>PZ</td> </tr> <tr> <td>CE1750A0</td> <td>CONNETTORE MINIFIT MASCHIO 3 VI</td> <td>1</td> <td>PZ</td> </tr> <tr> <td>LP1044A0</td> <td>BARRA ILLUMINAZION E LED LUX</td> <td>1</td> <td>PZ</td> </tr> <tr> <td>VM1620A0</td> <td>SUPPORTO INF BARRA LE</td> <td>1</td> <td>PZ</td> </tr> <tr> <td>VM1621A0</td> <td>SUPPORTO SUP BARRA LED</td> <td>1</td> <td>PZ</td> </tr> </tbody> </table>	Codice	Descrizione	Qtà	UM	CE1455A0	TERMINALE A PUNTALE	2	PZ	CE1730A0	CAVO PVC NP 2 X AWG22 STYLE 2095	4.500	M	CE1735A0	TERMINALE MINIFIT FEMMINA	2	PZ	CE1740A0	TERMINALE MINIFIT MASCHIO	4	PZ	CE1745A0	CONNETTORE MINIFIT FEMMINA 2 VI	2	PZ	CE1750A0	CONNETTORE MINIFIT MASCHIO 3 VI	1	PZ	LP1044A0	BARRA ILLUMINAZION E LED LUX	1	PZ	VM1620A0	SUPPORTO INF BARRA LE	1	PZ	VM1621A0	SUPPORTO SUP BARRA LED	1	PZ
Codice	Descrizione	Qtà	UM																																										
CE1455A0	TERMINALE A PUNTALE	2	PZ																																										
CE1730A0	CAVO PVC NP 2 X AWG22 STYLE 2095	4.500	M																																										
CE1735A0	TERMINALE MINIFIT FEMMINA	2	PZ																																										
CE1740A0	TERMINALE MINIFIT MASCHIO	4	PZ																																										
CE1745A0	CONNETTORE MINIFIT FEMMINA 2 VI	2	PZ																																										
CE1750A0	CONNETTORE MINIFIT MASCHIO 3 VI	1	PZ																																										
LP1044A0	BARRA ILLUMINAZION E LED LUX	1	PZ																																										
VM1620A0	SUPPORTO INF BARRA LE	1	PZ																																										
VM1621A0	SUPPORTO SUP BARRA LED	1	PZ																																										